

# RESCUE SYSTEMS 1

Basic Rescue Skills



**INSTRUCTOR  
and STUDENT  
MANUAL**

September 2009



---

# RESCUE SYSTEMS 1

Basic Rescue Skills

Acknowledgements

---



## ACKNOWLEDGMENTS

### **Director Level**

**Del Waters**

*Director, CAL FIRE*

**Matt Bettenhausen**

*Director CAL EMA*

### **Equivalent State Fire Marshal Level**

**Tonya Hoover**

*State Fire Marshal*

**Kim Zagaris**

*Fire Chief, Office of Emergency Services Fire & Rescue Branch, Special Operations*

### **Division Chief Level**

**Mike Richwine**

*Chief, State Fire Training*

**Joe Gear**

*Assistant Chief, Special Operations OES Fire & Rescue Branch*

### **STEAC Chairman**

**Ronny J. Coleman**

### **SFT Staff Person**

**Rodney Slaughter**

*Deputy State Fire Marshal*

### **Committee Members**

**Don Shawver**

*Rescue Training Consultant*

**Sherri Martucci**

*California Fire & Rescue Training Authority*



---

# RESCUE SYSTEMS 1

## Basic Rescue Skills

---



Rescue Systems 1 Curriculum Update Committee

---

## **Rescue Systems 1 Curriculum Update Committee**

Van Riviere / Stockton FD

Jim Pearson / San Bernardino City FD

Jim Mendonsa /

Kevin Southerland / City of Orange FD

Matt Loughran / Fremont FD

Matt O'Donnell Eberts Pass FD

James Bishop / CDF

Don Kelly / City of Sacramento FD

Dan Quiggle / Elk Grove FD

Stan Klopfenstein / Santa Fe Springs FD

Alan Baker / New Port Beach FD

Bob Masonis / New Port Beach FD

John Brenner / City of Sacramento FD

Matt Duaine / Stockton FD

Wes Kitchel / Santa Rosa FD



# RESCUE SYSTEMS 1

## Basic Rescue Skills

### Table of Contents



**STATE FIRE TRAINING MISSION STATEMENT (SFT has this document)**

**REFERENCES – CREDITS – CONTRIBUTORS – TEXTS (SFT has this document)**

**SYLLABUS AND COURSE SCHEDULE (SFT has this document)**

#### **TOPIC 1: INTRODUCTION**

Topic 1-1: The California Urban Search & and Rescue System . . . . .	1
Topic 1-2: Rescue Operations . . . . .	15
Topic 1-3: US&R Safety and Medical Care for Victims . . . . .	31
Topic 1-4: US&R Planning and Preparation . . . . .	47

#### **TOPIC 2: RESCUE KNOTS AND HITCHES**

Topic 2-1: Rescue Knots and Hitches . . . . .	61
Topic 2-2: Anchor Systems . . . . .	71
Topic 2-3: Rescuer and Ambulatory Victim Packaging . . . . .	81
Topic 2-4: System Attachments and Fall Restraint . . . . .	89
Topic 2-5: Belay / Safety Line Systems . . . . .	103
Topic 2-6: Rappelling/Descending . . . . .	111
Topic 2-7: Lower and Raise Main Line Systems Vertical Lower / Raise Systems . . . . .	121

#### **TOPIC 3: LIFTING AND MOVING HEAVY OBJECTS**

Topic 3-1: Introduction to Lifting and Moving Heavy Objects . . . . .	139
---	-----

#### **TOPIC 4: BREAKING AND BREACHING**

Topic 4-1: Introduction to Breaking and Breaching . . . . .	157
---	-----

#### **TOPIC 5: LADDER RESCUE SYSTEMS**

Topic 5-1: Introduction to Ladder Rescue Systems . . . . .	171
--	-----

#### **TOPIC 6: EMERGENCY BUILDING SHORES**

Topic 6-1: Introduction to Structure Shoring Systems . . . . .	187
Topic 6-2: Introduction to Basic Tools & and Equipment for Emergency Shoring Operations . . . . .	203
Topic 6-3: Introduction to the Timber Spot Shore (Class I) . . . . .	207
Topic 6-4: Introduction to the Two- Post Vertical Shore (Class II) . . . . .	211
Topic 6-5: Introduction to the Horizontal Shores . . . . .	217
Topic 6-6: Introduction to the Pre-Constructed Window & and Door Shores . . . . .	221
Topic 6-7: Introduction to the Sloped Surface Shore with Cribbing . . . . .	229
Topic 6-8: Introduction to the Split Sole Raker Shore System . . . . .	235



---

# RESCUE SYSTEMS 1

## Basic Rescue Skills

### Table of Contents

---



#### **TOPIC 6: EMERGENCY BUILDING SHORES (Cont.)**

Topic 6-9: Introduction to the Cutting Station.....	245
<b>APPENDIX A: GLOSSARY.....</b>	<b>A-1</b>
<b>APPENDIX B: ROPE RESCUE SCENE MANAGEMENT.....</b>	<b>B-1</b>
<b>APPENDIX C: SAMPLE CLASS III HARNESS INFORMATION CARD.....</b>	<b>C-1</b>
<b>APPENDIX D: VICTIM CHEST HARNESS INFORMATION CARD.....</b>	<b>D-1</b>
<b>APPENDIX E: VICTIM PELVIC HARNESS INFORMATION CARD.....</b>	<b>E-1</b>



# RESCUE SYSTEMS 1

## Basic Rescue Skills



### Topic 1-1: The California Urban Search and Rescue System

## Topic 1-1: The California Urban Search and Rescue System

**Scope:** This chapter serves as an introduction to the California Urban Search and Rescue System.

**Terminal Learning Objective (TLO):** At the end of this chapter, the student will be familiar with the requirements for the California Urban Search and Rescue (US&R) Basic and Light Operational Levels. The manipulative portion of the course concentrates on techniques to operate safely and effectively at structural collapse incidents involving the collapse or failure of light-frame construction and basic rope rescue situations. The course uses the most innovative and progressive procedures being employed today, while maximizing rescue operation efficiency with minimal equipment and personnel. The Urban Search and Rescue Operational System Description includes four different levels of operational capability, training, and equipment. Additional urban search and rescue multidisciplinary resources are also identified. The document uses the Incident Command System (ICS) to apply common terminology and resource management practices to provide supervision and control of essential functions at incidents that involve technically demanding rescue operations.

**Enabling Learning Objectives (ELO):**

1. Describe the history and objectives of the Rescue Systems 1 course.
2. Describe the California Urban Search and Rescue System.
3. Describe the relevant components of the ICS-US&R 120-1 Operational System.
4. Identify the five general construction categories.

### Course History

The Rescue Systems 1 course was originally developed in 1980 and entitled “Heavy Rescue” as a revision to the United States Department of Defense Manual, Heavy Duty Rescue, No. IG 14-3, 1963. In 1987, the course was updated and retitled “Rescue Systems 1, Fundamentals of Heavy Rescue,” published by the California Office of State Fire Marshal (OSFM), State Fire Training. Funding grants for both of these projects were provided by the Federal Emergency Management Agency (FEMA) and administered by the California Governor’s Office of Emergency Services (OES).

The Rescue Systems 1 course has been used as a model rescue course throughout the nation and abroad. It is often identified in nationally recognized organizations as a required course or a course containing curriculum equivalent to the National Fire Academy (NFA), FEMA, and the National Fire Protection Association (NFPA).

In 1999, the course was updated again and reconfigured so it could be taught in either a modular or continuous schedule format. Funding for the 1999 update was provided by the CDF/State Fire Training.

### Course Objectives

The Rescue Systems 1 course is designed to:

- Provide information on the California Urban Search and Rescue (US&R) System
- Provide information on the rescue capabilities for US&R Basic and Light Operational levels



# RESCUE SYSTEMS 1

## Basic Rescue Skills



### Topic 1-1: The California Urban Search and Rescue System

- Provide training in the rescue disciplines required for the US&R Basic and Light Operational levels
- Provide information on the five types of building construction and their associated hazards relating to building collapse
- Provide information on the four phases of structural collapse rescue
- Provide training in US&R search techniques, including identifying and applying search markings
- Provide information on structural hazard assessment markings

### **The California Urban Search and Rescue System**

The California Urban Search and Rescue (US&R) System was developed to provide a standard for rescue operations and safety practices at urban search and rescue incidents.

### **Firefighting Resources Organized for Potential Emergencies (FIREScope)**

FIREScope's purpose is to deal with mutual aid, cooperative agreements, and fire/rescue regional policy issues, and to advise the Director of OES in matters of statewide importance. The program is administered jointly by OES, the California Department of Forestry and Fire Protection (CAL FIRE), and the OSFM.

The mission of FIREScope is to unify the various fire agencies into one voice and one direction. This group is composed of diverse fire agencies throughout California. The synergy created by these diverse agencies truly provides valuable input to the Director of OES in addressing the future of fire/rescue services in California and ensures excellent representation for the continued development of FIREScope products. The products associated with US&R incidents can be found at [firescope.org](http://firescope.org) and include:

### ***FIREScope ICS-US&R 120-1***

FIREScope ICS-US&R 120-1 identifies the Incident Command System (ICS) structure and the four (4) levels of US&R operational capability, training, and equipment requirements for US&R resources.

- Basic
- Light
- Medium
- Heavy

### ***FIREScope ICS 420-1***

### **Fire Service Field Operations Guide (FOG)**

In addition to containing ICS organizational examples for other types of incidents such as general fireground, hazardous materials, multicasualty, and high-rise, the guide also provides a summary of ICS-US&R-120-1 in Chapter 15 in the pink pages.



# RESCUE SYSTEMS 1

## Basic Rescue Skills



### Topic 1-1: The California Urban Search and Rescue System

## **ICS-US&R 120-1: Operational System Description (OSD)**

### **January 2004 Introduction**

The US&R organizational module is designed to provide supervision and control of essential functions at incidents where technical rescue expertise and equipment are required for safe and effective rescue operations. US&R incidents can be caused by a variety of events such as an earthquake or terrorist incident that result in widespread damage to a variety of structures and entrap hundreds of people. Other examples of US&R events can range from mass transportation accidents with multiple victims to single-site events such as a trench cave-in or confined space rescue involving only one or two victims. US&R operations are unique in that specialized training and equipment are required to mitigate the incident in the safest and most efficient manner possible.

Initial Urban Search and Rescue operations will be directed by the first arriving public safety officer who will assume command as the Incident Commander (IC). Subsequent changes in the incident command structure will be based on the resource and management needs of the incident following established ICS procedures.

Additional resources may include US&R Companies and US&R Crews specifically trained and equipped for urban search and rescue operations. The US&R Company is capable of conducting search and rescue operations at incidents where technical expertise and equipment are required. US&R Crews are trained urban search and rescue personnel dispatched to the incident **without** rescue equipment. US&R Companies and Crews can be assigned as a single resource, grouped to form US&R Strike Teams, or added to other resources to form a Task Force. US&R Single Resources, Strike Teams, and Task Forces are managed the same as other incident resources.

Because of the unique hazards and complexity of urban search and rescue incidents, the IC may need to request a wide variety and amount of multidisciplinary resources.

### **Four Levels of US&R Operational Capability**

US&R Companies and Crews are “typed” based on an identified operational capability. Four levels of US&R operational capability have been identified to assist the IC in requesting appropriate resources for the incident. These levels are based on five general construction categories and an increasing capability of conducting a rescue at specified emergency situations with an identified minimum amount of training and equipment.

**The US&R Type-4 (basic) operational level** represents the minimum capability to conduct safe and effective search and rescue operations at incidents involving nonstructural entrapment in noncollapsed structures.

**The US&R Type-3 (light) operational level** represents the minimum capability to conduct safe and effective search and rescue operations at structure collapse incidents involving the collapse or failure of Light-Frame Construction and low-angle or one-person-load rope rescue.

**The US&R Type-2 (medium) operational level** represents the minimum capability to conduct safe and effective search and rescue operations at structure collapse incidents involving the collapse or failure of Heavy Wall Construction, high-angle rope rescue (not including highline systems), confined space rescue (no permit required), and trench and excavation rescue.





# RESCUE SYSTEMS 1

## Basic Rescue Skills



### Topic 1-1: The California Urban Search and Rescue System

**The US&R Type-1 (heavy) operational level** represents the minimum capability to conduct safe and effective search and rescue operations at structure collapse incidents involving the collapse or failure of heavy floor, precast concrete and steel-frame construction, high-angle rope rescue (including highline systems), confined space rescue (permit required), and mass transportation rescue.

The Regional US&R Task Force Level is composed of 29 people specially trained and equipped for large or complex Urban Search and Rescue operations. The multidisciplinary organization provides five functional elements that include Supervision, Search, Rescue, Medical, and Logistics. The Regional US&R Task Force is totally self-sufficient for the first 24 hours. Transportation and logistical support are provided by the sponsoring agency and may be supported by the requesting agency.

The State/National US&R Task Force is composed of 70 people specially trained and equipped for large or complex Urban Search and Rescue operations. The multidisciplinary organization provides seven functional elements that include Supervision, Search, Rescue, Hazmat, Medical, Logistics, and Planning. The State/National US&R Task Force is designed to be used as a single resource. However, each element of the Task Force is modularized into functional components and can be independently requested and used.

Urban Search and Rescue incidents may occur that will require rescue operations that exceed a resource's identified capability. When the magnitude or type of incident is not commensurate with a capability level, the IC will have the flexibility to conduct rescue operations in a safe and appropriate manner using existing resources within the scope of their training and equipment until adequate resources can be obtained or the incident is terminated.

### ***Minimum Training***

Each increasing level of US&R operational capability requires an increase in training. The OSD does not dictate that Rescue Systems 1 training is a requirement; however, Rescue Systems 1 does fulfill the training requirements for the Basic and Light operational levels.

### **US&R Type-4 (Basic) Operational Level**

Personnel shall be trained in hazard recognition, equipment use, and techniques required to operate safely and effectively at incidents involving nonstructural entrapment. Personnel at this level shall be competent at surface rescue that involves minimal removal of debris and building contents to extricate easily accessible victims from damaged but noncollapsed structures. Training at the basic level should at a minimum include the following:

- Size-up of existing and potential conditions and the identification of the resources necessary to conduct safe and effective urban search and rescue operations
- Process for implementing the ICS
- Procedures for the acquisition, coordination, and use of resources
- Procedures for implementing site control and scene management
- Identification, use, and proper care of personal protective equipment required for operations at structural collapse or failure incidents



# RESCUE SYSTEMS 1

## Basic Rescue Skills



### Topic 1-1: The California Urban Search and Rescue System

- Identification of five general construction categories, characteristics, and expected behavior of each category in a collapse or failure situation
- Identification of four types of collapse patterns and potential victim locations
- Recognition of the potential for secondary collapse
- Recognition of the general hazards associated with a structure collapse or failure situation and the actions necessary for the safe mitigation of those hazards
- Procedures for implementing the structure/hazard marking system
- Procedures for conducting searches at noncollapsed structures using appropriate methods for the type of building configuration
- Procedures for implementing the search marking system
- Recognition and response to the emergency signaling system
- Procedures for the extrication of easily accessible victims from nonstructural entrapments involving minimal removal of debris and building contents
- Procedures for providing disaster first aid medical care to victims
- Training to the Hazardous Materials First Responder Awareness Level (FRA)

#### US&R Type-3 (Light) Operational Level

Personnel shall meet all US&R Type-4 (Basic) level training requirements. In addition, personnel shall be trained in hazard recognition, equipment use, and techniques required to operate safely and effectively at structural collapse incidents involving the collapse or failure of light-frame construction and low-angle or one-person-load rope rescue as specified below:

- Personnel shall be trained to recognize, evaluate, and communicate the unique hazards associated with the collapse or failure of light-frame construction. Training should include but not be limited to the following:
  - Site safety, hazard assessment, and personal protective equipment required for site
  - Recognition of the building materials and structural components associated with light-frame construction
  - Recognition of unstable collapse and failure zones of light-frame construction
  - Recognition of collapse patterns and probable victim locations associated with light-frame construction
  - Procedures for implementing the emergency signaling system
- Personnel shall have an awareness of the resources and the ability to perform search operations intended to locate victims who are not readily visible and who are trapped inside and beneath debris of light-frame construction. Training should include but not be limited to the following:
  - Procedures for conducting nontechnical searches
  - Procedures for implementing the victim marking system



# RESCUE SYSTEMS 1

## Basic Rescue Skills



### Topic 1-1: The California Urban Search and Rescue System

- Capabilities and procedures for requesting US&R canine search team and technical search equipment such as video and optical visual search devices and seismic or acoustic electronic listening devices
- Personnel shall be trained in the procedures for performing access operations intended to reach victims trapped inside and beneath debris associated with light-frame construction. Training should include but not be limited to the following:
  - Lifting techniques to safely and efficiently lift structural components of walls, floors, or roofs
  - Developing and communicating a shoring plan to safely and efficiently construct temporary structures needed to stabilize and support structural components to prevent movement of walls, floors, or roofs
  - Breaching techniques to safely and efficiently create openings in structural components of walls, floors, or roofs
  - Operating appropriate tools and equipment to safely and efficiently accomplish the above tasks
- Personnel shall be trained in the procedures for performing extrication operations involving packaging, treatment, and removal of victims trapped inside and beneath debris associated with light-frame construction. Training should include but not be limited to the following:
  - Packaging victims within confined areas
  - Removing victims from elevated or below-grade areas
  - Providing medical treatment to victims at a minimum to the basic life support (BLS) level
  - Operating appropriate tools and equipment to safely and efficiently accomplish the above tasks
- Personnel shall be trained in the procedures for performing low-angle or one-person-load rope rescue involving accessing, packaging, treating, and removing victims. Training should include but not be limited to the following:
  - Rope system anchors
  - Evacuation litters
  - Rescuer and patient packaging
  - Lowering and raising systems
  - Mechanical advantage systems

#### US&R Type-2 (Medium) Operational Level

Personnel shall meet all US&R Type-3 (Light) level training requirements. In addition, personnel shall be trained in hazard recognition, equipment use, and techniques required to operate safely and effectively at structural collapse incidents involving the collapse or failure of heavy wall construction, high-angle rope rescue (not including highline systems), confined space rescue (no permit required), and trench and excavation rescue as specified below:

- Personnel shall be trained to recognize, evaluate, and communicate the unique hazards associated with the collapse or failure of heavy wall construction. Training should include but not be limited to the following:



# RESCUE SYSTEMS 1

## Basic Rescue Skills



### Topic 1-1: The California Urban Search and Rescue System

- Site safety: atmospheric monitoring, hazard assessment, and personal protective equipment required for site
  - Recognition of the building materials and structural components associated with heavy wall construction
  - Recognition of unstable collapse and failure zones of heavy wall construction
  - Recognition of collapse patterns and probable victim locations associated with heavy wall construction
- Personnel shall have a working knowledge of the resources and procedures for performing search operations intended to locate victims who are not readily visible and who are trapped inside and beneath debris of heavy wall construction.
- Personnel shall be trained in the procedures for performing access operations intended to reach victims trapped inside and beneath debris associated with heavy wall construction. Training should include but not be limited to the following:
- Lifting techniques to safely and efficiently lift structural components of walls, floors, or roofs
  - Developing and communicating a shoring plan to safely and efficiently construct temporary structures needed to stabilize and support structural components to prevent movement of walls, floors, or roofs
  - Breaching techniques to safely and efficiently create openings in structural components of walls, floors, or roofs
  - Operating appropriate tools and equipment to safely and efficiently accomplish the above tasks
- Personnel shall be trained in the procedures for performing extrication operations involving packaging, treatment, and removal of victims trapped inside and beneath debris associated with heavy wall construction. Training should include but not be limited to the following:
- Packaging victims within confined areas
  - Removing victims from elevated or below-grade areas
  - Operating appropriate tools and equipment to safely and efficiently accomplish the above tasks
- Personnel shall be trained in the procedures for performing high-angle rescue (not including highline systems) involving accessing, packaging, treating, and removing victims. Training should include but not be limited to the following:
- Rope system anchors
  - Evacuation litters
  - Rescuer and victim packaging
  - Lowering and raising systems
  - Mechanical advantage systems
  - Fall protection and/or limiter system



# RESCUE SYSTEMS 1

## Basic Rescue Skills



### Topic 1-1: The California Urban Search and Rescue System

- Personnel shall be trained in the procedures for performing confined space rescue (no permit required) operations. Training shall include but not be limited to the following:
  - Familiarity with California Code of Regulations, Title 8, Sections 5156, 5157, and 5158
  - Site safety: atmospheric monitoring, hazard recognition, and hazard assessment
  - Containing and controlling hazards within the rescue site
  - Packaging and removal of victims within confined spaces
- Personnel shall be trained in the procedures for performing trench and excavation rescue operations. Training shall include but not be limited to the following:
  - Familiarity with the California Code of Regulations, Title 8, Sections 1540, 1541, and 1541.1
  - Site safety: atmospheric monitoring, hazard recognition, and hazard assessment
  - Containing or controlling hazards within the rescue site
  - Providing a recognized “protective system” for victims and rescuers in individual trenches
  - Packaging and removal of victims from within rescue site
- Members shall be trained to the Hazardous Materials First Responder Operational Level (FRO).
- Members shall be trained in appropriate response procedures for incidents involving weapons of mass destruction (WMD).

#### US&R Type-1 (Heavy) Operational Level

Personnel shall meet all US&R Type-2 (Medium) level training requirements. In addition, personnel shall be trained in hazard recognition, equipment use, and techniques required to operate safely and effectively at structural collapse incidents involving the collapse or failure of heavy floor, precast concrete and steel-frame construction, high-angle rope rescue (including highline systems), confined space rescue (permit required), and mass transportation rescue.

- Personnel shall be trained to recognize, evaluate, and communicate the unique hazards associated with the collapse or failure of heavy floor, precast concrete, and steel-frame construction. Training should include but not be limited to the following:
  - Site safety: atmospheric monitoring, hazard assessment, and personal protective equipment required for site
  - Recognition of the building materials and structural components associated with heavy floor, precast concrete, and steel-frame construction
  - Recognition of unstable collapse and failure zones of heavy floor, precast concrete, and steel-frame construction
  - Recognition of collapse patterns and probable victim locations associated with heavy floor, precast concrete, and steel-frame construction
- Personnel shall have a working knowledge of the resources and procedures for performing search operations intended to locate victims who are not readily visible and who are trapped inside and beneath debris of heavy floor, precast concrete, and steel-frame construction.



# RESCUE SYSTEMS 1

## Basic Rescue Skills



### Topic 1-1: The California Urban Search and Rescue System

- Personnel shall be trained in the procedures for performing access operations intended to reach victims trapped inside and beneath debris associated with heavy floor, precast concrete, and steel-frame construction. Training should include but not be limited to the following:
  - Lifting techniques to safely and efficiently lift structural components of walls, floors, or roofs
  - Developing and communicating a shoring plan to safely and efficiently construct temporary structures needed to stabilize and support structural components to prevent movement of walls, floors, or roofs
  - Breaching techniques to safely and efficiently create openings in structural components of walls, floors, or roofs
  - Operating appropriate tools and equipment to safely and efficiently accomplish the above tasks
- Personnel shall be trained in the procedures for performing extrication operations involving packaging, treatment, and removal of victims trapped inside and beneath debris associated with heavy floor, precast concrete, and steel-frame construction. Training should include but not be limited to the following:
  - Packaging victims within confined areas
  - Removing victims from elevated or below-grade areas
  - Operating appropriate tools and equipment to safely and efficiently accomplish the above tasks
- Personnel shall be trained in the procedures for performing high-angle rescue (including highline systems) involving accessing, packaging, treating, and removing victims. Training should include but not be limited to the following:
  - Rope system anchors
  - Evacuation litters
  - Rescuer and victim packaging
  - Lowering and raising systems
  - Mechanical advantage systems
  - Fall protection and/or limiter system
- Personnel shall be trained in the procedures for performing confined space rescue (permit required) operations. Training shall include but not be limited to the following:
  - Site safety: atmospheric monitoring, hazard recognition, and hazard assessment in permit-required confined spaces, tunnels, or other long remote entries, high vertical access, and hazardous environmental entries
  - Containing and controlling hazards within the rescue site
  - Packaging and removal of victims within confined spaces
- Personnel shall be trained in the procedures for performing extrication operations involving packaging, treating, and removing victims trapped within mass transportation systems. Training should include but not be limited to the following:
  - Procedures to conduct a size-up of existing and potential hazards
  - Recognition of special hazards, safety systems, and construction of transportation systems
  - Packaging and removal of victims from within rescue site



# RESCUE SYSTEMS 1

## Basic Rescue Skills



### Topic 1-1: The California Urban Search and Rescue System

- Extrication techniques to safely and efficiently gain access to trapped victims
- Procedures to safely and efficiently stabilize, support, and lift different types of transportation vehicles
- Operating specialized tools and equipment to safely and efficiently accomplish the above tasks

### **Five General Construction Categories**

Identifying the general construction category of a structure that has experienced a collapse or failure will help determine the appropriate US&R operational capability required to mitigate the incident. The five general construction categories the rescuer will most likely encounter in collapse or failure situations are light-frame, heavy wall, heavy floor, precast concrete, and steel-frame. Several common structures are built using a combination of these general construction categories, such as light-frame multiunit residential structures built on top of concrete parking garages of one or more stories, reinforced with steel reinforcing bars (rebar) or post-tensioned cables and steel-frame buildings constructed on top of concrete commercial and parking structures.

### **Light-Frame Construction (Wood and Light Metal Stud)**

Structures in this general construction category are typically built with a vertical load resisting system of closely spaced wood or light-gauge metal studs for bearing walls and joists for floors and rafters for roof. The lateral resistance is provided by wall and floor sheathing, which enables these box-type structures to remain square and plumb providing a high degree of structural flexibility to applied lateral forces from earthquakes and strong winds. These buildings are configured as follows:

Roof:	Wood or metal rafters or trusses spaced 16" to 32" on center. Sheathing may be spaced or solid boards laid straight or diagonally, or plywood.
Floors:	Wood or metal joists or flat trusses spaced 12" to 24" on center. Sheathing may be wood boards laid straight or diagonally, or plywood. Floors of newer construction may have 1" or 2" concrete topping over plywood sheathing.
Exterior Walls:	Wood or metal studs spaced 16" to 24" on center. Sheathing may consist of wood boards laid straight or diagonally, or plywood. For smaller and older buildings, lath and plaster or gypsum board is used for sheathing.
Interior Columns and Walls:	Most have walls with wood or metal studs spaced 16" to 24" on center that are sheathed with any of the types listed for exterior walls. Wood lath and gypsum plaster were used in older wood buildings. Larger buildings of this type may include column and beam framing in addition to the stud-bearing walls.
Number of Stories:	These may include up to 4 stories for wood stud multiunit residential buildings and up to 6 stories for metal stud multiunit residential and mixed-use buildings.
Occupancy Types:	These may include single-family and multiunit residential buildings, plus low-rise commercial, institutional, and light industrial.



# RESCUE SYSTEMS 1

## Basic Rescue Skills



### Topic 1-1: The California Urban Search and Rescue System

#### **Heavy Wall Construction (Exterior Walls of Reinforced Masonry, Unreinforced Masonry, and Tilt-up Concrete)**

Structures in this general construction category are box-type structures typically built with heavy, fire-resistant exterior walls and lightweight wood floors and roof. The exterior walls are constructed of reinforced masonry (RM), unreinforced masonry (URM), or tilt-up concrete (TU). The adequacy of the interconnection of the walls and floors plus roof usually determines how well these structures resist the effects of earthquake forces and strong winds. State law in California requires URM structures be strengthened to reduce the collapse potential of these vulnerable walls in major earthquakes. These buildings are configured as follows:

**Roof:** URM usually has wood rafters or nailed wood trusses made from 2x, and 1x members that are sheathed with straight 1x wood sheathing. Bowstring (curved top with flat bottom) and other trusses were also used for main roof supports, with 2x joist and 1x straight sheathing. TU is usually built with panelized system with long-span glued-laminated (glulam) wood beams, 4x purlins, 2x subpurlins, and plywood sheathing or other lightweight roof systems.

**Floors:** URM usually has 2x or 3x wood joist with straight 1x wood sheathing. TU is usually built using large wood joist or flat wood trusses with plywood sheathing.

**Exterior Walls:** URM walls usually have 9"-thick parapet walls, and 4" is added to the thickness for each story in height. A typical two-story URM building will have 13"-thick walls and a 9"-thick parapet wall. TU walls are reinforced concrete, 6" or greater in thickness. They are cast flat on site in approximately 24' widths and tilted into position.

**Interior Columns and Walls:** URM may have wood stud walls. Large wood columns and beams may also be used. There may or may not be a uniform grid layout. TU usually has steel pipe/tube columns spaced in a 24' on center by 50' or similar spacing. They almost always have a uniform structural grid. Buildings with long-span trusses may have no interior columns.

**Number of Stories:** URM can be up to 8 stories high, but most are 2 stories or less. TUs are mostly 1 story, up to 24' high. Some may be 2 or 3 stories with up to 40'-high walls.

**Occupancy Types:** URM may include occupancies as in TUs as well as multifamily residential and institutional structures. TUs may include office, commercial, educational (gymnasiums), or industrial and warehouse buildings.





# RESCUE SYSTEMS 1

## Basic Rescue Skills



### Topic 1-1: The California Urban Search and Rescue System

#### Heavy Floor Construction (Cast-in-Place Concrete)

Structures in this general construction category are typically built using cast-in-place concrete (CIP) construction consisting of heavy concrete floors. Steel reinforcing bars (rebar) are most commonly used to provide the tension resistance within each concrete member, but post-tensioned steel cables may also be employed. These structures may be built using concrete beam/column frame to provide moment frame resistance or concrete shear walls to provide box-type resistance to earthquake forces and strong winds. These buildings are configured as follows:

**Roof and Floors:** These use concrete slabs with beams, concrete joist with girders, and waffle or two-way flat slab assemblies.

**Exterior Columns and Walls:** Concrete moment frame structures use reinforced concrete columns as the main exterior supports. The spaces between columns are enclosed with infill or panel walls of glass in metal frames, metal studs and plaster, brick, brick or stone veneer on metal studs, and precast concrete panels. Combinations of these materials may also be used. In older and non-West Coast buildings, infill walls may be constructed using very brittle materials such as URM and hollow clay tile. These structures are very vulnerable to earthquake damage. Box-type structures may have some concrete columns with infill walls as with concrete framed structures, but reinforced concrete shear walls are used for the main exterior walls.

**Interior Columns and Walls:** Both concrete framed and box types may have a grid of concrete columns, and interior spaces are divided using nonstructural walls constructed using metal studs and gypsum board or URM. Box-type structures often have interior concrete shear walls.

**Number of Stories:** Heights vary from single-story to high-rise structures.

**Occupancy Types:** These may include any occupancy type. Occupancies most often found are offices, schools, apartments, hospitals, hotels, parking structures, and multipurpose facilities. Highway bridges and overpasses are a special form of very heavy floor construction.



# RESCUE SYSTEMS 1

## Basic Rescue Skills



### Topic 1-1: The California Urban Search and Rescue System

#### Precast Concrete Construction

Structures in this general construction category are typically built using modular precast concrete components that include floors, walls, beams, columns, and other subcomponents that are field-connected upon placement on site. Floor and roof components are normally reinforced using pretensioned steel cables that are bonded to the concrete as it is cast around the cables in the precasting factory. Individual concrete components use imbedded steel weldments and cast-in-place topping slabs for the interconnection that provides for structural stability. These interconnections are critical, since inadequate ones have led to widespread collapse problems during past earthquakes. These structures are usually built using a regular grid of columns and beams and most often have concrete or masonry shear walls to provide box-type resistance to earthquake forces and strong winds. These buildings are configured as follows:

**Roof and Floors:** Single and double T components are used in longer span systems to span between precast beams. Hollow core or solid concrete planks are used to span shorter distances between beams or walls. Cast-in-place (rebar or post-tensioned) concrete slabs over pretensioned precast concrete girders are often used in garages and office buildings.

**Exterior Columns and Walls:** Precast concrete columns are often used as the main exterior supports. The spaces between columns may be enclosed with infill or panel walls of glass in metal frames, metal studs and plaster, reinforced masonry shear walls, brick or stone veneer on metal studs, and precast concrete panels. Combinations of these materials may also be used. Precast concrete frames, as well as cast-in-place concrete shear walls, have been used as the main exterior supports for these structures.

**Interior Columns and Walls:** A grid of precast concrete or steel columns is usually used to support the beams and girders. Interior spaces may be divided using nonstructural walls constructed using metal studs and gypsum board or concrete masonry unit (CMU) blocks. Nonstructural walls in non-West Coast types may employ URM.

**Number of Stories:** Heights vary from single-story to high-rise structures.

**Occupancy Types:** These may include commercial, office, and multiuse or multifunction structures, including parking structures and large occupancy facilities. Highway bridges and overpasses may be constructed using precast concrete segments or precast beams in combination with cast-in-place concrete slabs.



# RESCUE SYSTEMS 1

## Basic Rescue Skills



### Topic 1-1: The California Urban Search and Rescue System

#### Steel-Frame Construction

Structures in this general construction category are typically built using some type of steel beam and column system that is configured in a grid pattern. Lateral resistance against earthquake and severe wind forces is provided either by specially designed frames or diagonal bracing. These buildings are configured as follows:

**Roof:** Roof purlins and beams are composed of solid steel or light steel bar joists that are sheathed with corrugated metal deck. In all but some prefab types the sheathing is covered with insulation to form a flat surface. Purlins, beams, and bar joists are supported by steel girders or trusses. Some steel-frame structures may have wood sheathing, joists, and beams that are supported by steel girders and/or trusses.

**Floors:** Floors are normally built using concrete fill on corrugated metal deck, but, in some cases, precast concrete planks or even wood truss joists with plywood sheathing may be used. Solid steel beams and steel trusses normally are used to span between the steel girders.

**Exterior Columns and Walls:** Steel columns are the main exterior supports. The spaces between columns may be enclosed with infill/panel walls of glass in metal frames, metal studs and plaster, brick or stone veneer on metal studs, metal siding, and precast concrete panels. Combinations of these materials may also be used. In older and non-West Coast buildings, infill walls may be constructed using very brittle materials such as URM, terra cotta tiles, and hollow clay tiles.

**Interior Columns and Walls:** A grid of steel columns is usually used to support the beams and girders. Interior spaces may be divided using nonstructural walls constructed using metal studs and gypsum board. Nonstructural walls may employ URM.

**Occupancy Types:** Prefabricated metal buildings include mostly one-story, light-industrial buildings. Low-rise, nonfireproofed buildings and other structures include one- and two-story commercial, office, large industrial facilities, institutional structures, and convention and sports arenas with high, exposed roof systems. High-rise, fireproofed buildings include multistory structures configured with fire sprinklers, standpipes, smokeproof stairs, and other fire protection systems. Fireproofing may consist of sprayed-on fiber, layers of gypsum board, or, in older buildings, concrete and masonry encasement.



# RESCUE SYSTEMS 1

## Basic Rescue Skills

### Topic 1-2: Rescue Operations



## Topic 1-2: Rescue Operations

**Scope:** This chapter serves as an introduction to rescue operations.

**Terminal Learning Objective (TLO):** At the end of this chapter, the student will be familiar with a structural collapse incident that presents the rescuer with a multitude of hazards and problems and uses the four phases of structural collapse rescue. Hazards can come from the structure itself, the surrounding area, and unsafe procedures used by the rescue team. Rescuer safety must be a priority stressed before, during, and after the incident by all personnel at the incident.

**Enabling Learning Objectives (ELO):**

1. Describe the four phases of structural collapse rescue.
2. Describe the checklist for the management of a structural collapse incident.
3. Describe US&R search.
4. Describe the search marking system.

Urban search and rescue incidents come in all sizes and shapes. The mitigation of these incidents, no matter how small or large, simple or complex, requires that certain operations take place. Each incident will dictate the order in which these operations need to take place. The following information will offer guidance and insight on what should be considered and general time frames for operations to begin and end.

### **Four Phases of Structural Collapse Rescue**

#### **Phase I: Size-up, Scene Management, and Surface Victim Rescue**

Phase I starts with the occurrence of the event and can last a few minutes or several hours, depending on the magnitude of the event. Several things must occur at the same time during Phase I to ensure a smooth and orderly response.

The first and most important function is to find out how big the problem is by conducting a size-up of the incident. This is done by sending out reconnaissance (recon) teams to assess the overall damage. Size-up can be as simple as an organized walk around an involved structure or as complicated as involving recon of the entire community. Quite often the size-up function is not performed because the tendency in a disaster situation is to help the first victims or fix the first problems encountered. By doing this, larger groups of victims and problems that are more serious may go unreported for many minutes or even hours. Emergency service providers should not stop at the first victims or problems encountered unless the situation can be quickly resolved so the size-up process will continue.

A good size-up will tell those in command if they can handle the situation with available resources or if they are going to have to call in additional resources and mutual aid. It will tell them what kinds of additional resources are going to be needed and the hazards that need to be dealt with.

While size-up is occurring, it is essential to establish an Incident Command System (ICS). Once the IC is in place and information is flowing about the nature of the problem, additional resources can be requested as needed. A staging area for the requested resources and a location for the treatment of injured victims should be established. Activate and staff the local Emergency Operations Center (EOC), if needed. An

Incident Action Plan (IAP) and a backup plan should be formulated by the IC or the EOC command staff at incidents involving a large portion of the community.

Simultaneously, along with size-up and scene management, surface victim rescue occurs. Surface victims are often defined as victims who are injured but not trapped. Surface victims are usually injured in falls or are struck by falling objects, are located outside and inside noncollapsed buildings, and account for approximately 50 percent of the victims at a structural collapse incident. Most surface victims are rescued by spontaneous rescue teams consisting of family, friends, coworkers, or passersby before the arrival of organized rescue personnel. They are usually removed easily from further danger, provided basic first aid, or transported to advanced medical care, if needed.

Some organizations prefer to split Phase I into two phases. However, because size-up and scene management activities usually occur at the same time or before the rapid rescue of surface victims, they are grouped together here as a Phase I. Concentrating on surface victim rescue in Phase I of an incident will do the most good for the most people, in the shortest amount of time with limited resources.

## Phase II: Search All Accessible Areas and Void Spaces

Phase II takes place after organized rescue teams arrive and after an ICS is established. Rescue teams use the information gathered during the size-up and reconnaissance to start searching the most likely spots where victims could be trapped inside noncollapsed and collapsed buildings. The most likely areas to search first should be based on verbal reports from survivors or witnesses, building use, and time of day.

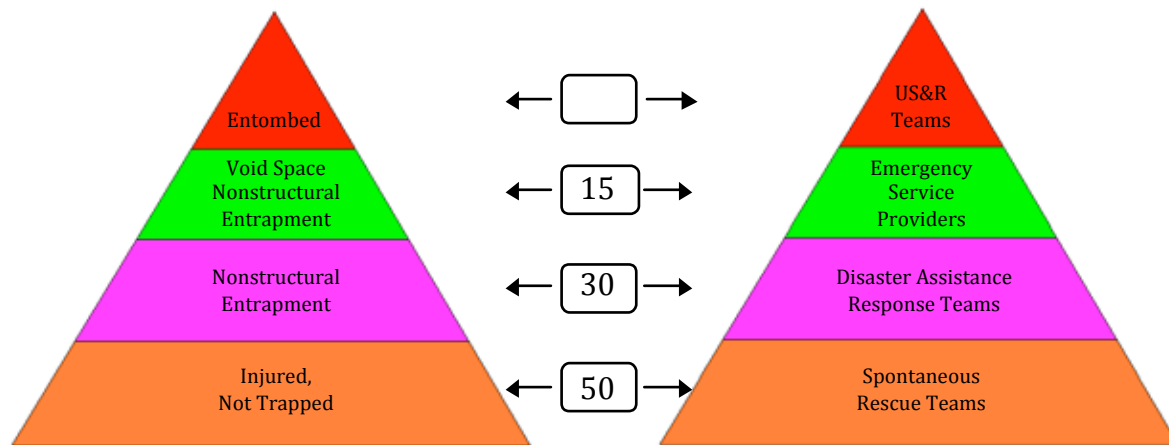


Figure 1:1 Structural Collapse Victim to Rescue Skills Needed Ratio

Methods of locating people who are lightly trapped inside a collapsed building might include a physical search, voice “call out” hailing system, trained Urban Search and Rescue dog teams, and specialized listening and looking devices.



# RESCUE SYSTEMS 1

## Basic Rescue Skills

### Topic 1-2: Rescue Operations



Approximately 30 percent of the victims at a structural collapse incident are “lightly” trapped in accessible areas inside noncollapsed buildings. Victims are usually trapped by building contents like file cabinets, bookshelves, refrigerators, machinery, and small pieces of debris rather than by the structure itself.

Approximately 15 percent of the victims at a structural collapse incident are trapped inside accessible void spaces created by the collapsed structure. Victims may also be trapped by building contents inside accessible void spaces created by the collapsed structure. A highly trained and equipped rescue team of up to ten people can take an average of four hours to extricate a victim trapped in an accessible void space.

### **Phase III: Selected Debris Removal**

Phase I and II will produce the majority of victims that can be rescued in a timely manner. Approximately 5 percent of the victims at a structural collapse incident are entombed or trapped by primary structural components such as walls, floors, columns, support beams, and roofs. A highly trained and equipped rescue team of up to ten people can take an average of ten hours to extricate a victim entombed or trapped by primary structural components.

Selected debris removal is a very hazardous situation. The cost-to-benefit ratio (danger to rescuers vs. live victim rescue) must be evaluated. The following operational procedures should be considered:

1. Remove all rescue personnel from the structure and mitigate all possible hazards.
2. Develop a systematic plan for removing the selected portions of debris based on advice from an on-site structural engineer and the highest probability of finding live victims.
3. Maintain at all times constant coordination and communications with all heavy equipment and rescue team members.
4. If possible, remove the debris from the top toward the bottom.
5. Mark newly created debris piles to prevent future rescue teams from searching the rubble just moved.
6. Limit the number of rescue team members inside and near the structure to a minimum.
7. Develop a contingency plan for live or deceased victims found.

### **Phase IV: General Debris Removal**

Phase IV occurs when the possibility of finding any live victims is highly unlikely due to the victim count, duration of the incident, or other factors such as weather extremes or cause of the collapse. The structure and debris are systematically removed with heavy equipment without regard or preference to any particular location. Develop a contingency plan for the remote possibility of a live victim being found. Rubble removed from the structure must be inspected for bodies and body parts. Any bodies or body parts found must be handled in a predetermined manner coordinated with local law enforcement and coroner officials.



# RESCUE SYSTEMS 1

## Basic Rescue Skills

### Topic 1-2: Rescue Operations



### **Checklist for the Management of a Structural Collapse Incident**

1. Complete all aspects of Phase 1 of structural collapse rescue: size-up, scene management, and surface victim rescue.
2. Identify and request additional resources:
  - Local and mutual aid resources
  - Specialized resources such as structural engineers, US&R search dogs, or US&R technical specialists
  - Specialized equipment such as cranes, front-loaders, and dump trucks
3. Control site perimeter and spontaneous rescuers or convergent volunteers.
4. Secure all utilities.
5. Deploy fire protection hoselines, if necessary, for the type of structure and present conditions.
6. Request support resources such as American Red Cross, Salvation Army, utility companies.
7. Establish priorities; develop and implement plans with organized resources to accomplish the remaining phases of structural collapse rescue.
8. Complete Phase II: search all accessible areas and void spaces.
9. Complete Phase III: remove selected debris.
10. Complete Phase IV: remove general debris.

### **US&R Search**

Within the four phases of structural collapse, search needs specific attention. In any US&R incident, if you are unable to find anyone in need of help in a timely and efficient manner, the rescue disciplines you learn in Rescue Systems 1 are all for naught.

In order for any rescue to be successful, the victims must be located. The rescue is dependent upon the completion of a thorough and successful search operation. Basic search techniques allow the rescuer to determine the location of victims and identify means of access to those victims in order to remove them to a safe area. A search operation must be well organized and use the tools available to the on-scene personnel. These tools may be as basic as an organized physical search performed by on-scene personnel or a more technical search using specially trained dogs or sophisticated electronic devices.

Additionally, the findings of the search effort must be clearly communicated. Methods to communicate this information include basic verbal communication through the chain of command as well as an organized and consistent marking system that should be placed on the actual structure during multisite operations.

### **Gather Information to Locate Victims**

The information-gathering process to locate victims begins before the event occurs. Knowledge of the specific structure and the type of occupancy helps determine the number and locations of victims. Size-up and recon begin organized information gathering specific to the event.



# RESCUE SYSTEMS 1

## Basic Rescue Skills

### Topic 1-2: Rescue Operations



Relevant information must be gathered to help in organizing the search process. The type of occupancy (hospital, school, or factory) provides valuable information regarding the expected number of occupants. Construction materials and the building layout will affect the way the building will behave following a significant event. This information can be further quantified by the time of day and the day of the week. A school would not be expected to be fully occupied if the incident occurred after normal school hours or on the weekend.

Before and during the search, rescuers should identify the type of collapse patterns that have occurred. This will assist in locating probable victim survival areas within the structure. Keep in mind the characteristics of the four types of collapse patterns as they relate to the potential void spaces created and proper stabilization techniques. Hazards to victims and rescuers should be identified, removed, or mitigated before and during the entire search and rescue operation.

Search personnel should also consider other potential victim locations within the structure. These include areas least likely to collapse, such as stairwells, hallways, and elevator shafts. Underground parking garages and basements are also safe areas where victims may survive but not be able to escape.

A good source for relevant information available before the incident is the Pre-Incident Site Plan. Additional information is also acquired during size-up and recon. Verbal reports from survivors, coworkers, eyewitnesses, and relatives can provide knowledge about the victim's last known location. Contractors and building engineers who were involved in building construction or maintenance may provide valuable information regarding potential victim locations, building layout, and access. These personnel may also have building plans that could be invaluable during recon as well as the search process.

### **Types of Search**

The hasty search (primary search) and the extensive/grid search (secondary search) are the two search types. The hasty search provides rapid detection of potential victims, assists in the size-up of the rescue problem, and helps determine priorities. The extensive/grid search involves a thorough systematic search, redundant checks, and verification with alternate search resources and confirms exact location of victims.

### **Search Categories**

The three main search categories are physical search, US&R canine search, and technical search. Both the US&R canine search and technical search require specific resources and a significant commitment to training. Each search category has advantages and disadvantages. Usually no single resource or tactic is sufficiently effective on its own. The most effective search strategy should blend all available resources into a logical sequence.

### ***Physical Search***

Physical search involves the deployment of personnel to systematically conduct an actual search of all the accessible areas and void spaces. The physical search process is usually accomplished with readily available resources capable of quickly covering large areas and does not require search specialists or unique electronic equipment. Volunteers can be quickly trained to support the effort. Visual sighting provides conclusive verification of the exact location, position, and condition of found victims and positive findings do not require secondary verification.



Generally, only surface and readily accessible victims will be located and this tactic is most effective during daylight hours. Other limitations of the physical search are that it requires rescuers to work in close proximity to potential danger areas and those rescuers cannot access all voids in the building.

This organized approach to victim location ideally should involve personnel with backgrounds in several areas. First, safety personnel familiar with potential structural collapse hazards should be included. If available, a structural engineer, preferably familiar with collapse situations, and personnel familiar with the specific structure to be searched should be part of the Search Team.

## Hailing System

The hailing system is a technique often used in conjunction with physical search, canine search, and technical search tactics. Search personnel are placed in calling and listening positions as close as possible around the site to be searched. Spacing between search personnel is approximately 25' to 50' apart in safe locations. The team leader signals for silence and all work in the area to stop. In a clockwise rotation, each searcher calls out loudly or with a megaphone stating, "If you can hear me, call out for help or tap five times on part of the structure." At the same time as the call out, searchers may also tap five times on part of the structure or debris pile in an effort to elicit a response. All search personnel are to listen and attempt to get a "fix" on any sound heard. All search personnel are to point in the direction of any sound heard. If more than one searcher hears the sound, the direction they are pointing will triangulate on the location from which the sound is emanating. Any sound heard should be verified with at least one additional fix from another angle or location.

The hailing system technique can be accomplished with readily available resources capable of quickly covering large areas and does not require search specialists or unique electronic equipment. Volunteers can be quickly trained to support the effort that may triangulate a victim location day or night from relatively safe positions. The effectiveness of the hailing system diminishes over time as victims' conditions deteriorate. Victims must be capable of making recognizable sounds where ambient site noise is intrusive. Additional search tactics may be required to pinpoint the exact location of a victim and it may not be conclusive from this tactic that all victims have been located.

1. Place searchers in calling and listening positions around the search area (25' to 50' apart).
2. Team leader calls for silence and all work in the area to stop.
3. Team leader directs potential victims to call for help and tap on part of the structure 5 times.
4. All searchers listen and try to get a "fix" on any sound they may hear.
5. Any sound heard should be verified with at least one additional "fix" from another person at a different angle.

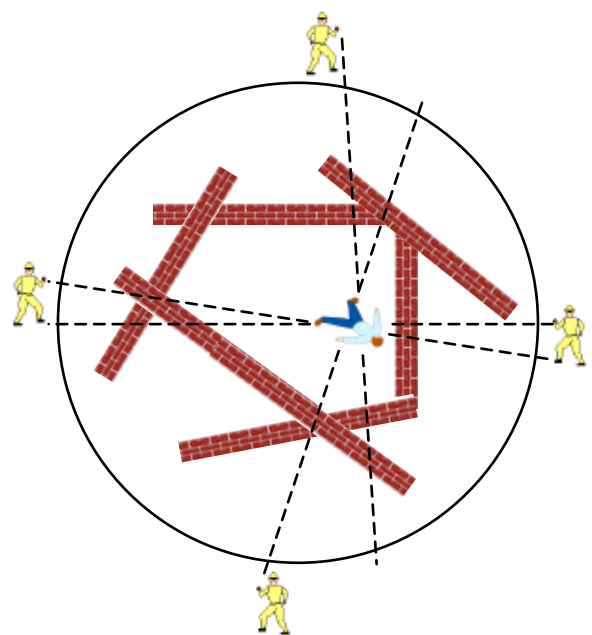


Figure 1:2 Hailing System Search

The procedure for conducting a physical search should begin with organizing the search personnel. A team leader must be identified and communication established with the IC. Search personnel should be reminded to use the buddy system, with a minimum of two persons per Search Team. If available, use an existing site plan or draw the structure layout to keep track of where you have been, where you need to go, and any hazards or victims located during the search. Search the area around the structure first. Walk around the site to identify and remove any surface victims found. At the same time, document and inform the IC of the location of any heavily entrapped victims who cannot be readily accessed or rescued.

During the walk around and after entering the structure, use the hailing system when appropriate. Enter the structure only if it is safe to do so. Address structural stability and hazard concerns before entry. Initiate the search marking system before entering the structure.

Search all the accessible rooms and areas inside the structure in an organized manner. Areas should not be skipped except for safety reasons, and any area skipped should be documented on the site plan. To search smaller individual rooms or areas, use the “go right – stay right” search method: A minimum of two Search Team members enter the structure, keeping in visual or physical contact with the wall on their right while searching in and under all possible entrapment or hiding places of each room or area. Using the same door to enter and exit each room or area ensures that they will not miss any room or area. By turning around and reversing the process, the Search Team members will always be able to find their way out of the structure.

The line search method should be used to search large rooms or areas: Search team members spread out in a straight line and slowly walk the entire width and length of the room or area being searched. The main body of the Search Team waits for other team members searching inside individual rooms or areas with the “go right – stay right” search method, which takes more time to complete.

1. Search Team in a straight line remains in visual contact.
2. Search Team waits for individual room search Team members.

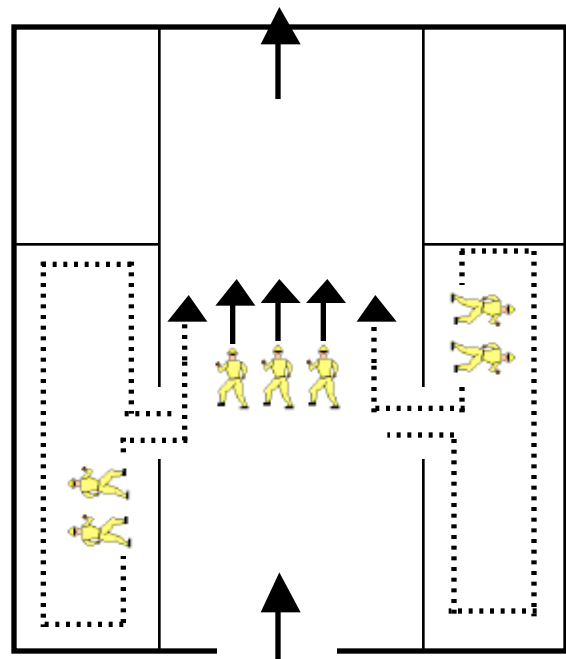


Figure 1:3 Line Search Method

During the search operation, use the victim location marking system to identify any potential victim locations or confirmed victims that are not readily visible.

Search debris piles, using caution when moving materials. Unorganized movement of rubble may cause the debris pile to shift or additional failure of the structure. Mark debris piles that have been searched or have been moved from one location to another to prevent unnecessary searching or debris movement by other personnel.

1. Buddy System: Minimum of two persons per Search Team.
2. Enter and leave the structure using the same door.

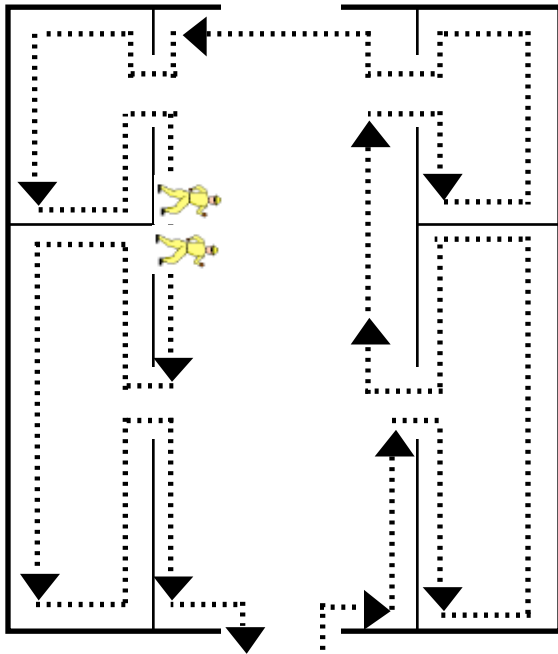


Figure 1:4 Go Right/Stay Right Search

All victims contacted must be encouraged not to give up; if possible, contact should be maintained until they are rescued. Explain the situation to the victim and, at the same time, evaluate the victim's position, entrapment, and medical condition. This information may assist in determining the best extrication approach. Also, question the victim about other known occupants of the structure. If safe to do so, leave two Search Team members with an entrapped victim to monitor the victim's condition, provide encouragement, and direct rescuers to the exact location. Continue to search if assigned to the search function. The entire structure must be completely searched in order to locate all possible victims and identify potential hazards. Stopping the search function to perform a time-consuming rescue as soon as a victim is located can prevent the discovery of more easily accessible victims or the identification of significant hazards. The site should be continually searched until all potential victims are located or accounted for.

Previously unidentified victims may be found after walls and floors are breached or debris removed. Report all findings to the IC. Information should include the location of the Search Team when finished with an area, location of any victim with a description of victim condition, entrapment and hazards, and any access information for the rescuers.

## ***US&R Canine Search***

A US&R canine search is accomplished with a trained and certified US&R canine and handler team. A second US&R canine/handler team is often used to verify a potential victim location. Extreme caution should be used if attempting to use dogs and handlers with other types of training. Canines trained in police service, drug detection, and wilderness search lack specific experience and training for this type of work. Possible harm to the victims and the canine/handler team may occur without extensive experience and training working in and around structural debris and rubble.

The US&R canine search can cover large areas in a relatively short period of time. This tactic can be used for both hasty and extensive/grid search operations. Many US&R canines can differentiate between live or dead victims buried deep within a collapsed structure or debris pile.

Canines can work "off lead" from the handler in unsafe areas, traverse debris, and gain access to voids. Trained and certified US&R canine/handler teams are a limited resource with more being trained and certified each year. Team performance may vary according to individual handler or canine capabilities, health, and temperament. Continuous refresher training is required to maintain an acceptable level of performance. The duration of the operation will be affected by weather and the physical condition of the canine. Aromatic contaminants such as marking paints, gasoline-powered tools, and other searchers will



# RESCUE SYSTEMS 1

## Basic Rescue Skills

### Topic 1-2: Rescue Operations



compromise the effectiveness of the canine search. The optimum working conditions are cool to mild temperatures, moderate to high humidity, and a light steady breeze. Most canines will require frequent work/rest breaks, usually alternating in 20- to 30-minute time blocks. Additional search tactics may be required to pinpoint the exact location of a victim.

### ***Technical Search***

The three types of technical search resources include electronic listening devices, visual search devices, and other electronic search devices. Each technical search device requires trained operators and specialized equipment costing from a few hundred to several thousand dollars.

**Electronic listening devices** can detect sounds made by conscious victims buried deep within a collapsed structure or debris pile. They are able to cover large areas and may triangulate on a victim's location with a range of 5' to 25' acoustic (voice) and 50' to 150' seismic (vibrations). The effective range of these devices is greatly affected by the type and congruency of debris. Most of the devices have two-way sound capability to communicate with the victim and some have paper readouts for comparative analysis and documentation. Some have computer interface for filtering ambient noise and matching sounds. Electronic listening devices may be used to verify other search tactics. Less sophisticated acoustic devices with public works agencies may be used for leak detection.

The usefulness of electronic listening devices diminishes over time as the victim's condition deteriorates and how well ambient site noise and vibrations can be controlled. These devices are best used at well-controlled sites or at night and early morning when ambient noise is reduced. Some of these devices require a skilled technician and up to four assistants. Duration of the operation is limited by battery constraints. This type of device should be used in conjunction with the hailing system and may require additional search tactics to pinpoint the exact location of the victim. It may not be conclusive from this search tactic that all victims have been located.

The two primary categories of **visual search devices** are "video" where images are transmitted to a TV screen and "optical" where the image is viewed directly through fiber-optic bundles or mirrors to a monocular eyepiece. Both categories provide conclusive verification of the exact location and general position and condition of the victim. Some devices can be used through openings as small as 1/4" and can extend as far as 10'. Some devices have two-way communication, provide their own light source, and are flexible enough to be positioned into tight, awkward areas. These devices require a skilled operator and the duration of operation is limited by battery constraints. Field of view, depth of view, and light intensity may be limiting factors. The search area is limited to safe accessibility and reach of the device and the results do not indicate a complete search of the site. Less sophisticated visual devices can usually be acquired from below-grade contractors, utility companies, and public works agencies.

**Other electronic search devices** include:

- Thermal sensing devices that are capable of locating thermal differences or "hot spots" in darkness or smoke. These devices cannot "see through walls," light debris, multiple layers of clothing, or heavy dust to locate victims.
- Infrared and ultraviolet sensing devices that are capable of seeing light radiation either just below or just above the visible light spectrum, producing a monochrome picture. These devices are often used to conduct covert surveillance, but have not proven to be very effective in US&R situations.



# RESCUE SYSTEMS 1

## Basic Rescue Skills

### Topic 1-2: Rescue Operations



- Electromagnetic (EM) wave detection (radar) that is capable of detecting both heartbeat and respirations through as much as 10' of concrete and steel debris. Some of these devices are expected to become smaller and less expensive in the future and may become a viable resource.

Completion of the initial search provides information to allow an organized and logical approach to safe victim rescue. Information gathered and documented during the search reported to the IC should include Search Team status, victim location, structural condition, and hazards. Continuation of the search function with as many available resources and techniques until all the victims are located or accounted for must be part of the ongoing incident process.

### **Search Marking System**

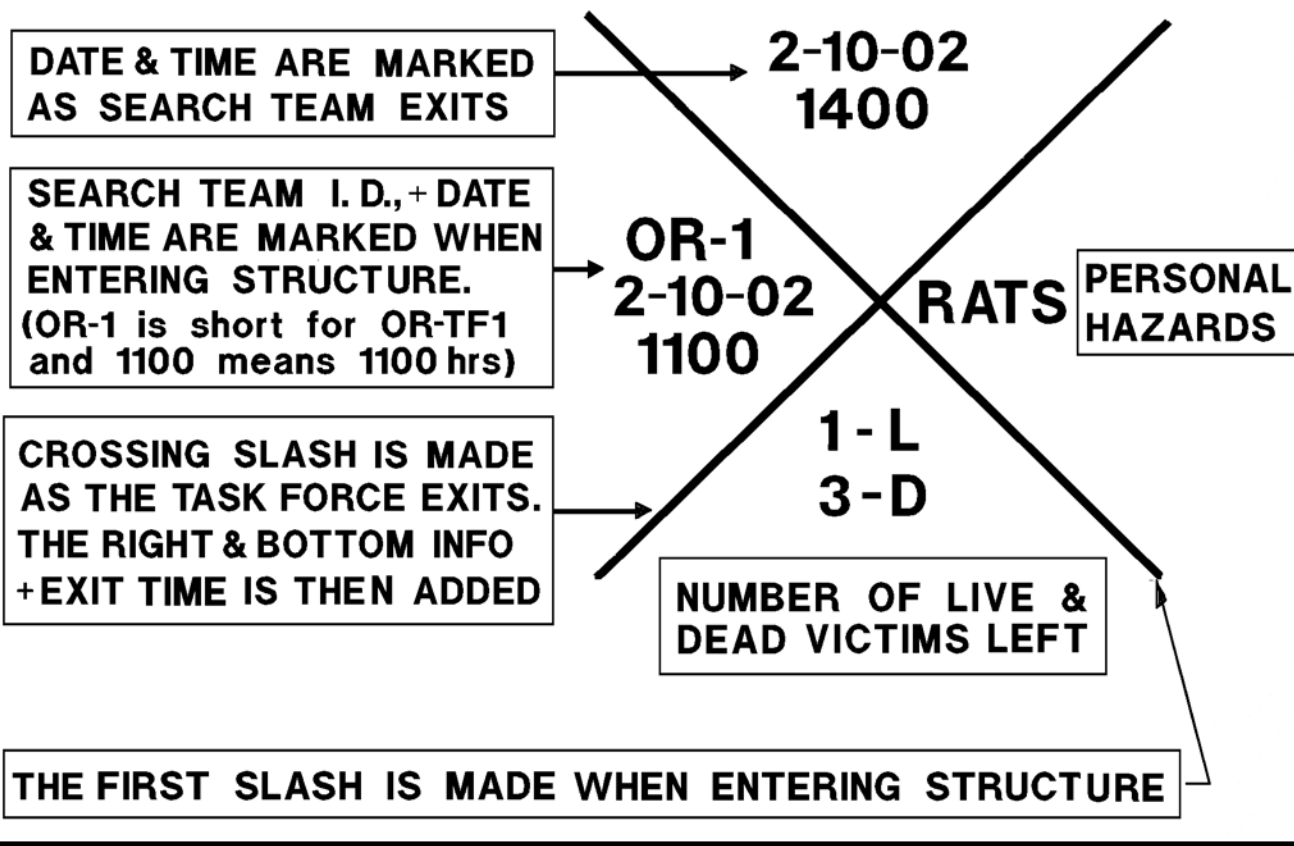
Search markings must be easy to read, easy to understand and most important, consistent throughout the Urban Search and Rescue response system. This can be accomplished by the use of a standard marking system developed by Army Corps of Engineers Urban Search and Rescue Program. This marking system is recognized as a national standard and is used by state and federal resources including the Federal Emergency Management Agency (FEMA) Urban Search and Rescue Program.

### **FEMA US&R Building Marking System**

- First, when search and rescue personnel enter the building or parts of the building, the initial diagonal line is drawn so that others will be informed of On-going Operations. The marking shall include the responding agency/search team identification, entry time, and date in the left quadrant. The time, date, and identification information will inform others as well as providing critical data should there be a question regarding personnel safety in the event of a secondary incident.
- Upon entering, the searcher(s) should proceed to the right and always keep to the right in every room in the structure.
- When operations are completed in the building (or parts of the building), the crossing diagonal line will be drawn. At the main entry, the information in the remaining three quadrants is added to indicate date and time of exit and what was found and accomplished. This will also indicate that all personnel have exited safely.
- The finished mark can then indicate to other search and rescue personnel the outcome of previous search operations.

## FEMA US&R BUILDING MARKING SYSTEM MAIN ENTRANCE SEARCH MARKING

UHR-4B  
02/05



## Main Entrance Search Marking – When You Enter

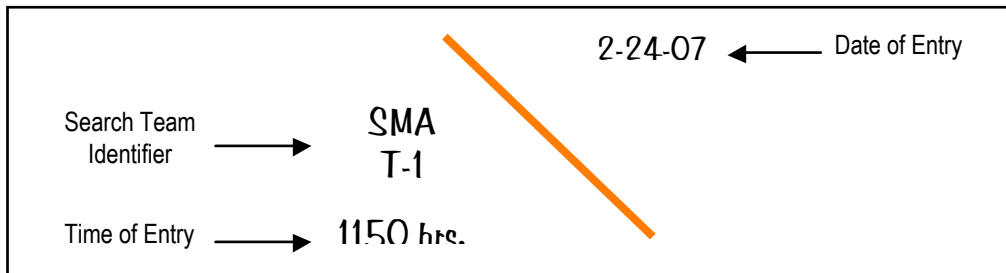


Figure 1:5

## Main Entrance Search Marking – When You Exit

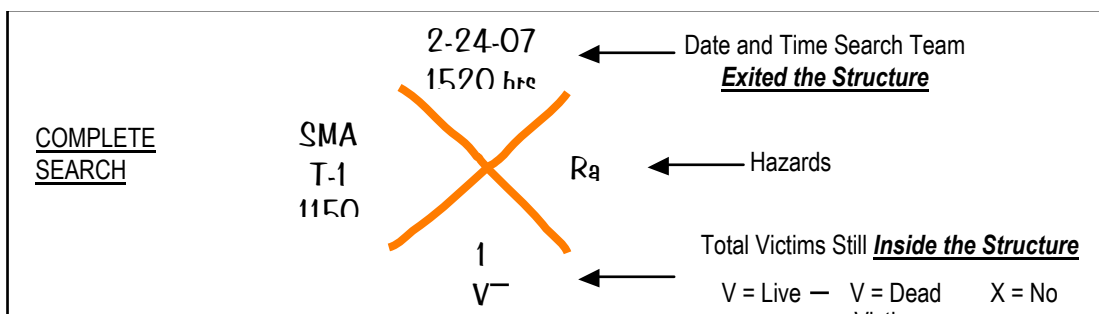


Figure 1:6

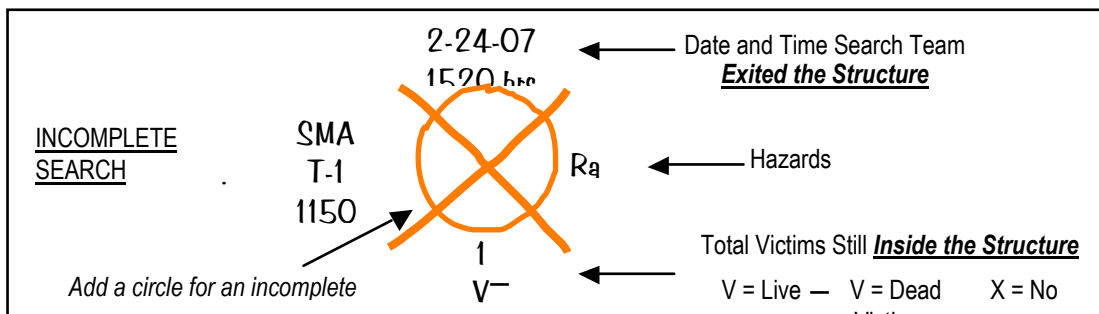


Figure 1:7

## Interior Search Markings – Each Room, Area, or Floor

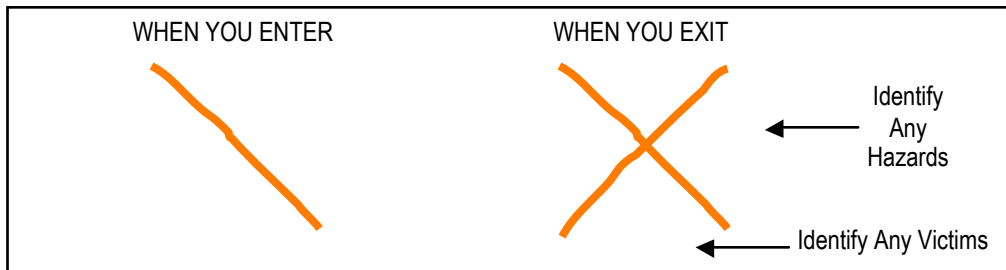


Figure 1:8

## *Victim Location Marking System*

During the search function, it may be necessary to identify the location of a known or potential victim. The amount and type of debris in the area may completely cover or obstruct the location of the known or potential victim. The victim location marking symbols are made by the Search Team or other individuals conducting search and rescue operations whenever a known or potential victim is located and not immediately removed. The victim location marking symbols should be made with orange spray paint with a line marking or “downward” application spray can.

Make a large “V” (2' x 2') with orange spray paint near the location of a **potential** victim. Mark the name of the Search Team or Crew identifier in the top part of the “V” with paint or lumber chalk or crayon.

Paint a circle around the “V” when a potential victim is **confirmed** to be **alive** either visually, vocally, or hearing specific sounds that would indicate a high probability of a live victim. If more than one confirmed live victim, mark the total number of victims under the “V”.

Paint a horizontal line through the middle of the “V” when a **confirmed** victim is determined to be **deceased**. If more than one confirmed deceased victim, mark the total number of victims under the “V”. Use both the live and deceased victim-marking symbols when combinations of live and deceased victims are determined to be in the same location.

Paint an “X” through the confirmed victim symbol after **all** victims have been removed from the specific location identified by the marking.

An arrow may need to be painted next to the “V” pointing toward the victim when the victim’s location is not immediately near where the “V” is painted.

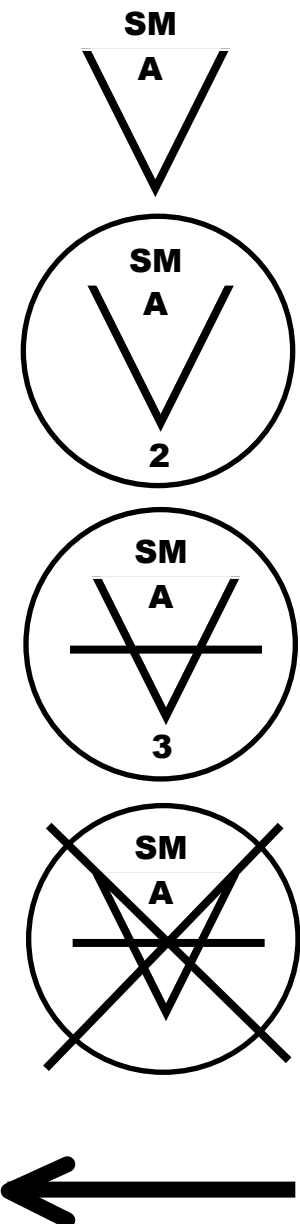


Figure 1:9



The victim location marking symbols and number of victims, if known, must be placed on the developing site map during the search of the structure or area.

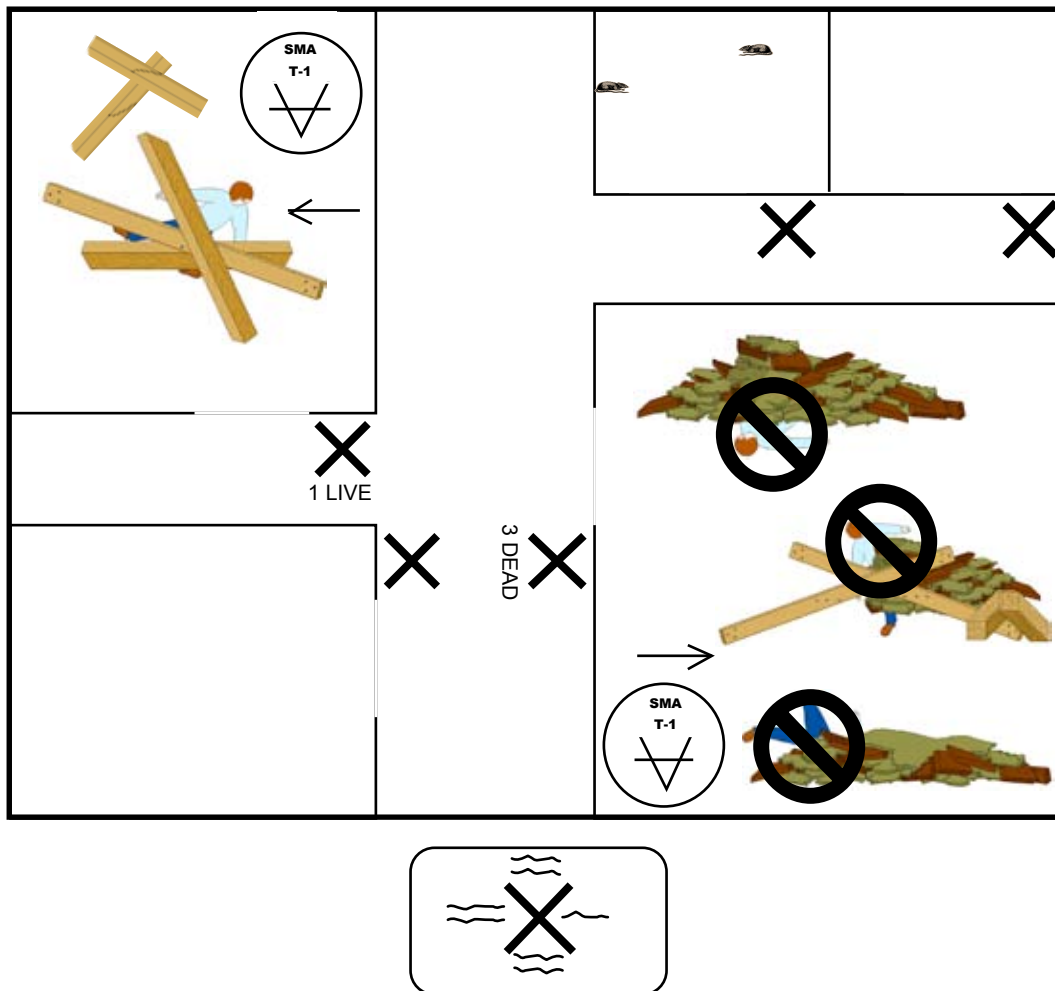


Figure 1:10 Location Marking Symbols and Number of Victims

## ***Structure/Hazards Marking System***

The identity and location of individual structures is crucial at incidents involving several structures or large areas of damage. The use of existing street names and addresses should always be considered first. If this is not possible because of damage, use the existing hundred block and place all even numbers on one side of the street and all odd numbers on the other side. Mark the new numbers on the front of the structure with orange spray paint. If the name of the street is not identifiable because of damage, start with the letter “A” using the phonetic alphabet “Alpha,” “Bravo,” “Charlie,” etc.

Structure hazards identified during initial size-up activities and throughout the incident should be noted. This structure/hazards mark should be made on the outside of all normal entry points. Orange spray paint seems to be the most easily seen color on most backgrounds and line marking or downward spray cans apply the best paint marks. Lumber chalk or lumber crayons should be used to mark additional information inside the search mark itself because they are easier to write with than spray paint.

A large square box (approximately 2' in diameter) should be outlined at any entrance accessible for entry into any compromised structure. Use orange paint for this marking. Specific markings will be clearly made adjacent to the box to indicate the condition of the structure and any hazards found at the time of this assessment. Normally, the square box marking would be made immediately adjacent to the entry point identified as safe. An arrow will be placed next to the box indicating the direction of the safe entrance if the structure/hazards marking must be made somewhat remote from the safe entrance.

## Structure/Hazards Markings

Make a large square box (2' x 2') with orange spray paint on the outside of the main entrance to the structure. Put the date, time, hazardous material conditions, and team or company identifier outside the box on the right-hand side. This information should be made with lumber crayon or chalk.

This box signifies the structure is accessible and safe for search and rescue operations. Damage is minor with little danger of further collapse.

This box signifies the structure is significantly damaged. Some areas are relatively safe, but other areas may need shoring, bracing, or removal of falling and collapse hazards.

This structure is not safe for search or rescue operations. It may be subject to sudden additional collapse. Remote search ops may proceed at significant risk. If rescue ops are undertaken, safe haven areas and rapid evacuation routes should be created.

An arrow located next to a marking box indicates the direction to a safe entrance into the structure should the marking box need to be made remote from the indicated entrance.

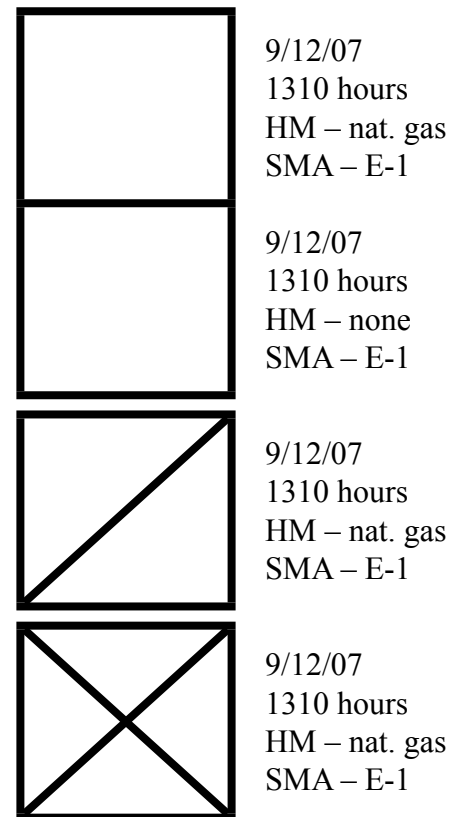


Figure 1:11



---

# RESCUE SYSTEMS 1

## Basic Rescue Skills

---





# RESCUE SYSTEMS 1

## Basic Rescue Skills



### Topic 1-3: US&R Safety and Medical Care for Victims

## Topic 1-3: US&R Safety and Medical Care for Victims

**Scope:** This chapter serves as an introduction to US&R Safety and Medical Care for Victims.

**Terminal Learning Objective (TLO):** At the end of this chapter, the student will be familiar with a structural collapse incident that can cause multiple victim injuries in a variety of ways and locations. Using some basic medical care and safety procedures during the rescue operations will greatly assist in providing the most victims with best possible chance for recovery.

**Enabling Learning Objectives (ELO):**

1. Describe the general hazards of a structural collapse.
2. Describe four general types of building construction hazards.
3. Describe four types of collapse patterns.
4. Describe the necessary personal protective equipment to use during an incident.
5. Identify the safety and medical considerations to take during an incident.
6. Describe the injuries associated with a structural collapse.
7. Describe basic infectious disease precautions to take during an incident.

Structural collapse operations cover a wide range of incident scenarios. These incidents can be as relatively minor as a deck or porch collapse resulting in easily accessible victims or as heavily taxing as a multistory concrete building collapse that entombs hundreds of victims. Regardless of the collapse scenario encountered, first-responders must be familiar with a variety of safety hazards and associated issues. Effective rescue operations at a structural collapse will be possible only if rescuers are fully aware of the hazards involved and the methods necessary to mitigate those hazards.

In order for rescuers to perform at an optimum level of safety, they must be familiar with:

- Categories of hazards; building construction types and characteristics
- Types of collapse voids and likely areas of survivability
- Safety equipment
- Safety procedures
- Safety considerations

Understanding and properly applying these factors is essential if rescuers are to perform rescue operations safely in a structural collapse.

### **Structural Collapse General Hazards**

#### **Structural Instability**

The aftermath of a building collapse will present a variety of structural instability hazards for rescuers. These might include weakened walls, floors, columns, or beams that are incapable of supporting the remains of the structure. Secondary collapse of structural elements will be a major concern to rescuers working in areas supported by these weakened building parts.



# RESCUE SYSTEMS 1

## Basic Rescue Skills



### Topic 1-3: US&R Safety and Medical Care for Victims

Freestanding walls and damaged or loose chimneys can easily fall because of a lack of support, wind load, or earthquake aftershocks. In earthquake-prone areas, collapses resulting from quakes will be highly vulnerable to further collapse because of aftershocks.

Normal settlement and shifting debris, vibrations, and aftershocks can cause secondary collapse and previously accessible voids to become inaccessible or can eliminate the void spaces altogether. Secondary collapse may cause currently undamaged attached or exposed structures in close proximity to fail.

Very often, structural stability is difficult to evaluate and requires the services of a structural engineer. Responders are encouraged to contact structural engineers in their response areas to determine their availability if needed.

### **Overhead Hazards**

Rescuers performing operations at a collapse site must evaluate the scene for overhead hazards that have the potential to fall and strike rescuers. Overhead hazards may include loose debris and building components suspended overhead, sections of concrete hanging from attached reinforcing bars, or dislodged bricks precariously perched on a broken wall assembly. Unsecured building contents such as file cabinets, bathtubs, refrigerators, and other furnishings can also create overhead hazards should they fall out of the structure.

Damaged electrical wires hanging low or heavily tensioned and ready to fail may pose an electrocution danger or choking and entanglement hazard.

Scaffolding and stacked building supplies, such as piles of drywall perched on an upper floor of a building under construction, are overhead hazards common to construction site collapses. Rescuers must take the necessary time to evaluate their surroundings and to identify these potential hazards before committing resources to a dangerous area.

Rescue operations that are being performed also can create overhead hazards from crews working above each other and the sudden failure of rigging chains or slings that are damaged or overloaded during a crane lifting operation. This may cause massive building components to be dropped on rescuers working in close proximity to where the lift is being performed. For this reason all rescuers must be informed when heavy equipment will be used for performing rescue operations. All rescuers also must clear the area when a load is being lifted overhead.

### **Surface Hazards**

The environment within which rescuers must operate at a building collapse will be full of sharp debris that can cause injury. This debris will differ depending on the building's construction and contents. Generally, rescuers will be faced with broken glass, nails, wood splinters, jagged metal, and rough masonry. Difficult footing will be common due to spilled fluids and pools of water and sewage. Ground fissures, depressions, and uneven or unsecured walking surfaces around the collapse site will add to difficult footing that can potentially result in injuries to responding personnel.

Water and other liquids on the ground will obscure the view of the walking surface and reduce friction; they can lead to potential electrocution if contacting an energized power source and drowning if the water is deep enough to cover the rescuer's face. Liquids will also cause hypothermia problems for rescuers



# RESCUE SYSTEMS 1

## Basic Rescue Skills



### Topic 1-3: US&R Safety and Medical Care for Victims

and victims, add additional weight to structural elements and debris, and soften the ground supporting structural elements and debris.

Rescuers must be aware of the potential for downed or exposed live electrical wires. All wires and conduits must be considered live until confirmed otherwise.

Heavy equipment vibrations can cause debris to shift and lead to secondary collapse. Engine noise can drown out communication and other sounds that could warn rescuers of changing conditions; operators with an obstructed view while backing or turning could run into damaged structures and over rescuers; and a secondary collapse can be caused by lifting, pulling, or removing structural components with powerful heavy equipment unable to feel the structure shifting.

Additional potential surface hazards include open manholes resulting from flooding or ground-level openings created by the force of the collapse. Fallen trees and utility poles blocking roadways may cause access problems for responding apparatus and personnel.

#### **Below-Grade Hazards**

These hazards will occur in areas such as basements, underground parking garages, or low-lying void spaces. The potential exists in these areas for the accumulation of atmospheric hazards due to ruptured natural gas lines or spilled chemicals. Contaminated atmospheres can be flammable, toxic, or oxygen deficient. Flooding from broken water or sewer lines may also cause difficulties for rescuers by obscuring the view of the walking surface and reducing friction; other hazards include electrocution if contacting an energized power source, drowning if the water is deep enough to cover the rescuer's face, and contamination from raw sewage and other chemicals mixing with liquids.

#### **Utility Hazards**

The most common utility types include natural gas, propane, electricity, steam, water, and sewage. When these utilities are disrupted because of a collapse, they will cause serious safety hazards for rescuers. These will include electrocution and fire hazards from broken electrical wiring and explosion hazards from broken natural gas and heating fuel lines. Disrupted steam lines can cause burns to rescuers exposed to them. Sewage from broken sewer lines can release toxic gases such as hydrogen sulfide or methane and can expose rescuers to bacteria.

#### **Hazardous Materials**

The California Health and Safety Code defines a hazardous material as "any material that because of its quantity, concentration, or physical or chemical characteristics, poses a significant present or potential hazard to human health or safety, or to the environment if released." Common examples are flammables such as gasoline, corrosives such as hydrochloric acid, and toxics such as pesticides.

The type of building affected and its normal contents will help identify potential hazardous materials that may be released during a collapse. Rescuers must be cognizant of this potential at residential dwellings as well as commercial establishments.

Residential hazardous materials can be found in kitchens, laundry rooms, garages, and sheds and may include ammonia, bleach, oven and drain cleaners, spot removers, gasoline, paint thinners, pool chemicals, pesticides, herbicides, and other garden supply chemicals.



# RESCUE SYSTEMS 1

## Basic Rescue Skills



### Topic 1-3: US&R Safety and Medical Care for Victims

Commercial establishments that are common to most cities and towns and their associated hazardous materials include:

- Supermarkets, hardware stores, and sporting goods stores
  - Paint and paint thinners
  - Caustic paint removers and oven cleaners
  - Pesticides and herbicides
  - Aerosol cans
  - Liquid and powdered chlorine
  - Muriatic acid flammable gases
  - Gunpowder and ammunition
- Schools
  - Gases and flammable liquids
  - Cleaning supplies
  - Poisons
  - Biological hazards in chemistry and biology classrooms
- Hospitals and laboratories
  - Flammable and toxic gases
  - Flammable liquids
  - Poisons
  - Cryogenic liquids
  - Radioactive and biological hazards

### Other Hazards

Rescuers may face additional incident hazards that do not fall into any previously listed categories. Some of these hazards are related to the cause of the collapse and others are actually created by rescuer actions. Fire, smoke, or explosions force responders to wear a higher level of personal protective gear than in normal collapse operations. The collapse may have resulted from the fire or explosions, or the fire and smoke may be the result of the collapse. Secondary explosions may be caused by a secondary explosive device intended to harm the rescuers.

It is important for rescue workers to realize that a collapsed structure will be much more susceptible to fire after the collapse and the fire much harder to extinguish. This is due to the disruption of any built-in suppression systems, disrupted utilities, and the larger surface-to-mass ratio of the splintered flammable building materials and deep difficult-to-access debris piles.

Vibrations from various sources are a safety concern to rescuers, because these can cause a secondary collapse of unstable building parts. Vibration sources can include:

- Rail traffic, such as trains and subways
- Vehicular traffic on nearby roadways

- ❑ Air traffic or helicopters over the collapse site
- ❑ Heavy construction equipment
- ❑ Responding fire and rescue apparatus

Particulate matter such as smoke, concrete dust, and asbestos must be recognized and appropriate personal protective equipment (PPE) must be worn to prevent this material from entering a rescuer’s respiratory system. Exposure to particulate matter can cause immediate and long-term problems if not appropriately mitigated.

Rescuers will be faced with several hazards created by their own actions, such as operating internal combustion engines and power tools within confined areas and contaminating the atmosphere. Rescuers may have difficulty operating heavy tools in small and cramped spaces in awkward positions causing potential muscle strain.

Loud noises will be created by rescuers using power tools inside confined areas and while operating heavy construction machinery. This can cause damage to rescuer hearing, ineffective communications, and the inability to hear structural element movement and a victim’s calls for help.

Uncoordinated rescue operations and unorganized rescue teams can add weight and cause unnecessary movement above other rescuers.

## Four General Types of Building Construction Hazards

### Light-Frame Construction

Light-frame construction refers to residential homes and apartments of up to four stories and principally constructed of wood. The principal weakness of light-frame buildings is the lateral strength of the walls and the connections. Because of this weakness, collapses may occur when lower-level walls are too weak to resist lateral forces applied on the building. Heavy loads on these weak walls can result in complete collapse. Part or all of the building can fall, projecting away from the building’s original foundation. This may result in upper stories collapsing due to the first-story failure. These types of structures are highly susceptible to fire because of disrupted utilities and high surface-to-mass ratio of splintered wood and other light-frame materials.

Rescuers operating at a light-frame building collapse should check for stability problems by looking for badly cracked walls, leaning walls, an offset of the structure from the foundation, or a leaning first story in multifloor dwellings.

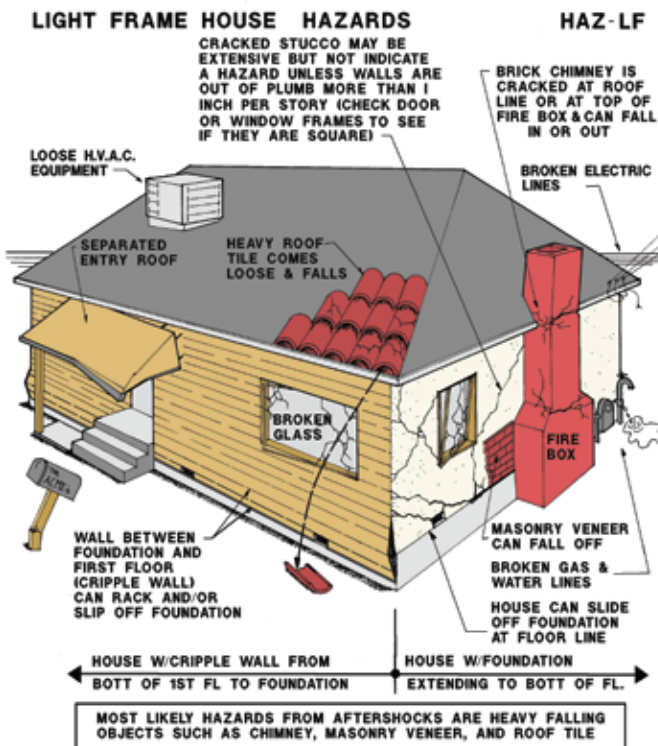


Figure 1:12 Light Frame Construction



In addition, cracked and leaning masonry chimneys and separated porches, split-level floors, and roofs should be evaluated. Other hazards include broken utility connections, loose heavy roof tiles, HVAC, or solar equipment.

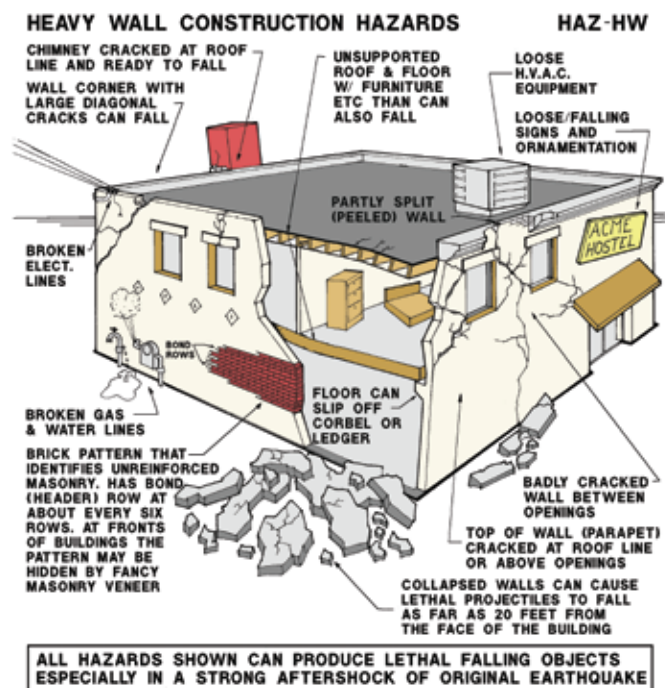


Figure 1:13 Heavy Wall Construction

## Heavy Wall Construction

These buildings are one to six stories in height and may be residential, commercial, industrial, or institutional. They have heavy and thick walls and wooden or lightweight concrete floors. Their principal weakness is in the lateral strength of the walls and the connections between the walls and floor or roof assemblies. Collapses are usually partial and are due to the heavy, weakened walls falling away from the floors. Falling hazards are very common at these buildings due to the amount of small, loose masonry components resulting from the collapse. When operating in an unreinforced masonry (URM) building, make sure to check for loose and broken parapet walls and ornamental masonry, broken connections between walls and floors, cracked wall corners, and unsupported and partly collapsed floors. Other hazards include broken utility connections, loose signs, HVAC, or solar equipment.

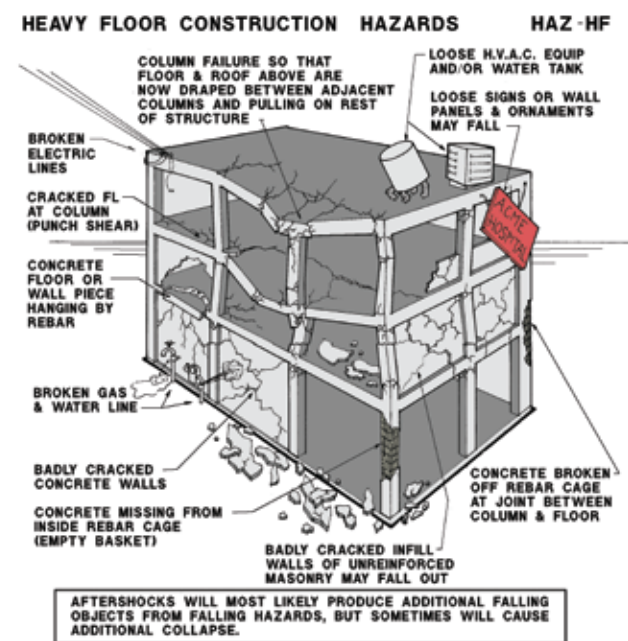


Figure 1:14 : Heavy Floor Construction

Buildings with tilt-up/reinforced masonry walls generally are industrial and commercial buildings, one to five stories tall. Their principal weakness is in the connection between the wall and the floors or roof. Typical failures result in the wall falling away from the floor or roof edge. This can result in the top of the wall falling as far away from the building as its height. When operating at these structures, rescuers must perform an effective evaluation that should include checking the connections between the wall and floors and between the wall and the roof. Also, check the connection between beams and columns, and look for badly cracked walls or columns.

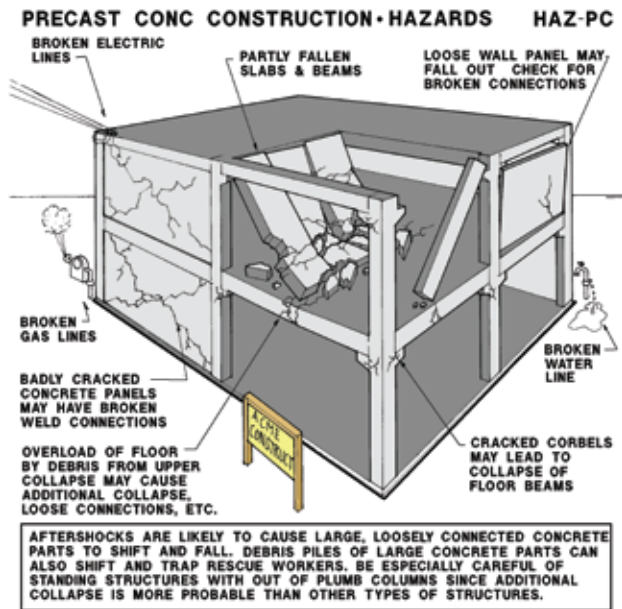


Figure 1:15 : Heavy Floor Construction

## Heavy Floor Construction

Structures in this category can be residential, commercial, or industrial. They have concrete frames and may be up to twelve stories tall. This category includes concrete highway bridges. The principal weakness of these structures is the poor column reinforcement and inadequate connections between floor slabs and columns. Collapse from the failure of these parts can be partial or complete.

These structures often fall down on themselves, or they may fall laterally if the columns are strong enough. Other hazards include broken utility connections, loose signs, HVAC, or solar equipment.

Rescuers should evaluate the stability of the structure by checking the following areas: 1) the confinement of the concrete within the reinforcement of the columns; 2) cracking of columns at each floor line; 3) diagonal shear cracking in major beams adjacent to supporting columns; and 4) cracks in shear walls.

## Precast Construction

Precast structures may be commercial or residential and include precast parking facilities. These structures generally are one to twelve stories in height. Principal failure is due to the weakness of the connectors used to connect building parts such as floors, walls, and roof. The weak connectors fail during earthquakes or other failure-causing events. These failures will often create many falling hazards as precast sections break loose and become unstable. Rescuers operating at a precast building collapse should check beam-to-column connections for broken welds and cracked corbels. Column cracking at top and bottom joints, as well as wall panel connections and shear wall connections at floor areas, must be checked to determine the stability of the structure. Other hazards include broken utility connections, loose signs, HVAC, or solar equipment.

## Four Types of Collapse Patterns

Most collapses result in the original shape of the building being significantly changed. The rescuer can find any one or a combination of four types of collapse patterns because of these changes. The four types of collapse patterns are generally associated with heavy wall construction but may be present in all type of construction.

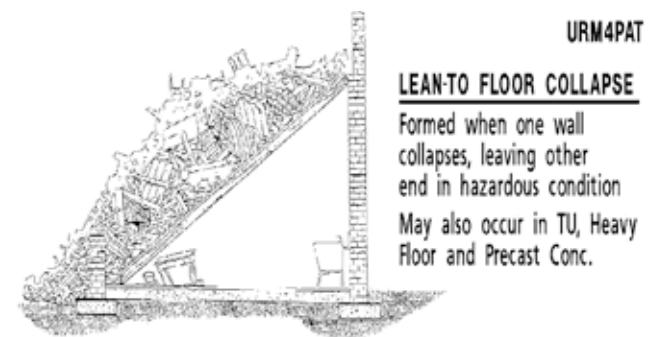


Figure 1:16 Lean-to Collapse

## Lean-to Collapse Pattern

The lean-to collapse pattern is often formed when a wall failure causes a floor or roof section to fall completely on one side, while the other end remains supported. This collapse usually results in a triangular-shaped void that is considered a survivable void space. A survivable void is an area where the likelihood for survival of victims is high.

Remember that the remaining supported end of the fallen section may be precariously attached and could require additional support. Shoring may also be required on the outside of the wall supporting the floor or roof if rescuers must perform void exploration and extrication. Rescuers may find victims inside the void space under the floor or roof and under of the debris pile.

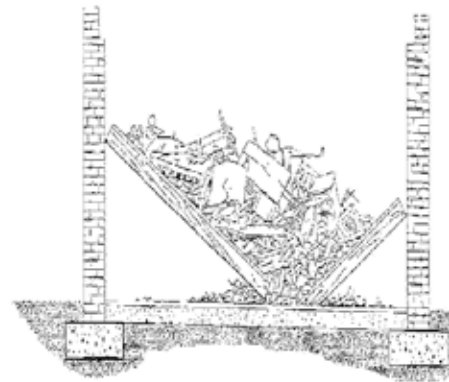


Figure 1:17 V-shape Collapse

## V-Shape Collapse Pattern

The V-shape collapse pattern will be created when a floor assembly collapses in the middle due to failure of center supports or overload of the floor. The result is two identifiable voids that are created on each side of the broken floor assembly. Victims can be found in these two survivable void areas as well as under the debris pile. Shoring may be required on the outside of both walls supporting the floor sections.

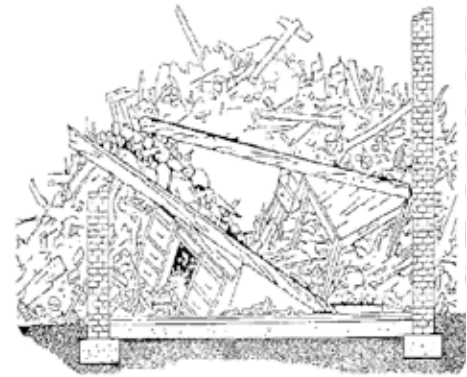


Figure 1:18 Pancake Floor Collapse

## Pancake Collapse Pattern

The pancake collapse pattern is formed when single or multiple floors and/or roof collapse, resulting in a layering effect. The resulting voids are limited in space and are difficult to access, especially in concrete structures. Victims are often found in the small spaces created where the floors are separated by supporting building contents such as furniture, appliances, or equipment.

Broken structural components that have fallen between the floor slabs during the collapse also may act to support the floor and create a void area. Rescue access is made by horizontal access through existing or created openings. Breaking and breaching through floor slabs from above or below may be necessary to gain access into the void areas.

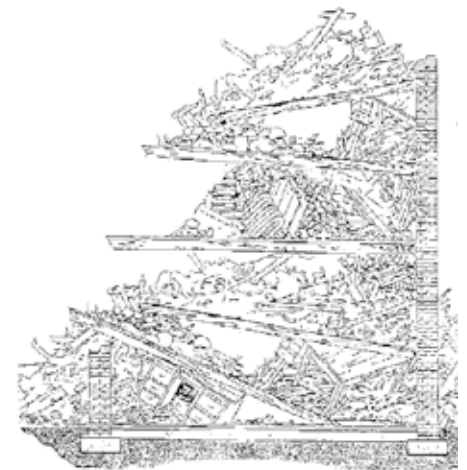


Figure 1:19 Cantilever Floor Collapse



# RESCUE SYSTEMS 1

## Basic Rescue Skills



### Topic 1-3: US&R Safety and Medical Care for Victims

#### **Cantilever Collapse Pattern**

The cantilever collapse pattern is formed when a wall collapse results in one end of the floor(s) and/or roof hanging unsupported and suspended above the other floor(s) on the side where the wall failed. The opposite end of the floor assembly remains attached to the wall at its original connection point.

This type of collapse pattern is extremely unstable and dangerous. Extensive shoring is required to make the area safe before any search and rescue operation. Rescuers must use good judgment and extreme caution when operating in this area. Victims may be found in the void spaces under the hanging floor or roof.

#### **Personal Protective Equipment**

The first response to a structural collapse will bring a wide variety of willing rescuers to the scene, including law enforcement officers, firefighters, emergency medical personnel, hospital employees, public works employees, private sector contractors, and untrained civilian volunteers. These responders may arrive with varying degrees of personal protective equipment ranging from very inadequate to highly efficient. For rescue work in an area strewn with broken glass, protruding nails, and jagged metal, normal street clothing or light work uniforms are not adequate.

Personal protective equipment is required to protect against abrasion from sharp objects, puncture wounds of the feet and hands, head injuries from falling objects and accidental impact, eye injuries from flying objects, twisted ankles, burns from fire, lung injuries from dust, and hearing damage from loud noises. Personnel performing rescue operations must use the following personal protective equipment to limit injuries:

- Breathing Apparatus.** Required for protection from hazardous vapors, smoke, and oxygen-deficient atmospheres less than 19.5 percent. Self-contained breathing apparatus has a limited air supply and should not be taken off to access small spaces. Supplied air line systems provide longer duration of use and entry into smaller areas.
- Communication Equipment.** A portable two-way radio and a personal alarm device.
- Dust Mask.** Common paper-type dust masks do not effectively filter out small particles or asbestos. Canister respirators with proper filters are more effective.
- Eye Protection.** Safety goggles and glasses. Regular prescription glasses, sunglasses, or fold-down shields on helmets are not adequate.
- Flame-Resistant Clothing.** Brush fire clothing, coveralls, or heavy work clothing with long sleeves. Structural firefighter clothing is often too confining and hot and will quickly tire the rescue worker.
- Flashlight or Headlamp.** At least two light sources at all times, in case one fails.
- Hearing Protection.** To protect the wearer from loud noises generated by power tools and heavy construction equipment.
- Helmet or Hard Hat.** Structural firefighter helmets are usually too confining and heavy for structural collapse rescue work.
- Knee Pads.** To protect the knees of rescuers while crawling.
- Leather Gloves.** To protect the hands from abrasions, cuts, and punctures.
- Safety Boots.** Recommend steel toe and shank.



# RESCUE SYSTEMS 1

## Basic Rescue Skills



### Topic 1-3: US&R Safety and Medical Care for Victims

#### **Safety Considerations**

The IC, the Safety Officer and Assistant Safety Officers, supervisors, and all rescue workers must consider safety as an integral part of the overall action plan. Safety considerations must be adhered to throughout the incident.

#### **Safety Officer Duties and Responsibilities**

The assignment of a Safety Officer is one element of providing and maintaining a safe operational work environment. At least one Safety Officer should be assigned to each work unit or rescue team. They should position themselves in a safe area where they can oversee the work site to look for hazardous conditions or inappropriate worker actions. Safety Officers should not engage in the actual rescue work, as this will limit their ability to concentrate on overall unit safety.

The overall incident Safety Officer and his/her assistants should use a safety checklist as a reference guide to make sure all safety issues are reviewed, analyzed, and properly addressed. They must also monitor the entry times and work duration of rescuers who enter the building or void space. This ensures accountability of personnel.

Rescuers will have a natural tendency to want to continue to work without a break. Safety Officers must ensure that all workers adhere to a rotation period to lessen the potential for injury from overwork.

#### **Buddy System**

Working in and around collapsed structures is hazardous, and the potential is high for injury to rescuers. Rescuers should consistently work within a buddy system, in teams of at least two persons, working and staying together at all times while on the incident scene. When working in a danger area, in a void space, or inside the structure, workers must remain together and communicate; if one person is required to leave, then all must leave. This is required to enhance the safety of rescuers and to maintain accountability of rescue personnel.

#### **Lookouts, Communications, Escape Routes, and Safe Zones (LCES)**

The acronym LCES stands for Lookouts, Communications, Escape Routes, and Safe Zones, which are the areas that must be addressed in all operations and safety plans to ensure the safety and accountability of all response personnel.

#### ***Lookouts***

The lookout function is normally assigned to the Safety Officer, but is everyone's responsibility.

#### ***Communications***

Effective communications at a structural collapse scene are an absolute necessity. Rescuers must clearly and consistently report their status and maintain contact with their supervisors and the Incident Commander (IC). This is especially important for personnel operating in hazard areas. A formal radio communications plan must be developed so all personnel on the rescue site know who is assigned to which radio frequencies. Each rescue team member should have a portable radio for optimum communications effectiveness. Communications must be maintained through voice, touch, or sight. Inside rescue team members must maintain contact with their buddies. Team leaders must be made aware of progress, welfare, and needs on



# RESCUE SYSTEMS 1

## Basic Rescue Skills



### Topic 1-3: US&R Safety and Medical Care for Victims

a timely basis throughout the operation. It is also important that predetermined hand signals are known, recognized, and practiced by all team members.

In situations where rescues require the interaction of multiple rescue teams, search teams, and other rescuers such as public works personnel, make sure information is communicated to these people when your actions will affect their operations.

### Emergency Signals

Because of the high potential of secondary collapse, dangerous conditions, and the need to communicate other important information, an emergency signaling system should be adopted and in use by all personnel at the incident site. Emergency signals must be loud and identifiable and sounded when conditions require immediate attention. Emergency signals can be made using devices such as a whistle, air horn, vehicle horn, or bell. In order to reduce confusion, each structure or larger area of operations may need to have its own distinct emergency signal device when multiple rescue operations are taking place in the same area.

Supervisors should identify and inform assigned personnel of a designated place of assembly or safe zone for a Personal Accountability Report (PAR) to be conducted should an evacuation signal be sounded. A place of assembly is usually a safe location outside the evacuation area. A safe zone is usually a safe location within a building or disaster site that can be entered within the evacuation area. When an evacuation signal is sounded, all supervisors must conduct a roll call of their assigned personnel and communicate the results of the PAR to their supervisor.

Evacuate the area	Short signals repeated for 10 seconds, pause for 10 seconds, and repeat for 3 repetitions. Total signal time – 50 seconds.
Cease operations/all quiet	One long signal (8 to 10 seconds).
Resume operations	One long and one short signal.

If rescuers become trapped, they should immediately attempt to communicate with other team members, team leaders, a supervisor, the IC, or anyone outside the structure.

Communication methods can include portable radios equipped with an emergency trigger, personal alarm devices, and shouting for assistance. Tapping a solid object onto a solid part of the structure can sometimes be heard farther away than shouting for assistance or a personal alarm device. A suggested entrapped signal is the same that the hailing search method uses, which is a continuous five taps – pause – five taps – pause.

### *Escape Routes*

Rescuers must preestablish a path to an area of safe refuge. The safest method of exiting an area may not be the most direct route that may be in the path of collapse or falling hazards. Remaining in place may be an option if the area is safe or can be made safe with shoring or removal of hazards. Escape route access and direction may change throughout the duration of the rescue operation. The escape plan should be constantly updated to reflect changing situations and the new plan must be communicated to and acknowledged by all affected personnel.



# RESCUE SYSTEMS 1

## Basic Rescue Skills



### Topic 1-3: US&R Safety and Medical Care for Victims

#### ***Safe Zones***

Safe zones, also referred to as safe havens are preestablished areas of safe refuge, safe from known or potential hazards. These areas can be designated outside the hot zone or agreed-upon safe areas within the hot zone. If the safe zone is within the hot zone, rescuers may have to construct a shoring system or remove hazards to make the area safe enough to remain in place.

The safety plan must provide for a personnel accountability check or head count to be conducted in a safe zone after an evacuation signal is sounded. The results of the personnel accountability check must be immediately provided to the supervisor, who forwards this information through the chain of command to the IC.

#### **Personnel Accountability System**

A personnel accountability system must be in place to keep track of all team members at all times through their supervisor. If adequate staffing allows, assign a Personnel Accountability Officer to conduct or supervise this important function. Periodic personnel accountability checks should be conducted during the duration of the incident and immediately after an evacuation.

#### ***Rescue Team Hydration***

Dehydration of rescue team members can occur quickly during heavy work periods. Each rescue team member should consume at least 8 to 12 ounces of water or electrolyte supplement every 30 minutes during heavy work periods. Coffee, tea, and caffeinated liquids can increase the dehydration process.

#### ***Rescue Team Rotation***

Rotate teams on a regular basis. During heavy work periods, some teams need to rotate every 15 to 30 minutes. Rescuers have a tendency to want to work longer periods without a break. Monitor and track entry times and work duration periods. If the rescue situation allows, rotate crews in an overlapping arrangement. This means that not all rescuers who are actively involved in doing the hands-on work should be relieved at the same time.

Remove and replace only part of the crew at one time to allow the new workers to become accustomed to the plan of action and the rescue tactics being applied. This overlap of personnel may allow for the smoother transition of operations and a more effective rescue.

#### ***Personal Hygiene***

All personnel on the rescue site should wash their hands and face with soap and potable water before eating. Lavatory facilities and hand washing stations must be provided for long-duration rescue operations. Only eat food and drink liquids that have been properly prepared and stored by trained personnel such as the American Red Cross or Salvation Army. Eating and drinking items brought to the scene by well-wishing civilians may cause illness and can render a rescue team member or an entire rescue team useless.

#### ***Stress Factors Awareness***

Rescue operations at a collapsed building will be very taxing on everyone involved. Safety Officers, supervisors, and all team members must be aware of the potential for critical or extended incident stress and how it will affect rescue workers. All team members must also be aware that prolonged rescue



# RESCUE SYSTEMS 1

## Basic Rescue Skills



### Topic 1-3: US&R Safety and Medical Care for Victims

operations, fatigue, the sight of multiple deaths and injuries, and the frustration of wanting to do more can create potentially debilitating stress levels in rescue workers. All team members need to monitor themselves and other team members for critical or extended incident stress signs and symptoms, which may include a significant change in a person’s usual personality, withdrawing from the group, inability to sleep, nightmares, loss of appetite, and use of drugs or excessive amounts of alcohol.

In order to limit the effects of critical or extended incident stress and personal injury to responders, crews should be rotated on a regular basis to a rehabilitation area. This is especially important if operations will last for many hours or several days. It is important to provide rescuers in the rehabilitation area with:

- Shelter from the weather
- An opportunity for rest and sleep during prolonged incidents
- Food, drink, and lavatory facilities

### **Basic Medical Considerations**

A structural collapse incident can cause multiple victims to be injured in a variety of ways and locations. Using some basic medical care and safety procedures during the rescue operations will greatly assist in providing the most victims with the best possible chance for recovery.

It is imperative that rescuers not lose sight of their primary objectives in responding to structural collapse incidents. Rescuers must be able to stabilize or maintain the existing situation and access, and stabilize and remove victims without further harm.

Before beginning rescue operations, the IC should establish a location to place injured victims. This location is often known as a casualty collection point (CCP) or treatment area. If rescue operations begin before establishing a CCP, victims from the incident are often gathered and placed at different and multiple locations, which makes triage, treatment, and transport more difficult. Use established triage procedures to sort multiple victims to do the most good for the most people with the limited resources available.

### **Determine Likelihood of Victim Survival**

Another consideration of the IC is the potential for survival of the victims, based on the type of collapse situation and on the length of time the victim has been trapped. Research done after several earthquakes with entrapped victims has illustrated that survival is proportional to the length of time a victim is entrapped. The greatest chance of survival occurs within the first 24 hours, and 80 percent of those who can be saved will usually be rescued within that time period.

Typical survival rates of trapped victims:

- 30 minutes . . . . .91% survive
- 1 day . . . . .81% survive
- 2 days . . . . .36.7% survive
- 3 days . . . . .33.7% survive
- 4 days . . . . .19% survive
- 5 days . . . . .7.4% survive





# RESCUE SYSTEMS 1

## Basic Rescue Skills

### Topic 1-3: US&R Safety and Medical Care for Victims



## Injuries Associated with Structural Collapse

A collapsed structure places significant forces on a victim's body and the contents of a structure have tremendous potential to cause injury in a collapse. The time of day of the structure collapse can be a possible indication of the type of injury rescuers may encounter. A higher instance of head, neck, and back trauma can be expected during the day and early evening when people are normally in standing and sitting positions. A higher instance of broken bone, soft tissue, and crushing injuries can be expected during the late evening and early morning hours when people are normally laying in bed or trying to escape with less than adequate clothing or protection.

## Other Medical Concerns

**Hypothermia**, or decreased body temperature, is a concern in cold temperatures when the victim may have been exposed to the environment for extended periods of time. Wet clothing, lack of normal heating and insulation systems, building components that absorb heat, inability of the victim to move, and existing weather conditions all increase the possibility of hypothermia. Rescuers must protect the victim from the environment during the rescue effort.

**Hypovolemia**, or a loss of blood volume, can occur as a result of impacts and injuries to the body as a structure collapses. Shock as a result of hypovolemia is a life-threatening problem. Rescuers must stop the bleeding and provide oxygen and intravenous fluid replacement if possible.

**Inhalation injuries** result from many sources during a structural collapse. Large quantities of dust are a significant irritation to the respiratory system and may even suffocate the victim. Rescuers should be prepared to protect both themselves and victims from dust.

**Other respiratory problems** can result from hazardous atmospheres created by the escape of normally contained products. Examples include natural gas and on-site hazardous materials. It is important to protect both the victim and the rescuer from these hazardous environments throughout the rescue effort.

**Dehydration**, or inadequate fluid intake, becomes a concern based on the environment and the length of time the victim is trapped. Drinking fluids is the best way to improve hydration, but in many cases this is not possible. In these situations, the best solution to the hydration problem may be an intravenous line started by Advanced Life Support (ALS) personnel before removal of the victim from the structure.

**Nutrition** also becomes a concern, especially as the length of time of the incident increases. This should be addressed by ALS personnel trained to deal with this type of situation.

**Compartment syndrome** can occur when a victim's limb has been trapped for more than four hours. The limb swells until the skin is stretched to its maximum. These victims will need ALS care and aggressive surgery to relieve the pressure to save the limb and possible amputation to save the victims' life.

**Crush syndrome** occurs as a result of crushing pressure on certain parts of the body, typically the lower extremities. When blood flow to and from the injured area is absent for more than four hours, the injured tissue dies and gives off toxins. A sudden release of pressure allows the toxins to flow into the bloodstream, where they could have an effect on other organs in the body and possibly cause death. Crush syndrome has been called the "grateful dead" syndrome because the victim is appreciative and talking to the rescuers while



# RESCUE SYSTEMS 1

## Basic Rescue Skills



### Topic 1-3: US&R Safety and Medical Care for Victims

trapped and during the extrication, but, once freed, the toxins are released and the victim dies. Rescuers must be able to recognize crush syndrome as a possibility and provide treatment prior to victim extrication.

#### **Contact/Consult Medical Resources**

If available, ALS personnel familiar with crush syndrome should provide treatment for the victim. High-flow oxygen by nonrebreather mask, large volumes of intravenous fluids, cardiac monitoring, and certain medications are appropriate for treatment before releasing the weight load off the victim.

The longer a victim is trapped, the greater the long-term effect; the greater the entrapment time, the lower the chance for long-term survival. Compartment and crush syndromes become concerns after four hours and a certainty after six hours.

Personnel on scene must contact and consult with available medical resources. Structural collapse incidents are long in duration (typically greater than eight hours). Victims' conditions may be unstable, and rescuers may not be able to move them because they are trapped. Compartment and crush syndromes require specific ALS medical treatments. This treatment must be administered or supervised by trained personnel familiar with structural collapse injuries. Moving a victim may require very careful handling to minimize the possibility of further injury.

#### **Potential Treatment by Rescuers**

- Use high-flow oxygen by nonrebreather mask.
- Perform cervical spinal immobilization.
- Monitor cardiac activity.
- Administer certain ALS medications.
- Immobilize and package the victim for removal.
- Maintain body temperature.
- Protect the victim from the environment; consider helmet, eye protection, and dust mask or oxygen mask for victim.
- Protect the victim from rescue activities, such as sparks, breaking and breaching debris, and accidentally dropped tools and equipment.

#### **Victim Movement over Debris Piles**

If possible, rescuers should not walk over uneven, unstable, or slippery surfaces while carrying victims. Rescuers should secure footing, form a human chain, and pass the victims from rescuer to rescuer. Placing a victim on a backboard or other stable stretcher-type device will provide a secure platform with good handholds for the rescuers.

#### **Basic Infectious Disease Safety**

If victims do not have a disease prior to injury or death, they do not become infectious because of the injury or death. Rescuers should take basic infectious disease safety precautions, which includes wearing the same PPE to protect themselves from other types of structural collapse hazards. Use PPE for cuts, abrasions, eye, and respiratory protection. Additional PPE is needed for potential contact with body fluids. Rubber latex gloves put under the leather work gloves will prevent damage to the rubber gloves during



# RESCUE SYSTEMS 1

## Basic Rescue Skills



### Topic 1-3: US&R Safety and Medical Care for Victims

work activities. If significant contact with body fluids is expected due to the rescue operation, rescuers should wear a moisture barrier over their work clothes, such as Tyvec disposable coveralls and shoe covers often used at hazardous material incidents.

#### **General Infectious Disease Safety Rules**

- If it is warm and wet and not yours, get it off you as soon as possible.
- If in contact with body fluids, wash with soap or mild disinfectant as soon as possible.
- Wash your hands and face before eating anything.
- Remove and wash clothing with soap and water as soon as possible if in contact with body fluids.
- Immunizations against hepatitis and tetanus should be kept current.
- If contact with a significant amount of body fluid has occurred, rescuers should consider decontaminating boots, gloves, and outerwear with soap and water or a mild disinfectant.



# RESCUE SYSTEMS 1

## Basic Rescue Skills

### Topic 1-4: US&R Planning and Preparation



## Topic 1-4: US&R Planning and Preparation

**Scope:** This chapter serves as an introduction to US&R planning and preparation.

**Terminal Learning Objective (TLO):** At the end of this chapter, the student will be familiar with structural collapse incident organization and management. If an effective system to direct and control the large volume of personnel, equipment, and arriving resources is not in place, the person in charge will be overwhelmed. The order in which specific functions and tasks are performed will be vital to the effectiveness of mitigating the search and rescue structural collapse incident. Planning is probably the single most important function for an effective response to structural collapse incidents. Proper planning will identify the legal authority and responsibility for specific actions, develop a vulnerability and hazard assessment, and identify resources, response coordination, training, and budgetary needs.

**Enabling Learning Objectives (ELO):**

1. Describe the legal authority and responsibility for US&R.
2. Describe the development of a vulnerability and hazard assessment.
3. Identify resources for a US&R incident.
4. Describe an effective response coordination.
5. Describe the training needed for local resources.
6. Describe budgetary needs during a US&R incident.
7. Describe the ICS, SEMS, and NIMS as they relate to a US&R incident.
8. Describe the communications necessary for a US&R incident.
9. Describe scene control.
10. Describe federal and state resources.

### **Establish Legal Authority and Responsibility**

Planning is probably the single most important function for a proper and effective response to structural collapse incidents. Planning needs to be done by every organization that could be involved in responding to these types of incidents.

One of the most common problems at a major rescue incident is the time wasted trying to decide who is in charge and who is responsible. If those questions are not answered ahead of time, confusion and duplication of effort will result.

During the planning process, the legal authority should be identified. Local codes, ordinances, and policies will dictate what organization or agency has the legal authority for search and rescue. The fire department may have the legal authority only in urban environments, and law enforcement may have the legal authority in wilderness environments or for search and rescue incidents resulting from a natural disaster or both. State laws identify when state resources can be called to help, and federal laws dictate when federal resources can be activated.

Once legal authority has been determined, the identification of who is responsible for specific actions at an incident site must be established.



# RESCUE SYSTEMS 1

## Basic Rescue Skills



### Topic 1-4: US&R Planning and Preparation

The fire service is responsible for fire suppression. No other agency can perform that function, so it becomes the fire service's primary responsibility. If a community relies entirely on the fire service to perform search and rescue from collapsed structures and there is a major fire at the same time, then the rescue of victims from that collapsed structure may have to wait. That may not be acceptable.

Traditionally, the fire service is also responsible for initial emergency medical services, hazardous material incident response, and many forms of rescue.

Law enforcement is responsible for security, site control, crime scene investigation, and, in some cases, search and rescue. Structural collapse incidents where people are killed or injured need to be handled as potential crime scenes. Some law enforcement agencies may believe that structural collapse rescue training is only for the fire service. A quick review of the 1989 Loma Prieta, California, earthquake, 1994 Northridge, California, earthquake, and 1995 Oklahoma City, Oklahoma, bombing will reveal that almost every law enforcement agency in the affected area was heavily involved in rescue situations.

Other agencies and organizations have vital roles to play in structural collapse incidents, and those roles need to be identified before an incident occurs.

### **Develop a Vulnerability and Hazard Assessment**

A vulnerability and hazard assessment will allow you to find out how susceptible your community is to certain types of events that could cause a disaster. What could happen in the future?

- CBRNE (Chemical, Biological, Radiological, Nuclear, Explosive)
- Earthquake
- Explosion
- Flood
- Hurricane
- Landslide
- Snow/avalanche
- Terrorist acts
- Tornado
- Tsunami
- Windstorm

Determine community vulnerability by researching what has happened in the past. If it has happened once, it might happen again. Take the opportunity to learn from historical events that have occurred within your community and neighboring communities. Identify the problems that existed or potential problems that could exist when these events occur and develop a plan of action to deal with them.

Survey your community for potential hazards near dams with a large population in the downstream impact zone, old and unreinforced masonry structures, power-generating stations, chemical plants, and low-lying areas susceptible to flood, landslide, and snow avalanche.



# RESCUE SYSTEMS 1

## Basic Rescue Skills



### Topic 1-4: US&R Planning and Preparation

Historical and current information pertaining to community vulnerability and hazards can be found in your local building department, geological organizations, and local and state emergency management agencies.

#### **Identify Resources**

By identifying the hazards and potential problems, you can identify available resources to solve the problem. If the resource does not exist within your community, you obtain it or you can identify resources from outside your community and arrange to use them through local mutual-aid agreements.

Local jurisdictions must use available resources first. When local resources are overwhelmed, additional resource requests are routed through mutual-aid agreements, then to the county, to the state, and eventually to the federal government.

Local authorities maintain command and control of local incidents even when state and federal resources are requested.

Resource lists should be included within the plan. The lists should identify:

- The resource
- The resource capability
- How to contact the resource
- The resource response time
- Any other pertinent information

#### **Local Resources**

Local resources may include:

- Fire service and law enforcement
- Local emergency medical service providers
- Community Emergency Response Teams (CERT) or Disaster Assistance Response Teams (DART) from businesses, schools, and industry
- Volunteer search and rescue teams traditionally used in wilderness situations
- Public works departments and utility companies with heavy equipment and tools for breaching roadway surfaces and lifting heavy objects
- Heavy equipment and construction trade unions and companies
- Sewer companies, which may have remote cameras for surveying sewer lines that could be used in searching void spaces

#### **State Resources**

State mutual-aid agreements allow fire and law enforcement agencies to cross jurisdictional borders to assist affected areas.

The governor of a state can declare a State of Emergency and activate state resources such as the National Guard to assist local jurisdictions.



# RESCUE SYSTEMS 1

## Basic Rescue Skills



### Topic 1-4: US&R Planning and Preparation

#### **Federal Resources**

Implementing the National Response Plan (NRP) for an incident of national significance is determined by the Secretary of Homeland Security. Federal resources are organized into fifteen (15) Emergency Support Functions (ESF) within the NRP. US&R makes up ESF-9.

#### **Response Coordination**

The first local emergency service provider on scene is responsible for on-site incident management and coordination. It must immediately establish command, provide initial orders to arriving resources, and request additional resources as needed. The person in charge may change throughout the incident as higher-ranking supervisors arrive. A unified command structure may be necessary due to the involvement of multiple agencies and jurisdictions having statutory or political responsibility or authority. Large incidents may require the activation of an EOC to coordinate and support multiple resources.

#### **Emergency Operations Center (EOC)**

The EOC may be identified by a different name, but whatever the name, it is the place where incident information is collected and executive policy decisions are made that result in resource coordination, support, and emergency response. At the EOC, the overall disaster priorities are established and resources are allocated. It provides a single point for collection, evaluation, display, and dissemination of information. It facilitates verification of information, which helps control rumors.

The EOC gathers and processes a wide variety of incident information such as:

- Location of problems and number of victims
- Available resources and assistance needs
- Road and infrastructure status
- Evacuation center and shelter locations
- Anticipation and planning for future needs
- Documents for recovery assistance and future planning

The EOC is also used to consolidate and disseminate incident information to:

- Responding and assisting resources
- Politicians and the civilian population
- Media
- Agencies requesting assistance
- State agencies and federal authorities

The EOC can be a large, complex command center with the latest in communications and technology, or it can be the place with the only working telephone. In either case, it is a vital link in the successful coordination of a major rescue incident.



# RESCUE SYSTEMS 1

## Basic Rescue Skills

### Topic 1-4: US&R Planning and Preparation



In a large multiple-site incident, each individual incident site will have its own Incident Commander (IC) and Command Post (CP). Each IC will send status reports and resource requests to the Department Operating Center (DOC) or directly to the EOC if a DOC has not been established. The DOC will forward status reports and resource requests to the EOC for overall incident resource coordination and support.

Each political jurisdiction should have an identified EOC and backup location, as well as identified and trained EOC supervisors and staff.

#### **Local EOC**

The local EOC gathers information on the severity of damage and their capabilities, and then relays this information to the county EOC. The local EOC requests additional resources through the county EOC when overwhelmed by the incident.

#### **County EOC**

The county EOC gathers information on the severity of damage and capabilities from local EOCs within its jurisdiction and relays this information to the state EOC. The county EOC coordinates the allocation and use of resources from unaffected communities within its jurisdiction. The county EOC requests additional resources through the state EOC when overwhelmed by the incident.

#### **State EOC**

The state EOC gathers information on the severity of damage and capabilities from the county EOCs and relays this information to the FEMA Regional Operations Center. The state EOC coordinates the allocation and use of state resources and the resources from unaffected counties and requests additional resources through the FEMA Regional Operations Center when overwhelmed by the incident.

#### **FEMA Regional Operations Center (ROC)**

The United States is divided into ten federal response regions. Each region gathers information on the severity of damage and capabilities from the state EOCs within its jurisdiction and relays this information to the Emergency Information and Coordination Center (EICC) in Washington, D.C. The FEMA ROC coordinates the allocation and use of resources within its jurisdiction and requests additional resources through the EICC when overwhelmed by the incident.

#### **Training**

Training should be provided to those local resources that will initially respond, such as the fire department, law enforcement, and emergency medical services. Local support resources that will respond when requested, such as volunteer search and rescue teams, public works departments, utility companies, and the American Red Cross, should also receive training. Those facilities or groups with large numbers of people, such as local government departments, schools, hospitals, commercial businesses, and the community, should be trained to reduce the impact on limited local emergency resources during a disaster or other significant incident.





# RESCUE SYSTEMS 1

## Basic Rescue Skills



### Topic 1-4: US&R Planning and Preparation

Training subjects should include, but not be limited to:

- Planning and hazard assessment
- Scene organization and management
- Safety and self-sufficiency
- Basic first aid and cardiopulmonary resuscitation
- Basic search procedures and lifting techniques
- Basic utility control and fire extinguisher use
- Specialized training for the local resources that will attempt to mitigate the more hazardous structural collapse situations

### **Budgetary Needs**

Budgetary needs will be identified during the Urban Search and Rescue Planning process. Those items may include, but will not be limited to:

- Tools and equipment to function at an identified operational level at the scene of a structural collapse
- Information packets, training supplies, and props
- Disaster supplies and communication equipment
- EOC training and facility equipment needs
- Mitigation measures to address identified vulnerabilities and hazards
- Funding for equipment maintenance
- Funding for continuing education

### **The Incident Command System (ICS)**

#### **Organized Approach to Managing Any Incident**

The ICS allows an organized approach to managing any emergency incident. It is adaptable to any incident, large or small. It is also adaptable to any type of incident, such as a fire, emergency medical situation, flood, hurricane, earthquake, or structural collapse.

The ICS is universally applicable and acceptable. It allows for a logical expansion of command, personnel, and other resources as an incident escalates. It is adaptable to multiagency and multidiscipline response to incidents. By featuring common terminology, personnel from many disciplines and agencies can operate in one system.

Use of the ICS for an Urban Search and Rescue incident helps ensure uniformity and control of the response. It allows the incident to expand from a local response to a regional, state, or federal response with minimal loss of continuity. It increases the likelihood of the available resources being allocated properly, based on actual need. It also allows incoming resources to understand and fit into the local command structure.

The system expands in a logical manner by filling supervisory and functional positions only when needed. It limits the number of personnel responsible to each supervisor with an effective span of control usually limited to five persons per supervisor. Supervisors have overall functional responsibility for their



# RESCUE SYSTEMS 1

## Basic Rescue Skills

### Topic 1-4: US&R Planning and Preparation



assignment that allows reasonable control of personnel and rescue efforts and improves overall safety in the highly unstable rescue environment.

### **Major Functions Within ICS**

The ICS is divided into five major functions: command, operations, planning, logistics, and finance/administration.

The **Command** function is accomplished by the IC. This position is filled during every incident, whether it is a single-unit response or a multiagency, multidiscipline response. ICS ensures that the system can be expanded as the need arises. The IC is responsible for the overall management of the incident and determines the overall strategic goals for the incident with input from other members of the organization. Large disasters often employ a unified command emergency management structure. A unified command may have several persons with equal functional or jurisdictional responsibilities managing the incident and making jointly agreed upon decisions. One person remains in charge as the IC in a unified command structure.

The **Operations Section** is responsible for managing all operations directly related to accomplishing the tactical objectives identified in the Incident Action Plan (IAP). Search and rescue teams will work in this section. The Operations Section is managed by the Operations Section Chief.

The Operations Section may be further divided to lessen the span of control. The next method of reducing the span would involve dividing into a “branch.” The branch is a major functional or geographic segment of the Operations Section. A branch is managed by a Branch Director.

Groups are resources assembled at an incident to perform a special function in a branch, if activated. As an example, a Rescue Branch may be further divided into groups that include the Search Group and the Rescue Group. A group is managed by a Group Supervisor.

Divisions are smaller geographic areas of a branch, if activated. A large incident may be divided into Division A at one rescue site and Division B at a second, more remote rescue site. A division is managed by a Division Supervisor. Again, these additional components are established only to maintain a manageable span of control. All personnel must understand their position within the in-place ICS and operate through the chain of command.

The **Planning Section** is responsible for collecting, evaluating, and using all the information pertaining to the incident and developing the IAP for each operational period. The Planning Section helps determine the effectiveness of current actions and recommends alternate strategies. Planning also documents the actions taken during an incident and provides technical expertise as required. The Planning Section is managed by the Planning Section Chief.

The **Logistics Section** is responsible for providing all facilities, services, and materials in support of the incident. This includes such areas as food, shelter, supply, and communications. The Logistics Section is managed by the Logistics Section Chief.

The **Finance/Administration Section** is responsible for all financial and cost analysis aspects of the incident. This function oversees the documentation of time and costs associated with personnel, supplies, and equipment as well as the documentation of private resources used throughout the incident. The Finance/Administration Section is managed by the Finance/Administration Section Chief.



# RESCUE SYSTEMS 1

## Basic Rescue Skills

### Topic 1-4: US&R Planning and Preparation



### **The Standardized Emergency Management System**

Because of the 1991 East Bay Hills Fire in Oakland, California, Senate Bill 1841 was introduced by Senator Petris to establish the Standardized Emergency Management System (SEMS). The California legislature passed the bill into law in 1993. The intent of the law is to improve the coordination of state and local emergency response in California. The law is found in Section 8607 of the Government Code and requires local governments to use SEMS by December 1, 1996, when responding to emergencies in order to be eligible for state funding of response-related costs. SEMS is applicable to the following five response levels:

- Field (on-scene at incidents)
- Local government
- Operational Area
- Region
- State

SEMS incorporates the use of the ICS and is extremely valuable for multiagency or interagency coordination to facilitate decisions for overall emergency response activities, including the sharing of critical resources and the prioritization of incidents.

### **The National Incident Management System**

On February 28, 2003, President Bush issued the Homeland Security Presidential Directive (HSPD-5), which directs the Secretary of Homeland Security to develop and administer a National Incident Management System (NIMS).

According to HSPD-5, this system will provide a consistent nationwide approach for federal, state, and local governments to work effectively and efficiently together to prepare for, respond to, and recover from domestic incidents, regardless of cause, size, or complexity.

### **Six Major Components**

- Command and management
- Preparedness
- Resource management
- Communication and information management
- Supporting technologies
- Ongoing management and maintenance

The NIMS integrates the existing best practices into a consistent nationwide approach to domestic incident management that is applicable at all jurisdictional levels and across functional disciplines in an all-hazard context.



# RESCUE SYSTEMS 1

## Basic Rescue Skills



### Topic 1-4: US&R Planning and Preparation

## **Communications**

Communication, both on and off the scene, is an important part of organization. Communication allows resources to be used at the correct location and allows status and progress to be monitored throughout the incident.

### **On-Scene Communications**

On-scene communications are communications at the actual work site. The rules are the same for all communications during any incident. Communications from personnel on scene are channeled through the chain of command to the on-scene IC for proper action. If the proper action requires off-scene communication, this is communicated by the on-scene IC. This allows information to be passed in an organized manner to the proper level of authority.

### **Off-Scene Communications**

Off-scene communication includes communication to the overall IC off scene during a multisite operation. It includes communication to the communication center for additional resources or for information updates.

### **Effective Communications**

Effective communications must be two-way, traveling both up and down the chain of command. Two-way communication allows feedback to be provided as well as the status of the situation to be updated throughout the incident. Two-way communication allows concerns to be identified and addressed at each level of the organization/operation. It also allows for the specific identification and documentation of problems, the need for additional resources to be readily identified and acted upon, and the assurance that safety issues are identified and documented by all concerned.

### **Reasons for Communications**

Communications must take place for status updates, to identify hazards and safety issues, to direct and coordinate resources, and to request additional resources.

### **Communication Methods**

Communication methods include the vehicle or portable radio, hardwire telephone, cellular phone, fax, and pager. The use of a runner to pass information can be effective, depending on distance and terrain. A megaphone or loudspeaker and signaling devices, such as an air horn, whistle, or hand signals, may also be effective.

A computer with a modem may be used to send and receive information. This is especially effective if a system is in place to send and receive information before the incident.

All methods of communication have limitations. Radios have a limited number of available frequencies. These frequencies are often not compatible and could interfere with other operations. Some frequencies do not operate well in concrete structures. The 450 MHZ range seems to work best in these structures. A radio communication plan to identify who is using what frequency must be developed.

The telephone system may be out of service or may be overloaded due to a lack of available lines. The hardwire telephone limits movement. A cellular system can also be down with no available or full cellular receiver and transmission sites.

Runners may not communicate the message accurately and are subjected to hazards traveling across the rescue site. Using a runner is possible only when there are available personnel. A signal system is effective if the involved personnel know what the signals mean.

## Compatibility of Communications

Some guidelines must be followed when operating in a multiagency, multijurisdictional situation. Use clear text; state what you need in plain English. Transmit the message in plain English without the use of slang or “10” codes. The message must be short without extraneous detail, understandable, and spoken clearly at a reasonable pace.

Personnel should always use their assigned radio designations. Remember that your designation during a multiagency, multidisciplinary, and multijurisdictional response may not be your usual designation. The designation to be used will be assigned and confirmed by the IC or your immediate supervisor.

## Scene Control

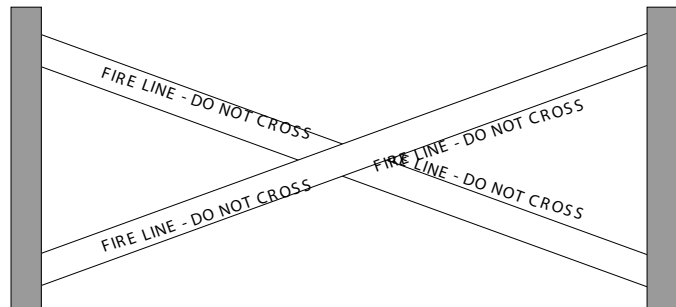
### Gain Control of the Site

Rescuers must gain perimeter control of the site as soon as possible. If you do not have control of the perimeter, you do not have control of the scene. This can be a very difficult task. The emotions of civilians trying to perform rescues are high. In many cases, people are trying to rescue family or friends and are reluctant to discontinue their efforts. It is very important for safety that the first-arriving rescuers control civilian rescuers at the site as soon as possible. The potential for a secondary collapse is great and, although they mean well, civilians may hamper the overall effort of the organized rescue personnel.

Spontaneous rescuers or convergent volunteers present before the arrival of trained rescue personnel can be a significant resource if organized and under the direction of the IC. Use caution with these resources when making assignments in hazardous or unsafe areas. It will be very difficult to remove spontaneous rescuers or convergent volunteers without providing them with another assignment due to their emotional attachment to the victims they may be attempting to rescue. Manage all interactions with spontaneous rescuers or convergent volunteers with sensitivity.

#### COLLAPSE/HAZARD ZONE

To control all access to the immediate area of the collapse that could be impacted by secondary collapse and falling debris. Only rescue personnel directly involved in search and extrication operations are allowed in this zone.



#### OPERATIONAL WORK AREA

To control the access to the rescue work site except for assigned emergency personnel supporting the operation.

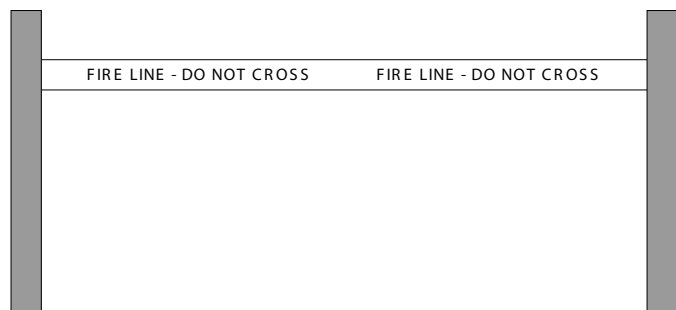


Figure 1:20 Rescue work site set up



# RESCUE SYSTEMS 1

## Basic Rescue Skills

### Topic 1-4: US&R Planning and Preparation



In order to assist with control of the site and in order to identify the area of concern, a physical barrier should be established around the entire site. This could be a large area depending on the physical layout and impact of the incident.

When using barrier tape, a single piece placed straight across the access indicates a controlled access area (crowd control more than a specific hazard) and crossing the tape indicates a specific hazard area and do not enter. Other possible methods to control the scene are fencing, temporary chain-link or plastic construction mesh, pylons, and barricades. In most cases, police agencies or public works departments can assist in acquiring the necessary materials.

Other useful resources in controlling the site are the police and the military. These agencies are established and have standard procedures for controlling specific areas. These resources and their actions must be coordinated with the IC.

#### ***Control Access***

Access must be controlled through entrance and exit points to allow for personnel accountability and control.

#### ***Establish Best Access Route to the Incident***

The IC must communicate the best access to the site for incoming resources. This allows an organized approach to the scene, taking into consideration access conditions and anticipated need and use of resources.

#### ***Establish the Incident Command Post***

The location of the Incident Command Post or CP is an important part of the initial incident setup. The CP must be located away from the hazard area. The IC should not have to deal with potential hazards and should not be placed in a hazardous position. The location of the CP must be communicated to resources and the communication center.

The CP should provide shelter from weather and privacy as needed. Access to the CP should be limited to allow control of the area and to decrease the potential for large numbers of personnel to gather there. Security should be provided as needed. The CP should be located away from noisy operations and should not be crowded with unnecessary personnel or resources.

#### ***Establish a Staging Area***

The IC should establish and identify a staging area for incoming resources. This site should be away from the immediate scene, but provide reasonable access to it. The staging area should be large enough to handle the anticipated volume of first-to-arrive, immediate-need resources. Resources assigned to staging should keep in communication with the IC or Operations Section Chief at the incident site and be ready to respond to an assignment within three minutes. The chosen site should minimize disruptions of other activities, including the normal flow of traffic, if possible.

The IC should establish and identify the location of a base for planned-need resources that will arrive later. A base is usually established when the mitigation of the incident will probably take longer than one 12-hour operational period. Considerations in the selection of a long-term staging area or base should include sanitary facilities, food and drink, and shelter.



# RESCUE SYSTEMS 1

## Basic Rescue Skills

### Topic 1-4: US&R Planning and Preparation



#### ***Control the Site to Decrease Freelancing***

Controlling the access and egress ensures that the use of resources, which includes personnel, is documented. Controlled access improves safety by limiting the number of personnel within the danger area. It also ensures accountability, as each person or resource is checked in and out through staging and to the IC, Operations Section Chief, Branch Director, or Division/Group Supervisor.

#### **Resources**

##### **National Fire Protection Association**

National Fire Protection Association (NFPA) standards cannot be considered as mandated unless legally adopted by an agency. They can and should be considered as a common practice and benchmark within the industry.

##### ***NFPA 1006 - Standard for Rescue Technician Professional Qualifications***

Establishes the minimum job performance requirements necessary for the fire service and other emergency response personnel who perform technical rescue operations.

- Rope rescue
- Surface water rescue
- Vehicle and machinery rescue
- Confined space
- Structural collapse
- Trench rescue

##### ***NFPA 1500 – Fire Department Occupational Safety and Health Program***

Contains minimum requirements for a fire service–related occupational safety and health program. Applicable to public, governmental, military, private, and industrial fire department organizations providing rescue, fire suppression, emergency medical services, hazardous materials and mitigation, special operations, and other emergency services.

##### ***NFPA 1670 – Standard on Operations and Training for Technical Rescue Incidents***

Identifies and establishes levels of functional capability for safely and effectively conducting operations at a technical rescue incident to the awareness, operations, and technical levels.

Applicable to organizations that provide response to technical rescue incidents.

- Structural collapse
- Water rescue (dive, ice, surf, swift water)
- Rope rescue
- Confined space
- Vehicle and machinery
- Wilderness
- Trench and excavation



# RESCUE SYSTEMS 1

## Basic Rescue Skills

### Topic 1-4: US&R Planning and Preparation



#### ***NFPA 1983 – Standard on Fire Service Life Safety Rope and System Components***

Specifies minimum performance criteria, design criteria, and test methods for new life safety rope and new system components.

- Personal escape rope
- Life safety harness
- Belts
- Auxiliary equipment used for rescue and training by the fire service or similar emergency service organizations

#### **American National Standards Institute (ANSI) Standards of Practice**

- ANSI Z87.1 - Standard for eye and facial protection
- ANSI Z89.1 - Standard for protective head wear

#### **Occupational Standards and Health Administration (OSHA)**

Both California and the federal government have OSHA-related branches with associated field offices. OSHA should be considered a safety practices monitoring and enforcement agency.

OSHA has both fined and assigned punitive damages in cases where violations have occurred.

- OSHA 29 CFR 1910.10 Blood Borne Pathogen
- OSHA 29 CFR 1910.120 Hazardous Materials Technical Standards
- OSHA 29 CFR 1910.130 Eye and Face Protection
- OSHA 29 CFR 1910.134 Standard for Firefighting Related to Two In and Two Out
- OSHA 29 CFR 1910.134 Standard on Respiratory Protection
- OSHA 29 CFR 1910.135 Standard on Head Protection
- OSHA 29 CFR 1910.136 Standard on Foot Protection
- OSHA 29 CFR 1910.138 Standard on Hand Protection
- OSHA 29 CFR 1910.146 Permit Required Confined Space
- OSHA 29 CFR 1910.147 The Control of Hazardous Energy (Lockout/Tagout)
- OSHA 29 CFR 1910.5 Fall Protection, Escape and Rescue Standards
- OSHA 29 CFR 1910.95 Noise Exposure Standard
- OSHA 29 CFR 1926.652 Excavations

#### **California Code of Regulations (CCR)**

Affects all California governmental agencies as of December 1, 1996. Requires SEMS training and use in order to be eligible for state funding of emergency response–related costs.

#### ***Code Section 8607***

Standardized Emergency Management System (SEMS)





---

# RESCUE SYSTEMS 1

## Basic Rescue Skills

---



## Topic 2-1: Rescue Knots and Hitches

**Terminal Objective:** The student will be able to identify and properly tie all Rescue Knots and Hitches.

**Enabling Objectives:**

1. Demonstrate learned knowledge, skills, and abilities from prerequisite Low Angle Rope Rescue Operational Operational (LARRO) course.
2. Demonstrate how to tie the six required knots.
3. Demonstrate how to tie the four RSI required knots.

The Low Angle Rope Rescue Operational (LARRO) course provided detailed information to the student related to knots and hitches. Students learned rope terminology, components of knots, and how to tie the following six knots and hitches. The student will be asked to demonstrate how to tie each of these knots.



Figure 2:1 Figure Eight Stopper

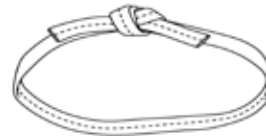


Figure 2:4 Overhand Bend



Figure 2:2 Figure Eight on a Bight

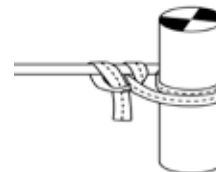


Figure 2:5 Round Turn with Two Half Hitches



Figure 2:3 Overhand Knot



Figure 2:6 Three Wrap Prusik Hitch

Building from the skills learned in LARR, the student will be instructed on how to tie four additional knots/hitches: the Figure Eight Follow Through, Figure Eight Bend, Double Overhand Bend, and the Clove Hitch. Two optional knots/hitches, the Double Overhand on a Bight and the Tensionless Hitch, are not required to accomplish the objectives in this course, but may enhance the rescuer's capabilities in the field.

## Required

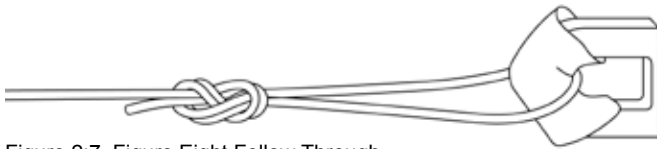


Figure 2:7 Figure Eight Follow Through



Figure 2:10 Double Overhand Bend



Figure 2:8 Figure Eight Bend

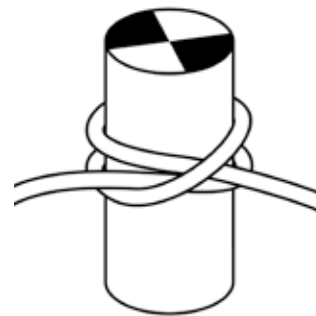


Figure 2:11 Clove Hitch

## Optional



Figure 2:9 Double Overhand on a Bight

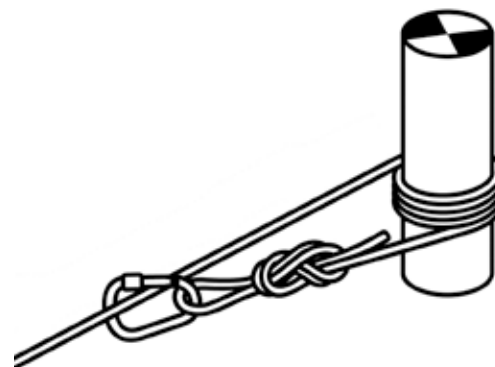


Figure 2:12 Tensionless Hitch

## 1. Figure Eight Follow Through

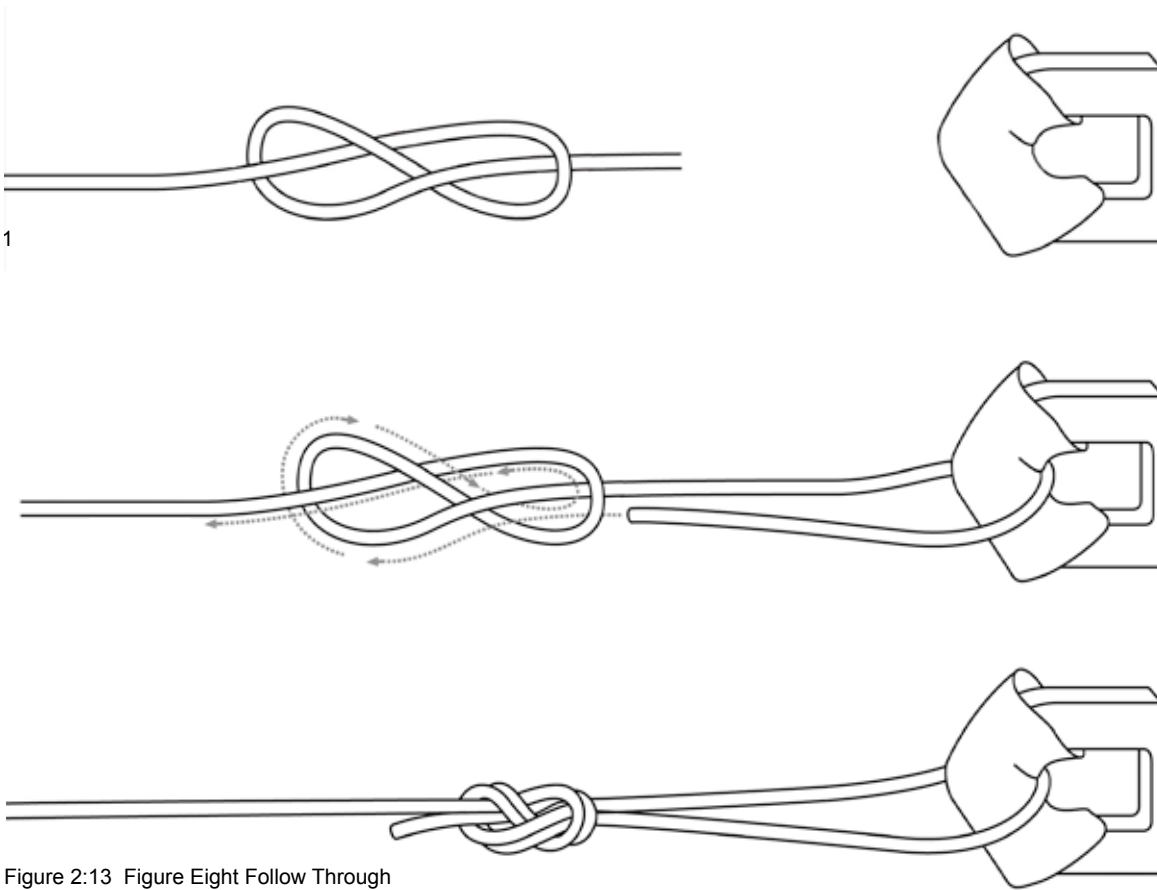


Figure 2:13 Figure Eight Follow Through

### Use

- Secure lifeline around an object.
- Secure lifeline through a “trussed” anchor such as a closed tow hook on a fire engine.

### Specifics

- 6" tail (minimum).
- Chaffing protection may be needed.
- Difficult to untie after loading.
- Dressed and set.

## 2. Figure Eight Bend

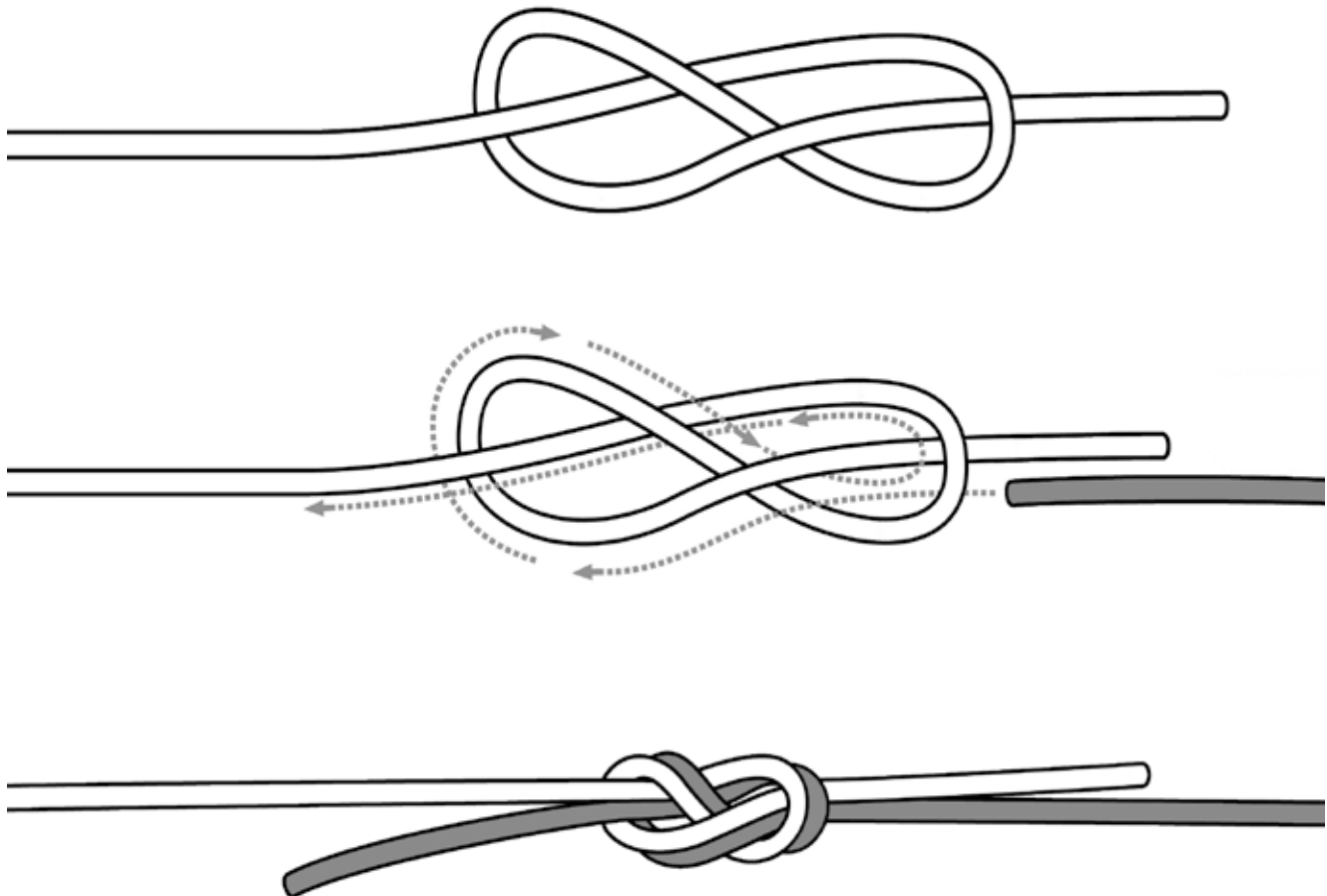


Figure 2:14 Figure Eight Bend

### Use

- Join two lifelines of the same diameter together.
- Tie one length of lifeline into a loop to form a sling.

### Specifics

- 6" tail (minimum).
- Difficult to untie after loading.
- Dressed and set.

## 3. Double Overhand Bend

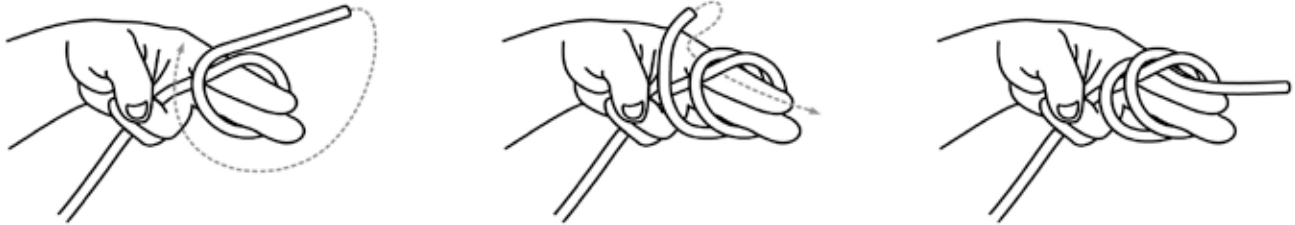


Figure 2:15 Double Overhand Bend

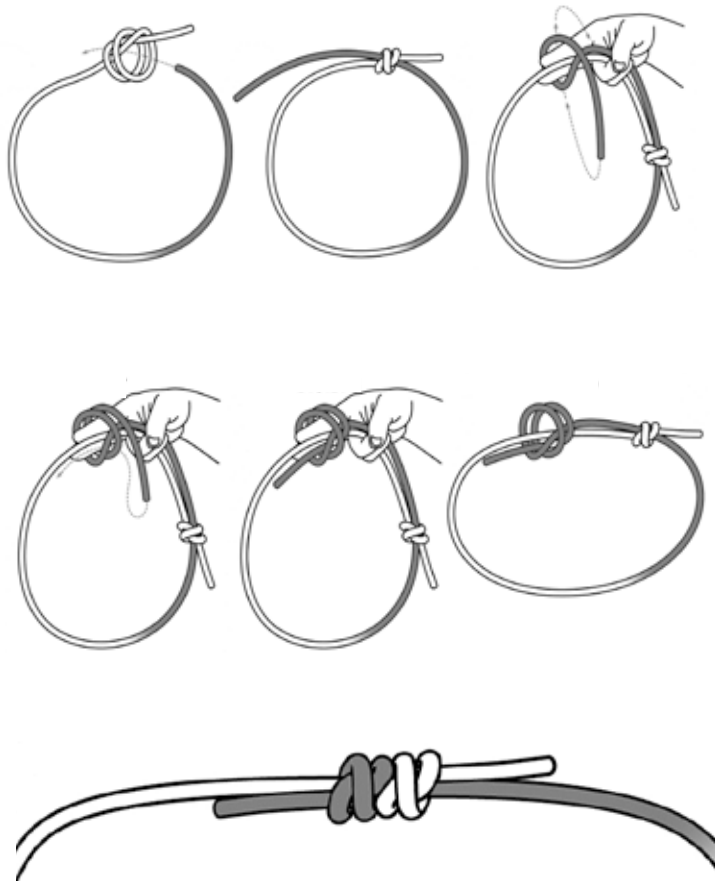


Figure 2:16 Double Overhand Bend

### Use

- Tie two equal-diameter rope ends together.
- Preferred knot for forming:
  - Prusik loops
  - Rope anchor slings
  - Rope litter attachment
  - Union of two equal diameter lifelines

### Specifics

- 1" tails (minimum).
- When tied correctly, the tail of each rope should end up on the side of the knot opposite the side it entered.
- The two turns from each half of the knot should lie flat against one another on one face of the knot and appear as a double X on the other side.
- Difficult to untie once loaded. It is for this reason that, once tied, prusik loops are not generally untied until damaged or retired.
- Dressed and set.

## 4. Double Overhand Bend

*Method 1: Slid over the Open End of an Anchor*

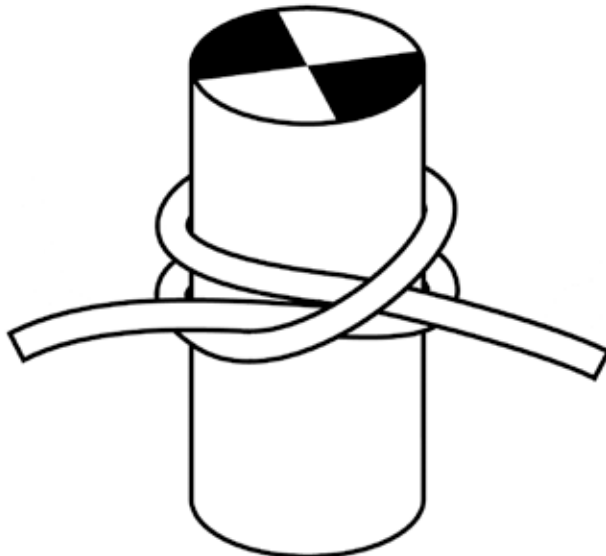
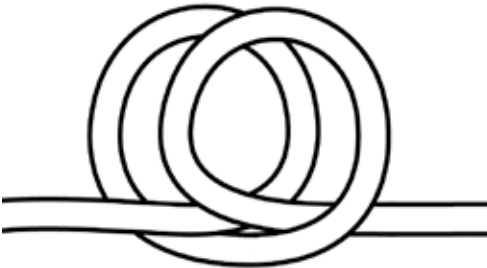
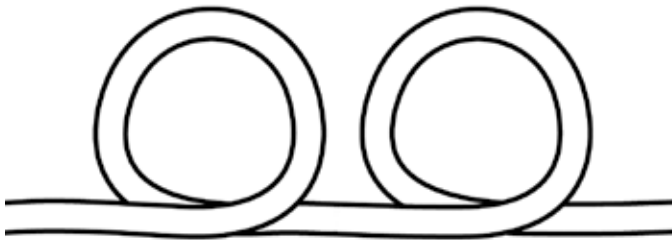


Figure 2:17 Double Overhand Bend  
Method 1: Slid over the Open End of an Anchor

### Use

- Secure webbing or lifeline to a round, nontrussed anchor.
  - Picket
  - Bollard
- Use when the hitch can be slipped over one end of an anchor.

### Specifics

- 4" tail (minimum).
- Ends must be secured.
  - Overhand knot
  - Two half hitches
- Dressed and set.

## *Method 2: Tied Around a Trussed (Closed) Anchor*

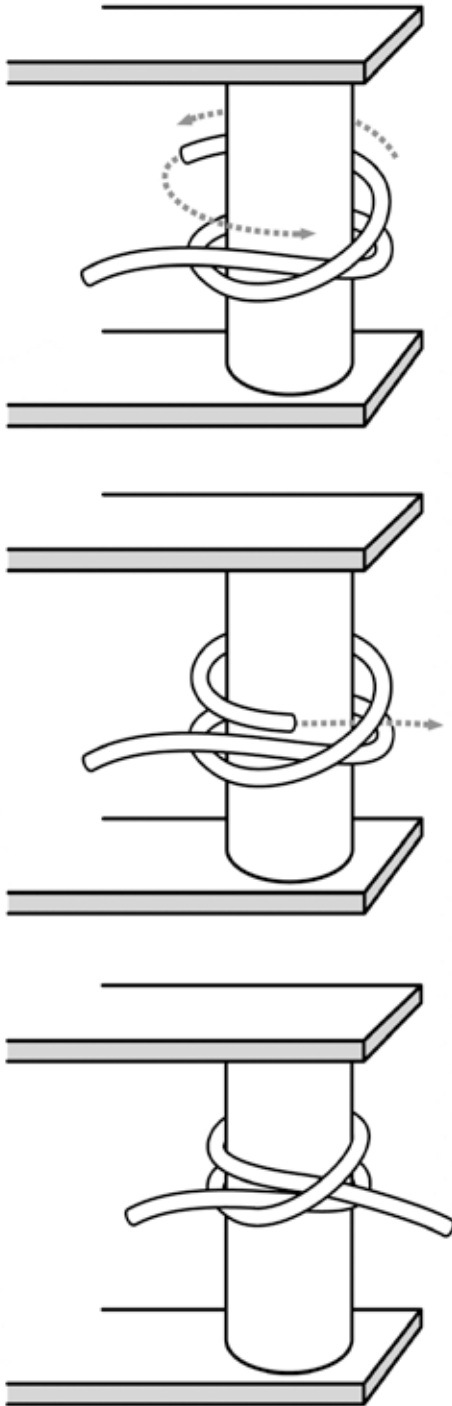


Figure 2:18 Double Overhand Bend  
Method 2: Tied Around a Trussed (Closed) Anchor

### Use

- Secure webbing or lifeline to a round, trussed anchor.
  - Litter rail
  - Ladder rung
  - Tree
- Use when the hitch **cannot** be slipped over one end of an object.

### Specifics

- 4" tail (minimum).
- Ends must be secured.
  - Overhand knot
  - Two half hitches
- Dressed and set.



## 5. Double Overhand on a Bight (Optional)

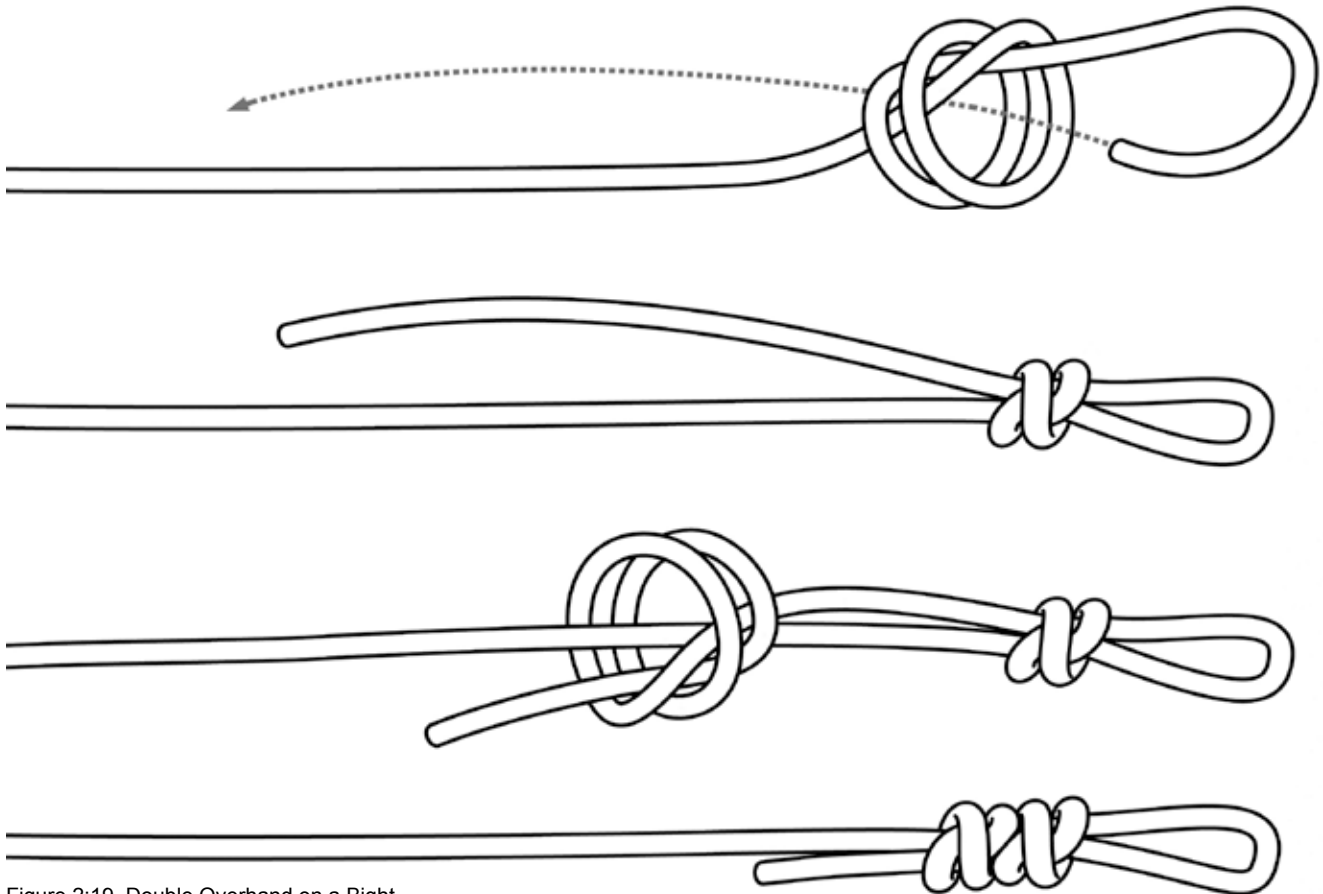


Figure 2:19 Double Overhand on a Bight

### Use

- Provide permanent bight or loop at the end of a rope or lifeline.
- Commonly used to replace the Figure Eight on a Bight at the ends of prerigs.

### Specifics

- 2" tail minimum.
- Once loaded, will not come undone.
- Very difficult to untie.
- Dressed and set.

## 6. Tensionless Hitch (Optional)

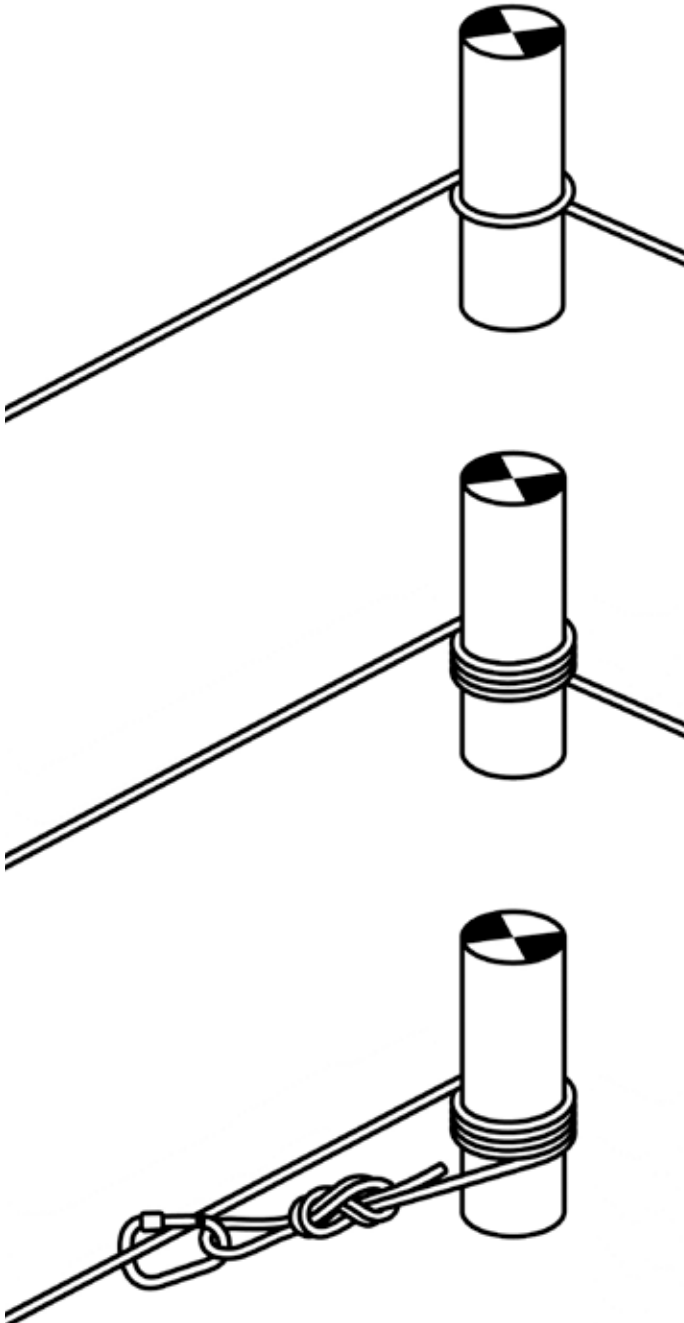


Figure 2:20 Tensionless Hitch

### Use

- Simple method to anchor a rope to a round anchor point.

### Specifics

- Derives its name from the fact that the standing end of the lifeline does not have any tension in it when the working end is pulled on.
- Can preserve up to 100 percent of the strength of the lifeline.
- The number of wraps depends on the smoothness of the anchor.
  - The smoother the surface, the more wraps that will be needed.
  - Use between four and six wraps.
- Using a round anchor less than 4" in diameter will result in a reduction in the strength of the lifeline.
- The lifeline is tied to the standing end of the lifeline as a safety measure using an overhand knot or secured with a carabiner.
- While this is an extremely strong way to anchor a lifeline, it can use a significant portion of the length of lifeline. This shortening of available lifeline length must be considered before this anchor is used in a system.
- Dressed and set.



---

# RESCUE SYSTEMS 1

## Basic Rescue Skills

---





# RESCUE SYSTEMS 1

## Basic Rescue Skills

### Topic 2-2: Anchor Systems



## Topic 2-2: Anchor Systems

**Scope:** This chapter serves as a review of Anchor Systems learned in the prerequisite Low Angle Rope Rescue Operational course.

**Terminal Learning Objective (TLO):** At the end of this chapter, the student will be aware of anchor selection and anchor system construction required for Rescue Systems 1 skills.

**Enabling Learning Objectives (ELO):**

1. Describe considerations when selecting anchors.
2. Describe the types of anchors.
3. Demonstrate how to form a single loop, double loop, locking girth hitch (lark's foot).
4. Demonstrate how to form a single and double loop basket sling (three bight).
5. Demonstrate how to form a single and multiloop anchor sling.
6. Demonstrate how to form a wrap three pull two anchor sling.
7. Demonstrate sling anchor attachments: pretied.
8. Demonstrate single sling anchor attachments: open.

The Low Angle Rope Rescue Operational (LARRO) course provided detailed information related to natural and mechanical anchor systems in the low-angle rescue environment. Students will be asked to demonstrate these previously learned skills prior to applying them in this course. In Rescue Systems 1, students are introduced to the application of these anchor systems in a **structural environment**. The anchor slings depicted may be used interchangeably throughout the course; however, their use and application differ from site to site depending on anchor configuration. It is imperative that rescuers remain acquainted with each of these anchor slings/systems so, when they are presented with a real-world scenario, they can recall the appropriate anchor sling/system for the situation. Each anchor sling/system is described by its common name and its capacity based on whether it is formed with lifeline or webbing. The capacity will be described as either "General Use," which is intended for all-purpose system attachments, or "Light Use," which is reserved for nonrescue loads such as a fall restraint for a person working near an edge. These terms are based on NFPA 1983: Standard on Life Safety Rope and Equipment for Emergency Services (2006) standards for minimum breaking strengths for manufactured components used in rope rescue. Under no circumstances do these terms guarantee the integrity of a rope rescue system. The integrity is based on sound decision making when selecting anchors, as well as proper selection and configuration of the anchor slings.

## Single Point Anchor Slings

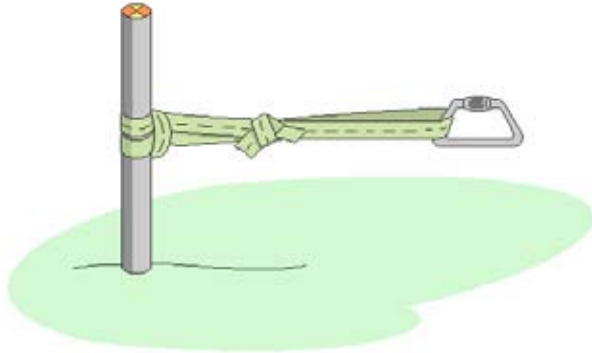


Figure 2:21 Girth Hitch  
Lifeline: General Use / Webbing: Light Use

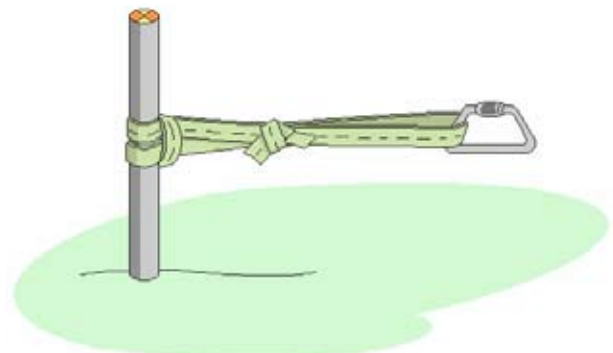


Figure 2:22 : Double Loop Girth Hitch  
Lifeline: General Use / Webbing: General Use

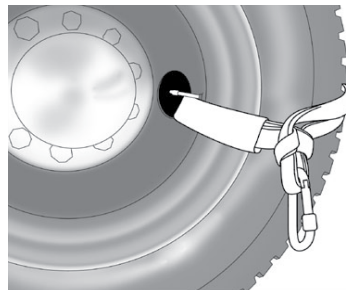


Figure 2:23 : Locking Girth Hitch  
Lifeline: General Use  
Webbing (Single Loop): Light Use  
Webbing (Double Loop): General Use

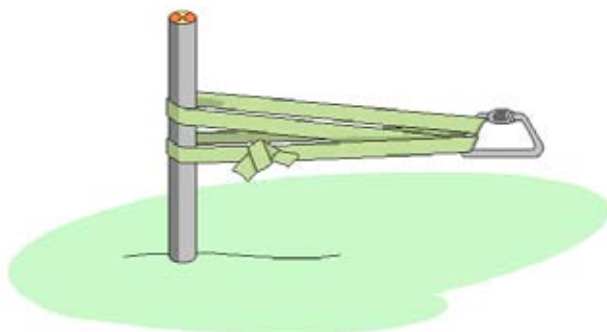


Figure 2:24 : Basket Sling  
Lifeline: General Use / Webbing: General Use

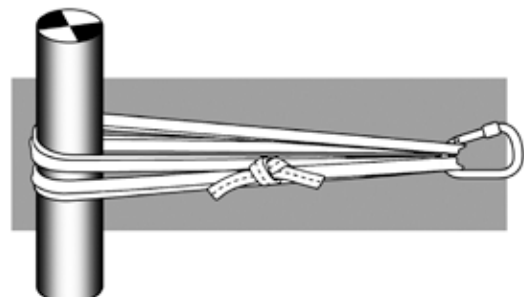


Figure 2:25 : Double Loop Basket Sling  
Lifeline: General Use / Webbing: General Use

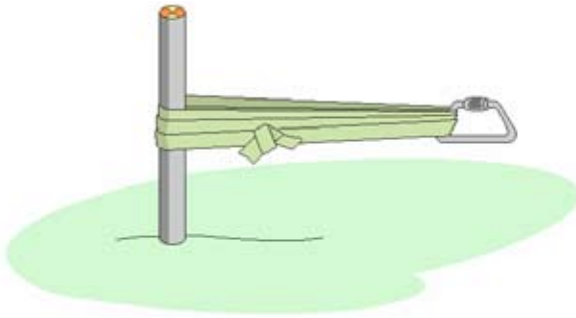


Figure 2:26 : Multiloop  
Lifeline: General Use / Webbing: General Use

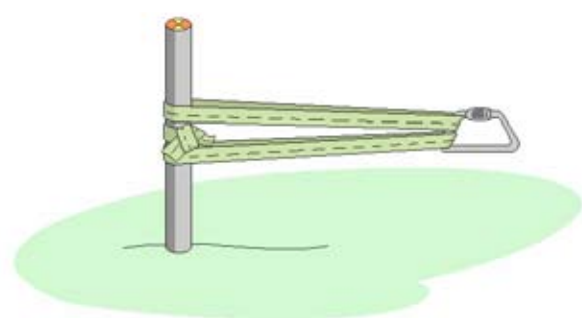


Figure 2:27 : Wrap three pull two  
Lifeline: General Use / Webbing: General Use

## **Multipoint Anchor Slings**

Situations will arise when a single anchor is not located directly in line with the point of departure. Understanding how to construct multiple-point anchor systems allows the rescuer to combine two anchors into one central anchoring point. The two- and three-point self-adjusting anchor systems learned in LARR may still be used, but **the rescuer must be cautioned to the fact that, if either one of the anchors were to fail, the other would likely follow suit** due to the shock load caused by the carabiner traveling to the limit of the adjusting sling.

Another solution to the situation of multiple anchors but none of them in line with the point of departure is the “focused” anchor sling. The focused anchor sling can be very useful to rescuers operating in structures that were not designed to have rope systems anchored to them as is typical outside the training environment.

**In all multipoint anchor systems the rescuer must keep in mind that if any of the single anchors is inadequate to support the estimated load, failure of any of these single anchors in the multiple system will create a shock load to the remaining system, greater in some than others. The resulting force will most likely cause failure to the entire system.**

**When in doubt, tag out**, meaning that, if there are no apparent suitable anchors, they can usually be created by tagging out the anchor system in the opposite direction, even if you have to tag out of the structure down to your apparatus parked in the street.

## **Two-Point Focused Anchor Sling**

1. Form a sling out of an adequate length of rope by tying a Double Overhand Bend. Rope is preferred over webbing to provide the necessary length so as not to create a critical angle and it is easier to untie after being loaded.
2. Wrap the anchors with the sling and pull the center point of the strands toward the desired direction forming two bights.
3. Tie the bights into a doubled Overhand on a Bight. Both bights should be similar in size when finished.
4. Attach a carabiner to the bights. Caution: Whenever more than one strand of rope is attached to the same end of a loaded carabiner, it reduces the strength of the carabiner below its rated capacity. If the full capacity of the carabiner is needed, two carabiners should be used, one on each bight. (see Figure 2:27 )



Figure 2:28

## Anchor Slings/Systems Applied in a Structural Environment

Any one or combination of these anchor slings or systems may be used in the structural environment to affect a rope rescue. Care must be taken when applying slings around large single-point anchors or multiple anchors that are not located near each other. Critical angles will cause a loss in strength in anchors, slings, or carabiners, depending on the configuration.

An anchor sling with a  $160^\circ$  angle causes a severe crushing force if wrapped around a single anchor or a severe pulling force if applied to a multipoint anchor system. If the severe forces do not cause the anchor itself to fail, they may cause the sling to fail due to the extreme forces of tension. (See Figures 2:29, and 2:30)

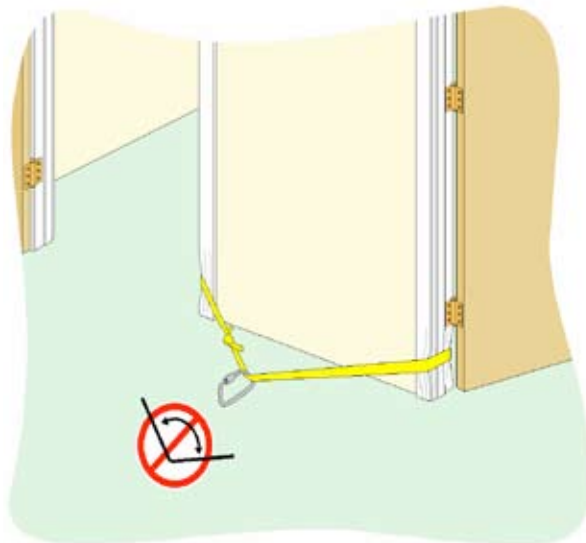


Figure 2:29

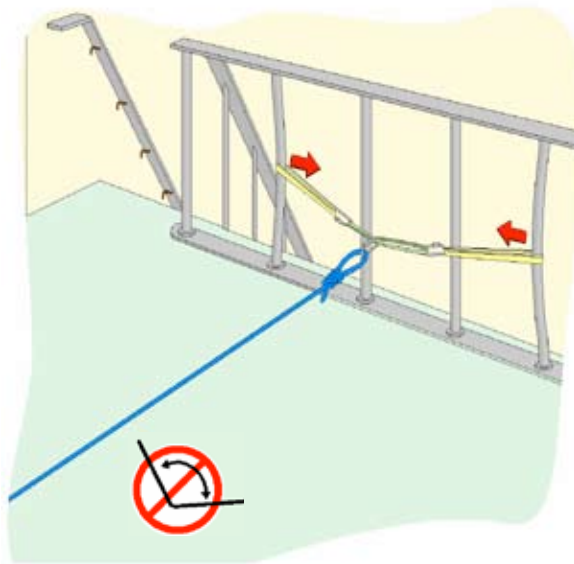
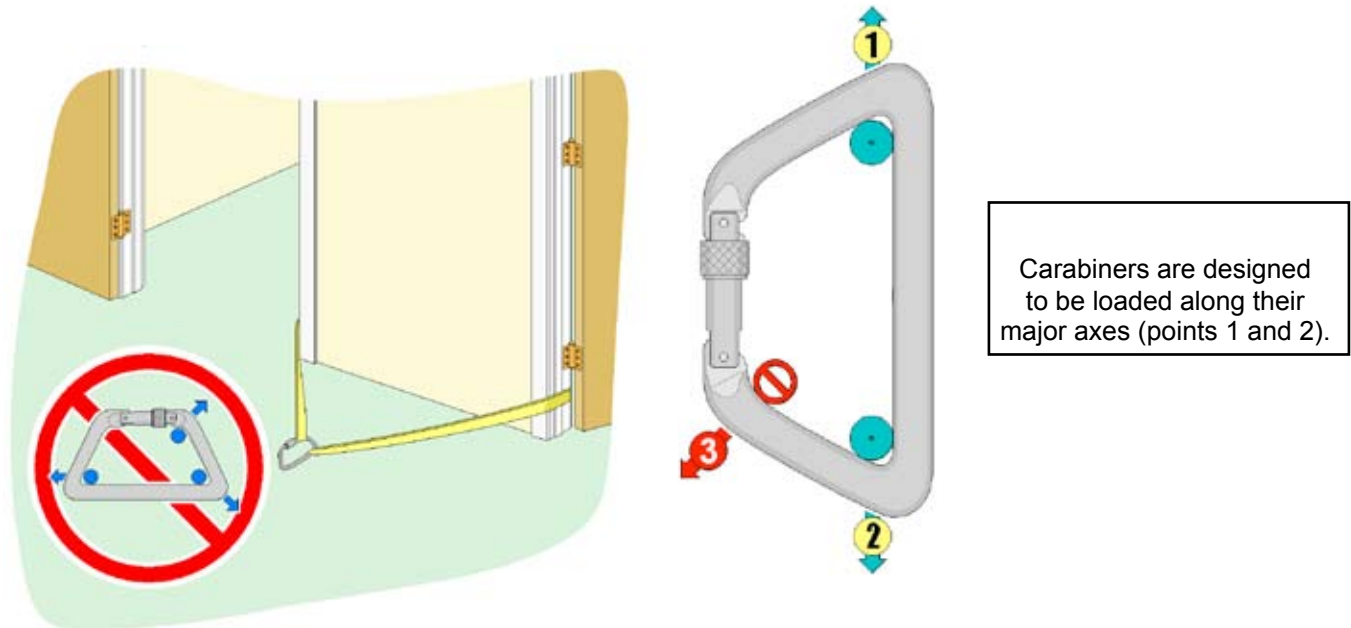


Figure 2:30



Another critical angle factor that can create a more catastrophic failure is when the anchor sling itself loads the carabiner in a way that it was not designed to handle.

This is referred to as tri-loading the carabiner, which significantly reduces its strength, in some cases up to a 60 percent loss of strength.



Carabiners are designed to be loaded along their major axes (points 1 and 2).

Figure 2:31



A General Use carabiner that was inadvertently tri-loaded during a slow pull test of an anchor sling. The failure occurred far below the rated capacity of the carabiner.

Figure 2:32

## Considerations When Selecting Anchors

When selecting an anchor several factors must be considered:

- How much force will the anchor need to be able to hold?
- What direction will the pull or force come from?
  - A “nondirectional anchor” will withstand a pull from any direction.
  - A “directional anchor” will fail if the load shifts to an unintended direction of pull.
- What is the location of available anchors?
  - Is there an adequate and safe working distance between the anchor, anchor system, and edge? Remember to provide enough space for the litter basket, if required.
  - Is the anchor in line with the point of departure? **If not, a tagged anchor or a focused anchor may be required.**
- Does the anchor need to be padded to protect the anchor sling material from sharp edges, excessive heat, or caustic materials?

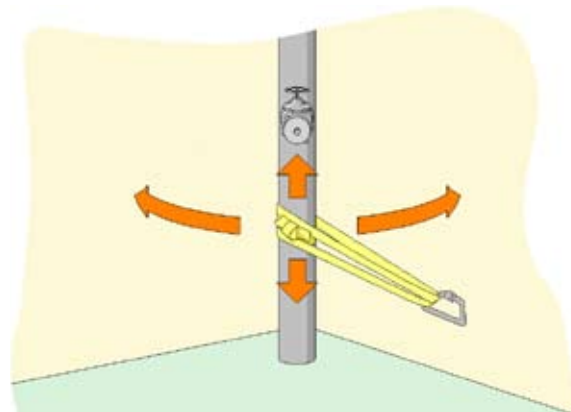


Figure 2:33 Nondirectional Anchor

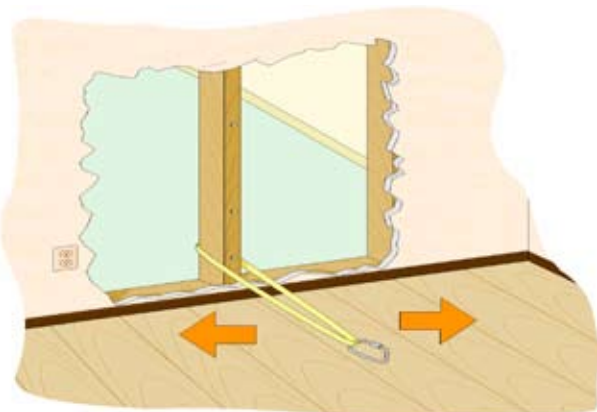


Figure 2:34 Nondirectional Anchor  
(However will slide up and down with some sling configurations.)

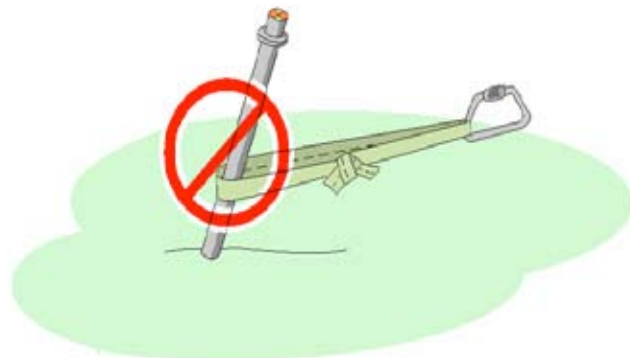


Figure 2:35 Directional Anchor with incorrect direction of pull

## Types of Anchors

### Structural Components

- Use major structural components.

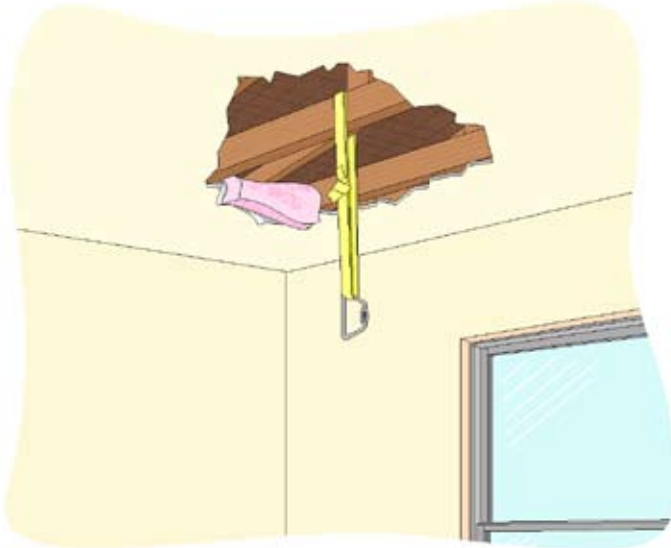


Figure 2:36 Multiloop around a ceiling joist.

- Use well-established anchors on large machinery and equipment.



Figure 2:37 Multiloop Sling around a weight machine.

- Inspect potential anchors for rust, corrosion, weathering, and quality of installation.



Figure 2:38 Wrap Three Pull Two Sling around a rusty railing.

- Consider spanning windows and door openings to create anchors.

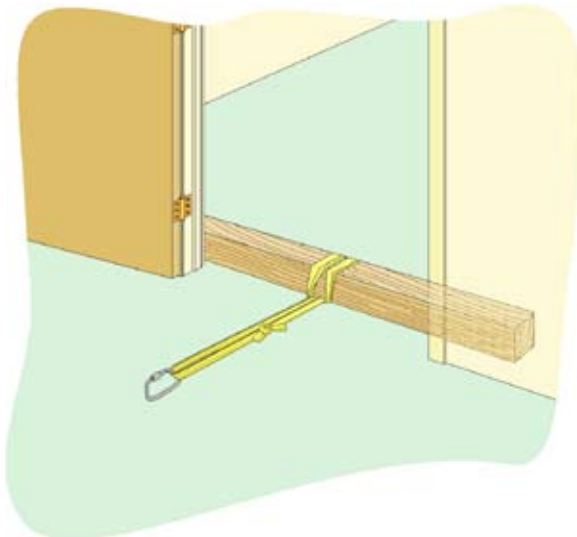


Figure 2:39

### Others

There are several types of manufactured anchors that will not be covered in this class. An example is the installation of large and permanent anchor bolts in holes drilled in concrete during heavy rescue operations. This requires specialized pieces of equipment and additional training. This course will deal with anchor options that are more common to most structural high-angle rescue operations.



---

# RESCUE SYSTEMS 1

## Basic Rescue Skills

---

### Topic 2-2: Anchor Systems

---



## **Anchor Strength Requirements**

### **California Code of Regulations, Title 8, Section 1670 Personal Fall Protection**

This standard requires that anchors be capable of supporting at least 5,000 pounds per employee attached **or** must be designed, installed, and used as part of a complete fall arrest system that maintains a safety factor of at least two and is used under the supervision of a qualified person.

The systems described in this manual have been tested and found to exceed the 5,000 pound benchmark in the standard. However, the user is responsible for ensuring that all components of the system used are strong enough for their application.



# RESCUE SYSTEMS 1

## Basic Rescue Skills



### Topic 2-3: Rescuer and Ambulatory Victim Packaging

## Topic 2-3: Rescuer and Ambulatory Victim Packaging

**Scope:** This chapter serves as a review of Rescuer and Ambulatory Victim Packaging learned in the prerequisite Low Angle Rope Rescue Operational (LARRO) course and will introduce and provide instruction on additional knowledge and skills that may be required for Rescue Systems 1 skills.

**Terminal Learning Objective (TLO) identified in LARR:** At the end of this chapter, the student will be aware of how to properly package rescuers and victims to safely and effectively complete a rope rescue operation.

**Enabling Learning Objectives (ELO) identified in LARR:**

1. Describe rescue harnesses and rescuer packaging.
2. Demonstrate how to don a Class III harness.
3. Demonstrate how to package a victim in a commercial victim harness.
4. Demonstrate how to package a victim in a Hasty Pelvic harness.

The Low Angle Rope Rescue Operational (LARRO) course provided detailed information to the student related to Rescuer and Ambulatory Victim Packaging. The student will be asked to demonstrate these learned skills.

Proper packaging of rescuers and victims is essential to a safe and effective rope rescue operation. It is imperative that all rescuers have the knowledge, skills, and ability to efficiently and effectively place a harness on themselves as well as an ambulatory victim.

## Rescuer Packaging



Figure 2:40 Class III Harness

There are several commercially manufactured rescue harnesses available. The minimum standard for this course is NFPA 1983 Class III harnesses. Harnesses are required for all rescuers that are suspended by the rope rescue system as well as those positioned within 10' of an unprotected edge.

- Package rescuers per manufacturer's specifications.
- Proper fit of harnesses on students/rescuers must be ensured by qualified instructor.

### **Refer to Appendix C for a Sample NFPA Class III Harness Instruction Card**

The instructor shall provide each student with a copy of the instruction card for the exact harness(es) provided during this course if different than the sample included in this text.

## **Ambulatory Victim Packaging Overview**

Rope rescues will often involve victims who do not need to be removed from a hazardous environment in a rescue litter. In these situations, the rescuer must be able to quickly and effectively secure the victim with a harness and into the rope rescue system. Once victims are secured to the system, they can be raised or lowered to a safe environment. Rescuers have historically performed this task with a Hasty harness tied out of webbing. In recent years, commercial victim pelvic harnesses have become available and are now the preferred method for packaging ambulatory victims, if available.

## **Ambulatory Victim Packaging**

### **Method 1: Commercial Victim Pelvic and Chest Harness**

There are a variety of commercially manufactured victim pelvic harnesses on the market. All models attach quickly and securely around the waist and thighs or under buttocks no matter where or how the victim is positioned. The added chest harness component turns the pelvic harness into a full-body evacuation harness for vertical lifts. The design of this evacuation harness allows it to be put on without the victim having to step into the harness.

Package victim per manufacturer's specifications.

### **Refer to Appendix D for a Commercial Victim Harness Instruction Card**

The instructor shall provide each student with a copy of the instruction card for the exact harness(es) provided during this course if different than the sample included in this text.



Figure 2:41 Commercial Victim Harness



## Method 2: The Hasty Pelvic and Chest Harness (Improved Harness)

In some cases there may be a need to secure a victim to a rope rescue system without the availability of a commercial victim harness. Of course, if commercial rescuer harnesses are available they should be considered prior to an improvised harness as long as donning the harness does not compromise the victim's positioning by having to step through. When relying on an improvised harness in a high-angle rescue environment, it is necessary to protect the victim from inverting and falling out of the harness. In RS1 we will be using the Hasty Pelvic harness in conjunction with the Hasty Chest harness in order to maintain the stability of the ambulatory victim. The skills required to form the Hasty Pelvic harness were learned in LARR. The Hasty Pelvic harness requires a 12' or 15' piece of webbing, depending on the size of the victim. (See Figure 2:42.) The skills required to form the Hasty Chest harness will be described in the steps below.



Figure 2:42

## Hasty Chest Harness

1. Tie a 12' or 15' piece of webbing, depending on the size of the victim, into a sling using an Overhand Bend.



Figure 2:43

2. Place the knot between the victim's shoulder blades, then wrap the sling around the victim's sides to the front forming a bight in each hand.



Figure 2:44

3. Have the victim place one arm through the bight and the other arm over the opposite bight.



Figure 2:45

4. Pass one bight through the other, then pass the other one through it forming a Locking Girth Hitch.



Figure 2:46



Figure 2:47

5. Cinch until snug, keeping the sling just under the armpits. Caution: Ensure the sling is not permitted to become slack or it will droop too low, which may cause internal injuries by squeezing the lower ribs if the victim is subject to a shock load while suspended in the harness.



Figure 2:48

6. Secure with two Half Hitches.



Figure 2:49



Figure 2:50

7. Attach carabiner to the bight, then clip it to the single strand, bighting down and flipping up.



Figure 2:51



Figure 2:52

\* Students must be able to form this harness on themselves as well as a victim.



---

# RESCUE SYSTEMS 1

## Basic Rescue Skills

---



### Topic 2-3: Rescuer and Ambulatory Victim Packaging

---

**ATTENTION: Cal-OSHA regulation prohibits the use of improvised harnesses in lieu of commercial rescue or victim harnesses except when necessary to save a life.**

**This means students are not to use this harness while being suspended in a rope rescue system during training.**



# RESCUE SYSTEMS 1

## Basic Rescue Skills



### Topic 2-4: Rescuer and Ambulatory Victim Packaging

## Topic 2-4: System Attachments and Fall Restraint

**Scope:** This chapter serves as a review of System Attachments and Fall Restraint learned in the prerequisite Low Angle Rope Rescue Operational (LARRO) course and will introduce and provide instruction on additional fall restraint knowledge and skills that may be required for Rescue Systems 1 skills.

**Terminal Learning Objective (TLO):** At the end of this chapter, the student will be aware of several methods of system attachments for rescuers and victims.

**Enabling Learning Objectives (ELO):**

1. Describe system attachments.
2. Demonstrate how to attach a rescuer to a rope rescue system.
3. Demonstrate how to attach an ambulatory victim to a rope rescue system.
4. Demonstrate how to attach a rescue litter vertically to a rope rescue system.
5. Demonstrate how to attach a rescue litter horizontally to a rope rescue system.
6. Demonstrate how to tend a rescue litter.
7. Demonstrate how to attach a rescuer to a fall restraint system.

The Low Angle Rope Rescue Operational (LARRO) course provided detailed information to the student related to system attachments and fall restraint with Class II harnesses and litters in a Low Angle Rope Rescue Operational environment. The student will be asked to demonstrate these learned skills and then will be taught how to adapt these attachments to a Class III harness and litters in a high-angle rope rescue environment.

This chapter describes several methods of system attachments for rescuers and victims. The systems addressed are:

- Rescuer attachment to a rope rescue system
- Ambulatory victim attachment to a rope rescue system
- Litter attachment to a rope rescue system
- Litter harness (prerig) attachments to a rescue system—horizontal configuration
- Litter tending with guy lines
- Rescuer attachment to fall restraint systems

## Rescuer Attachment to a Rope Rescue System

In most high-angle operations, the main line is attached to the rescuer's harness at the waist D-ring. The belay/safety line is primarily attached to the dorsal D-ring (ring located on back between shoulder blades). In some circumstances this connection is not preferred. An alternative connection for the belay/safety line is at the chest D-ring.



Figure 2:53 Dorsal Belay/Safety line attachment



Figure 2:54 Main line attachment



Figure 2:55 Main line with chest Belay/Safety line attachment

### Specifics

- NFPA Class III harness
- Main line attached to front waist D-ring with NFPA General-rated carabiner
- Belay/safety line attached to dorsal D-ring with NFPA General-rated carabiner

Note: Some harness manufacturers suggest that these attachments be made with a self-locking carabiner or snap link.

## Advantages

- ❑ Main line attachment at front waist D-ring allows for excellent mobility and enables the rescuer to maintain a seated position whether fully suspended or with feet planted on a wall. This position prevents the occurrence of suspension syndrome, which is caused by being suspended in a harness (deliberate or accidental) in a standing position, where blood pools in the legs. This leads to unconsciousness or, if allowed to develop unchecked, it will be fatal.
- ❑ Belay/safety line attachment at the dorsal D-ring allows the harness to distribute the energy throughout the body when the belay/safety line arrests a fall due to main line failure.
- ❑ Belay/safety line attachment at the chest D-ring allows victims to be connected to the belay/safety system without compromising its effectiveness for the rescuer during ambulatory victim retrievals.

## Disadvantages

- ❑ Main line attachment at front waist D-ring can make it difficult for the rescuer to access/egress through narrow openings.
- ❑ Belay/safety line attachment at the dorsal D-ring in some circumstances depending on the rescuer's position may cause the rescuer's head to thrust forward and hit a portion of the structure while arresting a fall during main line failure.
- ❑ Belay/safety line attachment at the chest D-ring will not distribute energy as well as the dorsal connection when the belay/safety system is arresting a fall during main line failure.

## Ambulatory Victim Attachment to a Rope Rescue System

It is common to encounter an ambulatory victim during rope rescue operations. The victim is packaged in either a commercial victim harness or an improvised harness from two pieces of webbing. The victim harness is best suited for quickly donning on a victim. Once the victim is packaged, he or she may be retrieved as a one-person load by connecting the ends of the main and belay/safety lines to the victim's harness. The other option is the two-person load by attaching the victim to the system with prusiks on the main and the belay/safety lines that remain connected to the rescuer. The longer prusiks are commonly used for this attachment. This victim will then be able to be positioned above, equal to, or slightly below the rescuer while being raised or lowered by the rope rescue system.



Figure 2:56



#### Specifics

- ❑ The preferred victim harness is commercially produced. If such a harness is not available, the Hasty harness may be used.



Figure 2:57  
Commercial victim harness attached to main and belay line with prusiks for victim and rescuer retrieval.



Figure 2:58  
Hasty harness with main line attached for victim only retrieval (belay/safety line omitted for clarity).



# RESCUE SYSTEMS 1

## Basic Rescue Skills



### Topic 2-4: Rescuer and Ambulatory Victim Packaging

## Victim Only Retrieval

### Commercial Victim Harness

1. The rescuer disconnects the main and belay/safety lines from the harness.
2. Attach the end of the main line to the main D-ring located near the sternum.
3. Attach the end of the belay/safety line to the main attachment D-ring with a second carabiner or with the one attached to the main line.

### Improvised (Hasty) Harness

1. The rescuer disconnects the main and belay/safety lines from the harness.
2. Attach the end of the main line to both the attachment pelvic and the chest harnesses.
3. Attach the end of the belay/safety line to both the pelvic and the chest harnesses with its own carabiners or the ones used for the main line.

## Advantages

- A single-person load is lighter and easier to raise.
- Rigging is much simpler.

## Disadvantages

- The rescuer is left unattended.
- More time is required to complete the rescue.

## Victim and Rescuer Retrieval

### Commercial Victim Harness

1. The rescuer remains connected to the main and belay/safety lines with the belay/safety line attached to the chest D-ring on the harness.
2. Attach a prusik to the main line above the rescuer's connection, then attach the other end of the prusik to the victim's main attachment D-ring located near the sternum.
3. Attach a prusik to the belay/safety line above the rescuer's connection, then attach the other end of the prusik to the victim's main attachment D-ring with a second carabiner or with attached to the main line.
4. Position the victim approximately equal in height to the rescuer so the rescuer can assist the travel of the victim.

### Improvised (Hasty) Harness

1. The rescuer remains connected the main and belay/safety lines with the belay/safety line attached to the chest D-ring on the harness.
2. Attach a prusik to the main line above the rescuer's connection, then attach the other end of the prusik to both the pelvic and the chest harnesses.
3. Attach a prusik to the belay/safety line above the rescuer's connection, then attach the other end of the prusik to both the pelvic and the chest harnesses with its own carabiners or with the same one same ones used for the main line prusik.
4. Position the victim approximately equal in height to the rescuer so the rescuer can assist the travel of the victim.

## Advantages

- Prusik attachments allow victims to be in varying positions from above to slightly below the rescuer, depending on situational needs.

## Disadvantages

- ❑ Once the victim is suspended, it is nearly impossible to adjust the victim's position.

## Rescue Litter Attachments to a Rope Rescue System—Vertical

Litters are attached to the ends of the main line and the belay/safety line with head lashings. These lashings are constructed of either a 5-foot section of webbing or an 8-foot section of lifeline or are lashed with the main and belay/safety lines themselves. Head lashings can be tied on scene or left preattached to the litter while in storage. These attachment methods are for the commonly used rescue litters.

Some agencies require an additional connection from the victim to the main or belay/safety or both lines as a backup. Although this is not required for completion of this course, some agencies or regions may choose to add it to this curriculum. The instructor is required to provide each student with supplementary documentation indicating the additional steps necessary for compliance.



Figure 2:59

## Head Lashing (Figures 2:60 to 2:63)

- Any of the head lashings learned in LARR are acceptable.

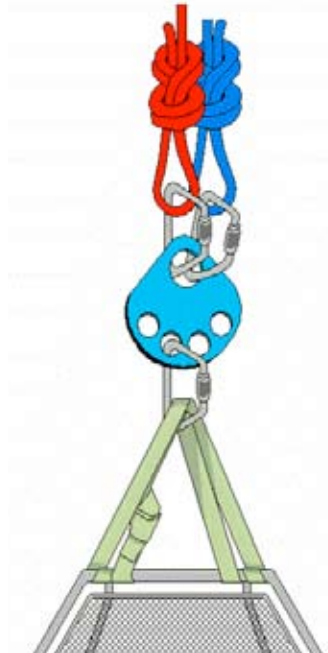


Figure 2:60 5-foot Webbing



Figure 2:61 8-foot Lifeline

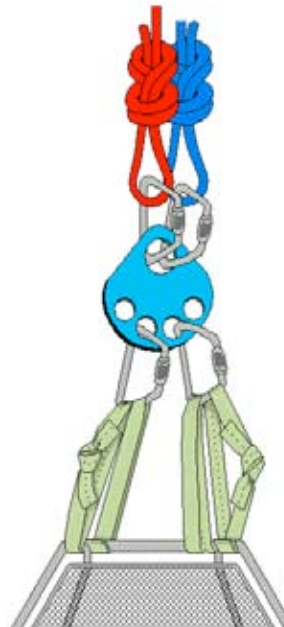


Figure 2:62 Prerig

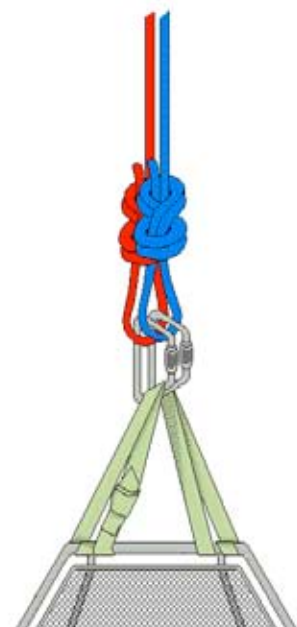


Figure 2:63 Without an anchor plate

### Advantages of Each

- Figure 2:60 Compact and simple to tie, prerig, and attach
- Figure 2:61 Strong and abrasion resistant
- Figure 2:62 Webbing backed up and separate
- Figure 2:63 Less equipment required

### Disadvantages of Each

- Least strength
- May be bulky to tie and attach to
- Most complicated to construct
- Difficult to modify configuration

## Head Lashing with the Main and Belay/Safety Lines

1. Form a Figure Eight with 3' to 4' of tail at the end of the main line.
2. Wrap the tail around the main frame at the head of the rescue litter. Begin outside one of the skids and end outside the opposite skid.
3. Tie a Figure Eight Follow Through with the remaining tail.
4. Repeat steps for belay/safety line.



Figure 2:65



Figure 2:64

## Rescue Litter Attachments to a Rope Rescue System—Horizontal

Litters are attached to the ends of the main line and the belay/safety line with a litter prerig. This prerig supports the litter at four points and provides adjustability to the litter's attitude and tilt. The litter can be adjusted head up, which is preferred by conscious victims, head dependent for victims in shock, or laterally for victims who are vomiting.

Some agencies require an additional connection from the victim to the main, belay/safety, or both lines as a backup. Although this is not required for completion of this course, some agencies/regions may choose to add it to this curriculum. The instructor is required to provide each student with supplementary documentation indicating the additional steps necessary for compliance.

Prerig prusiks may be slid up to make it easier to move the litter in/out of short openings.

If desired, the anchor plate may be omitted to reduce the litter's profile.

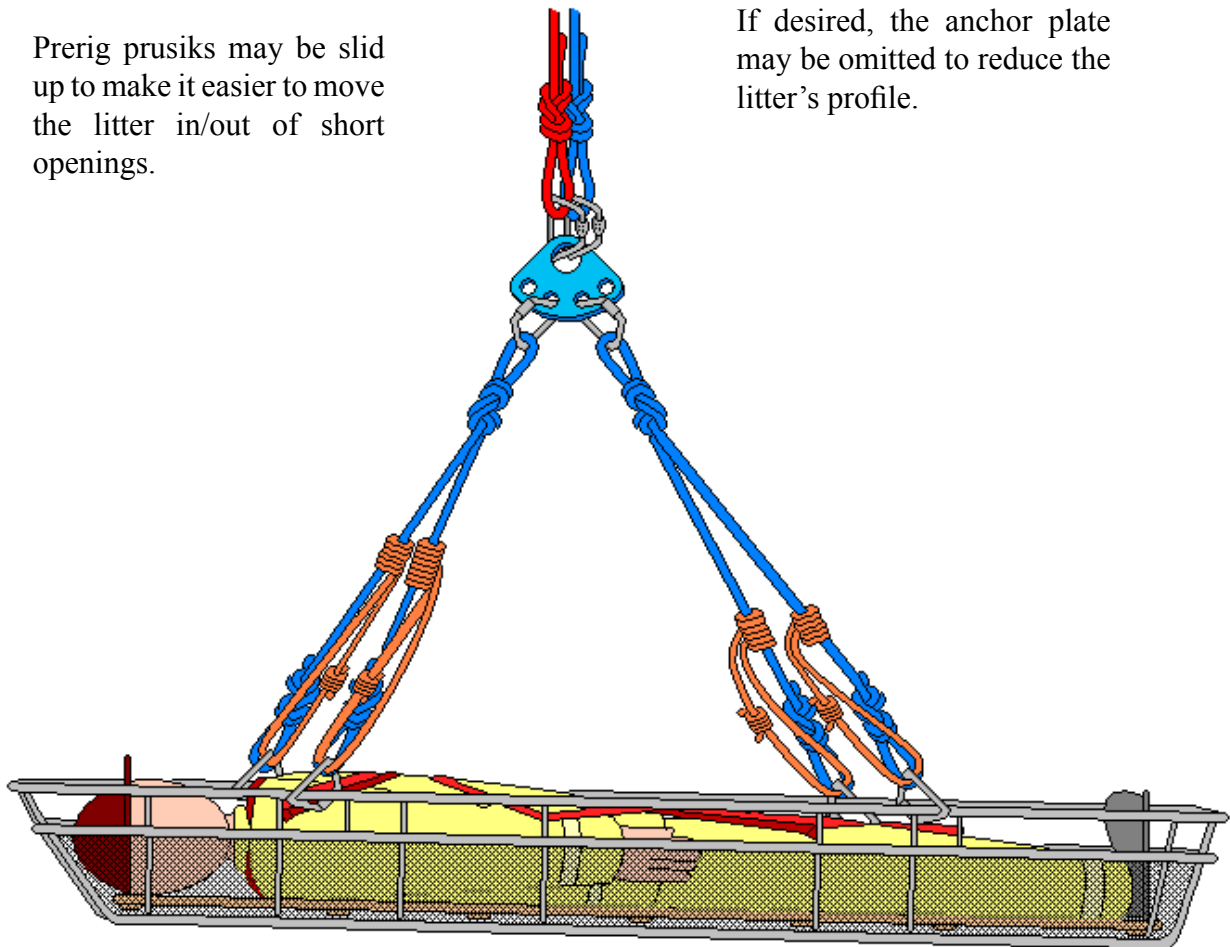


Figure 2:66

## Rescue Litter Tending

In certain situations, it may be necessary to tend the litter during a nonambulatory victim rescue where the vertical surface is uneven or has ledges that would cause the litter to become hung up. These obstructions are most easily dealt with by the use of taglines tended from the ground. The objective is to pull the litter away from the obstruction via the tagline when the litter approaches it and then release it when clear. Taglines and ground tenders are also useful in landing the litter away from the base of a structure when a rubble pile exists or when assisting rescuers retrieve a litter through a narrow opening in the wall by rotating one end away from the opening. This is often referred to as “flagging” the litter and is most easily accomplished with the use of two taglines, one at each end.



Figure 2:67



Figure 2:68

The method depicted above is the preferred method because it allows the ground tender to rotate (flag) the litter. This method can be configured with two taglines or one tagline with each end tied to opposite ends of the litter.

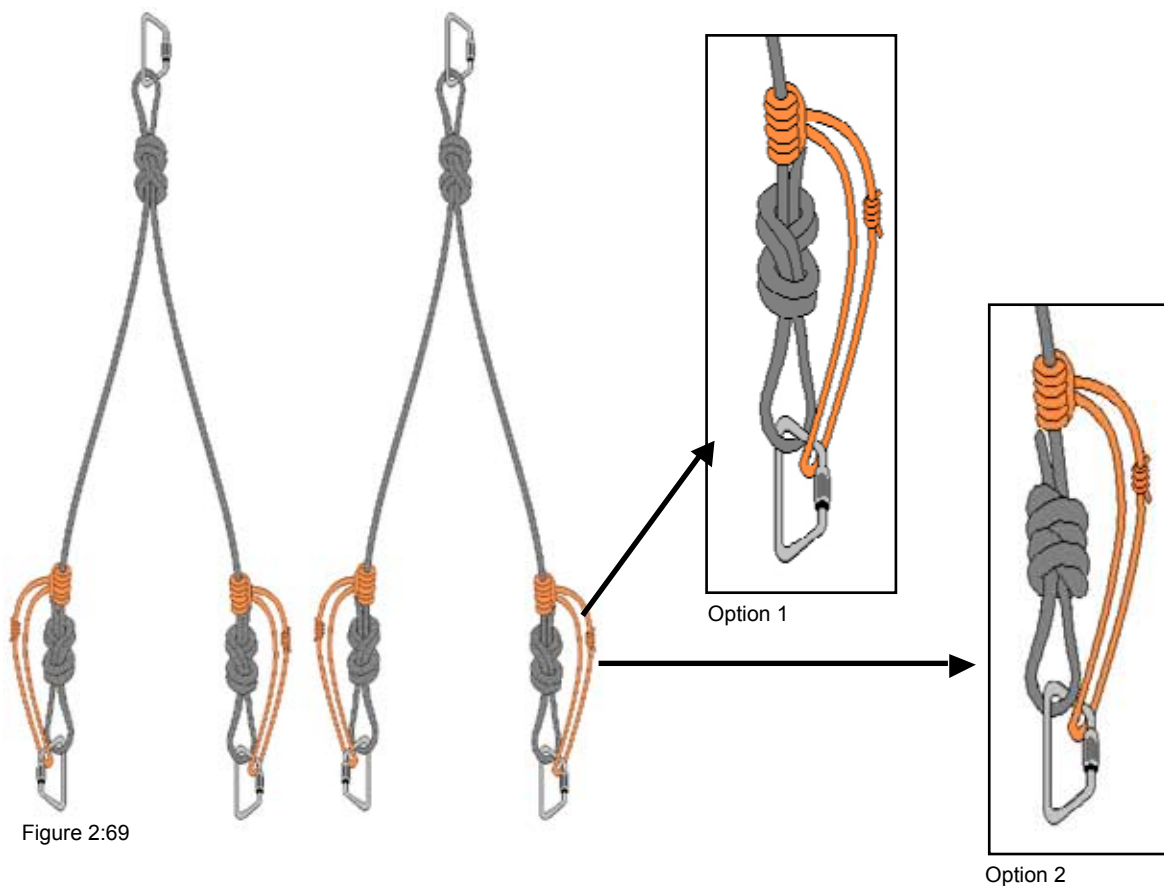
On the left is the single tagline method, which is less desirable due to reduced mobility but may be the only option if limited to a single rope that is too short to reach the ground with both ends tied to the litter.

## Litter Prerig

A prerig is an adjustable pretied combination of lifeline, prusiks, and carabiners. It is used to connect the rescue lines to the litter. The adjustability of the prerig allows it to be used in low-angle, high-angle, or high-line operations. A prerig consists of two bridles as shown in Figure 2:69.

### Bridle Construction

1. Tie a Figure Eight on a Bight or a Double Overhand on a Bight in the middle of a 16-foot section of lifeline and attach a NFPA General Use carabiner to this knot.
2. Tie a Figure Eight on a Bight into each end of the 16-foot section of lifeline and attach NFPA General Use carabiner to each knot.
3. Attach a three-wrap prusik to each leg of the prerig and clip the prusik loop into the carabiner at the end of each leg.







# RESCUE SYSTEMS 1

## Basic Rescue Skills



### Topic 2-4: Rescuer and Ambulatory Victim Packaging

## **Fall Restraint**

Personnel exposed to a potentially hazardous fall should be protected with a fall restraint system. A fall restraint system is assembled to prevent the rescuer from falling off an edge. The purpose of a fall restraint system is to prevent injury by limiting the distance a person can travel, while still allowing the necessary degree of movement to perform the assignment. The fall restraint system consists of an anchor, approved harness, lifeline, and related hardware and software adjusted to prevent an employee from falling.

## **Standard**

The standard that governs fall protection is in Title 8 of the California Code of Regulations, §1670. This standard specifically defines industry standards for the construction industry. These standards may not be applicable to fire and rescue emergency operations, but definitely are during training.

## **Always Consider the Following**

When should a fall restraint system be attached to a rescuer working on or near an edge in a rescue operation?

- Is there a real potential for a rescuer to fall? An example would be a rescuer assigned to manage rope protection that is positioned within a body length of the edge of a steep or slippery roof.
- Will fall restraint lines create more hazard potential than protection potential for the rescuer?
- Is the Safety Officer and/or an appointed lookout not available to provide visual supervision to keep rescuers from moving in and out of fall-risk areas.

Provide continuous evaluation of the scene as operations progress.

## **Components of a Fall Restraint System**

- An adequate anchor that is able to support a single-person load and in line with the working area and the rescuer to be restrained
- An appropriate length of lifeline attached to the anchor and rescuer
  - No more line than required to reach the edge
  - With a means of adjusting the length at one or both ends of the line
    - Having adjustment capability at both ends of the system allows large adjustments to be made at the anchor end and fine adjustments to be made at the rescuer's end.
    - This allows fine-tuning of the line length by the rescuer while limiting the potential for extra rope to gather near the rescuer's feet, creating a tripping hazard.

## How to Construct a Fall Restraint System

1. Identify the anchor point to be used.
2. Tie a Figure Eight on a Bight on one end of the lifeline and toss it from a safe distance to the edge.
3. Extend the line to the anchor.
4. Attach the line to the anchor using either of the following methods.

### *Using a Clove Hitch*

This method reduces the equipment needed to a cylindrical object and a lifeline.

1. Form a Clove Hitch around the cylindrical object.
2. Pay out 3' of slack from behind the knot.
3. Form a Figure Eight Follow Through around the object.
4. The Clove Hitch can be used for adjustment.
5. The Figure Eight follow through is a backup to the Clove Hitch.

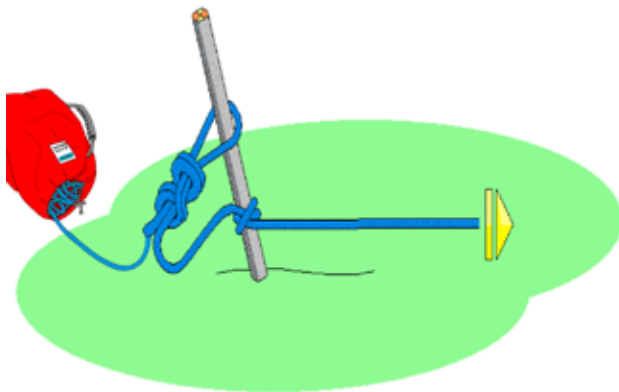


Figure 2:70 Using a picket

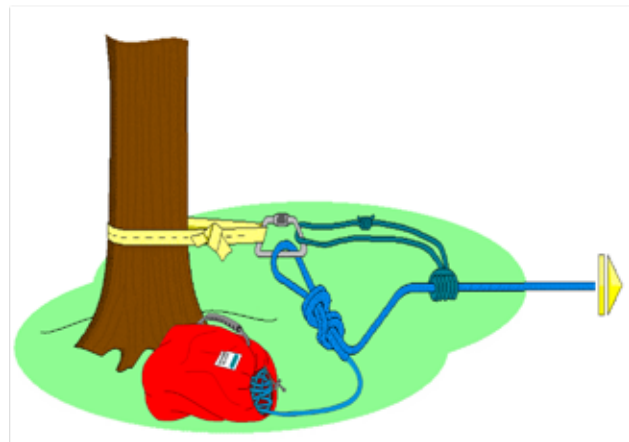


Figure 2:71 Other than a picket

### *Using an Anchor Other than a Cylindrical Object*

This method can also be used with a cylindrical anchor.

1. Attach a sling and carabiner to the selected anchor.
2. Form a three-wrap prusik on the line and attach it to the carabiner on the anchor sling.
3. Pay out 3' of slack from behind the prusik and tie a Figure Eight on a Bight.
4. Attach the Figure Eight on a Bight to the carabiner on the anchor sling.
5. The prusik can be used for adjustment.

## How to Construct a Fall Restraint System – Rescuer Connections

1. Retrieve the end of the rope with the Figure Eight on a Bight from the edge.
2. Attach the end of the line to the rescuer using either of the following methods.
3. These systems are not intended to arrest a fall, they are to eliminate the fall by limiting the rescuer's travel.

### *Direct, Nonadjustable Attachment*

This method uses the least amount of equipment to connect and results in less slack line to maintain, reducing tripping hazards.

1. Attach the Figure Eight on a Bight knot in the end of the fall restraint line to the rescuer's harness with a carabiner. Attachment can be made to either the front or rear D-ring attachment on the harness.

### *Adjustable Attachment*

1. Place a three-wrap prusik just behind the Figure Eight on a Bight in the end of the fall restraint line.
2. Attach a carabiner to both the Figure Eight on a Bight and the prusik.
3. Connect the carabiner to the front D-ring on the rescuer's harness.
4. The prusik allows the rescuer to make his or her own adjustments as needed.

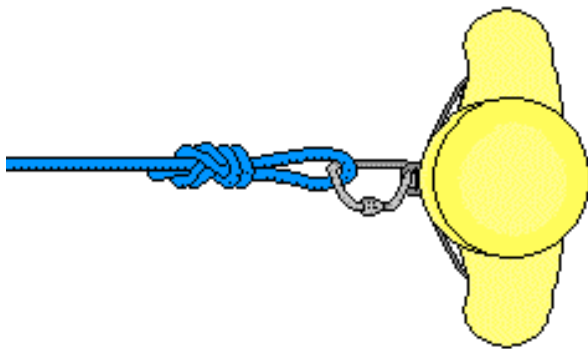


Figure 2:72 Direct, Nonadjustable Attachment

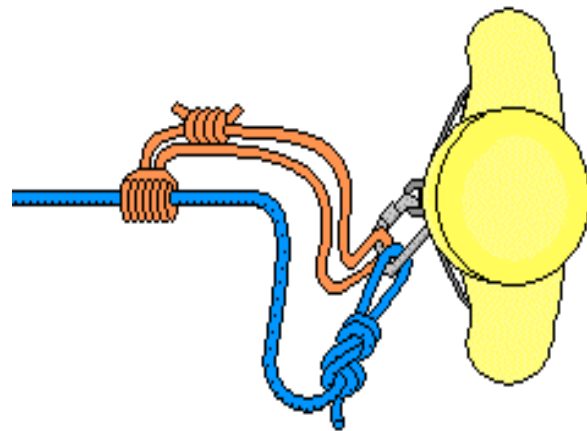


Figure 2:73 Adjustable Attachment



# RESCUE SYSTEMS 1

## Basic Rescue Skills

### Topic 2-5: Belay/Safety Line Systems



## Topic 2-5: Belay/Safety Line Systems

**Scope:** This chapter serves as a review of Belay/Safety Lines learned in the prerequisite Low Angle Rope Rescue Operational (LARRO) course and will introduce and provide instruction on additional knowledge and skills that may be required for Rescue Systems 1 skills.

**Terminal Learning Objective (TLO) identified in LARR:** At the end of this chapter, the student will be aware of the importance of using a backup line to catch the load in the event of a failure of the main line.

**Enabling Learning Objectives (ELO) identified in LARR:**

1. Define key points regarding the operation of a belay/safety line system.
2. Demonstrate belay/safety line configurations.
3. Demonstrate lowering operations—basic configuration.
4. Demonstrate retrieval operations—basic configuration.
5. Describe system variations.

The Low Angle Rope Rescue Operational (LARRO) course provided detailed information to the student related to belay/safety lines. The student will be asked to demonstrate these learned skills.

In all emergency operations, the words “Safety First” need to be more than a catchy phrase. Rope rescue operations are no exception to this rule. An important part of ensuring safety is the use of a backup line to catch the load in the event of a failure of the main line.

Many teams refer to this backup line as the “belay line.” This is a mountaineering term meaning “to hold fast or provide security.”

Other teams refer to this line as the “safety line.” With this orientation, the term “Safety First” can provide a verbal reference to the backup line and reinforce the concept of staffing, checking, and attaching the belay/safety line first in all operations.

This manual will use both terms with the understanding that local agencies will use one or the other as their reference. With that being said, the belay/safety line systems and operations that are presented here *must be followed without exception.*

### Key Points Regarding the Operation of Belay/Safety Line Systems

- The entire operation is only as safe as the belay/safety line system, its anchor, and its operator.
- Personnel staffing the belay/safety line must have sound operational skills. These skills are perishable and their maintenance requires regular hands-on practice under the supervision of a qualified person.
- Communication is essential during the operation of these systems.** The “edge” position is a critical link in the safe operation of the belay/safety line system. The edge person will communicate to the belay/safety line tender the amount of line and speed needed to accommodate the rescuer’s needs. On occasion, the rescuer may need to move rapidly over an area.

- The Safety Officer or Rescue Group Supervisor may fill the role of “edge” as dictated by staffing and operational needs.
- Rope rescue operations are a go only when the “edge” position is filled.

## Belay/Safety Line Configurations

### Basic Configuration

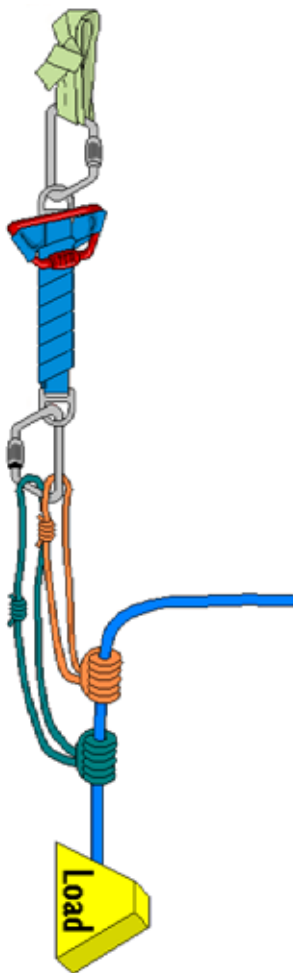


Figure 2:74

The basic belay/safety line configuration does not use the prusik minding pulley. This configuration does not provide for rapid retrieval of an unloaded line; however, it will allow the tender better “feel” of systems operation.

This configuration allows the belayer to feed or pull the line 90° from the direction of travel. This is the best method to minimize the potential of the tandem prusiks not arresting a fall when let go.

It also minimizes the potential of prusiks to grab or jam and reduces the potential for damage to system components (line and prusiks) caused by the heat of friction. The potential for system problems associated with the use of the prusik minding pulley in the systems is eliminated.

## Prusik Minding Pulley Configuration

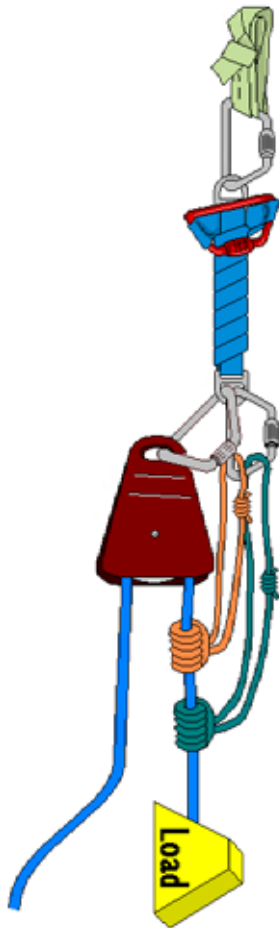


Figure 2:75

The prusik minding pulley (PMP) allows the belayer to retrieve the belay/safety line with hand-over-hand motion. This provides a quick method of retrieving a line that has been disconnected from the load.

This configuration can also be used while retrieving a belay/safety line during raising operations. **CAUTION:** Belaying through the pulley may render the prusiks ineffective. The operator must ensure that the proper amount of tension is maintained in the prusik hitches around the belay/safety line. Excessive grip of the prusik to the line will cause the tandem prusiks to jam or be damaged due to the heat of friction.

Extreme caution must be used if using this system to protect the load during lowering operations. The weight of the additional hardware can cause the tandem prusiks to grab unexpectedly. The system may be placed flat on the ground to prevent this.

**Prusik hitches that are too loose or improperly tended in this configuration will not arrest a fall.**

## Lowering Operations – Basic Configuration

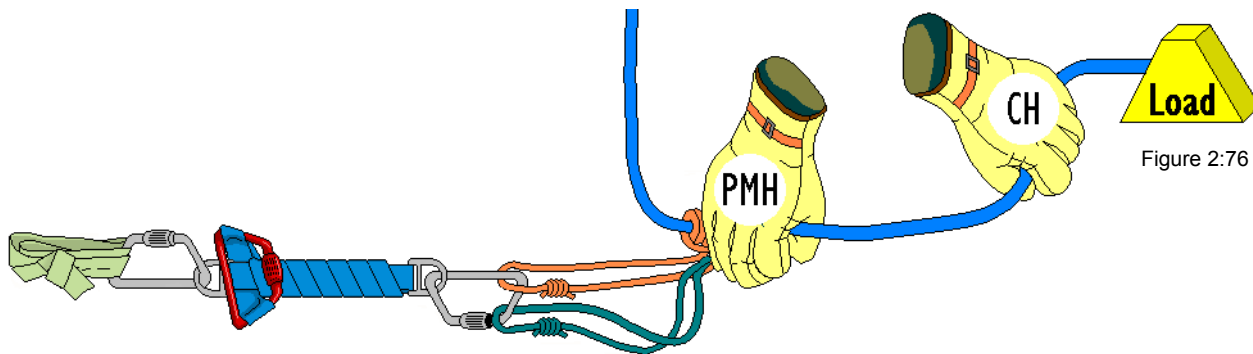


Figure 2:76

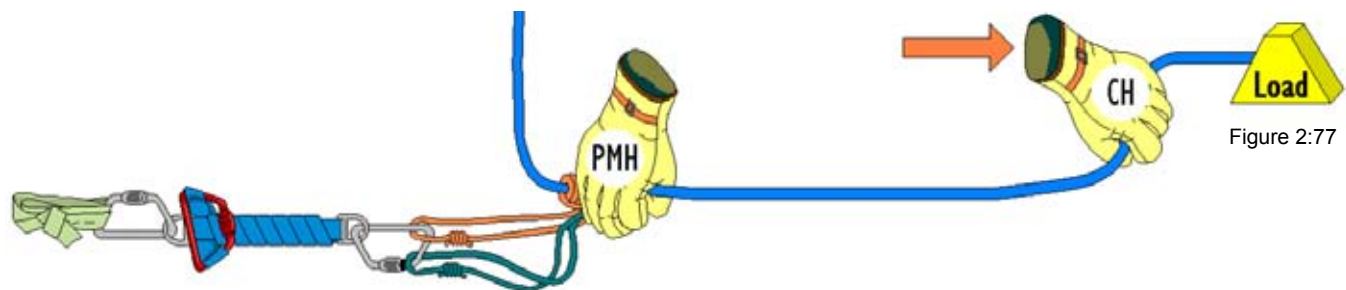
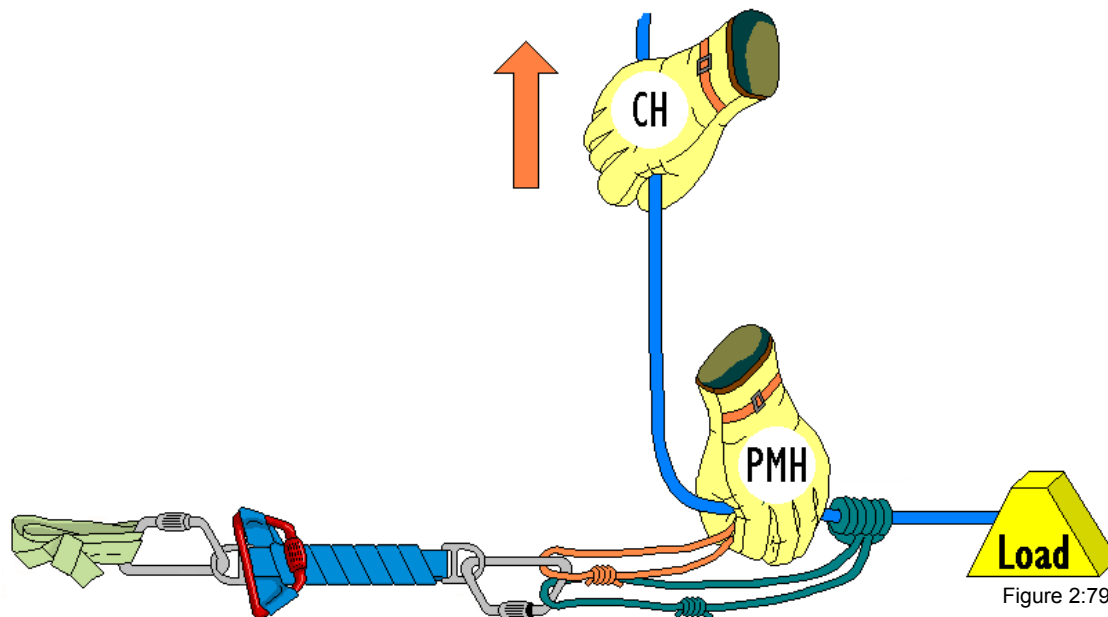
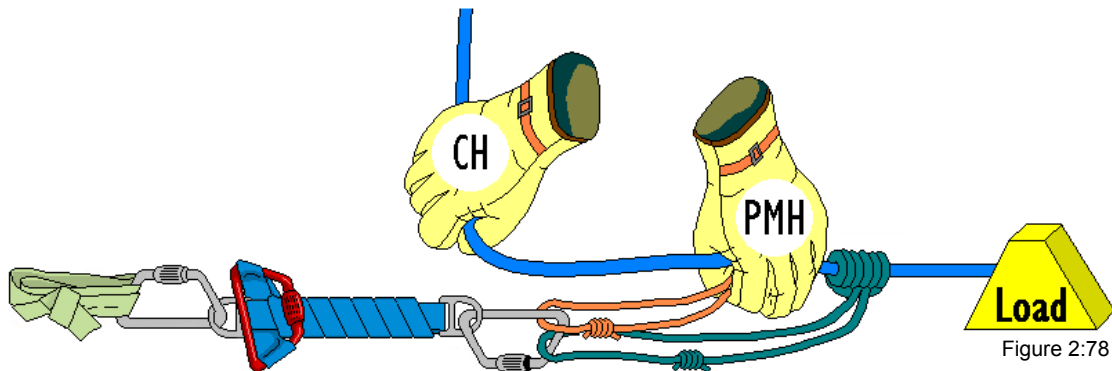


Figure 2:77

1. Place rope bag away from the direction of travel so the line feeds into the tandem prusiks at 90°.
2. **Prusik Minding Hand (PMH)** – Form a circle with the index finger and thumb around the line and against the load side of the long prusik.
3. **Control Hand (CH)** – Grasp the line on the load side of the tandem prusiks.
4. **Control Hand** – Angle the line with the hand as shown.
5. **Prusik Minding Hand** – Slide the long prusik toward the anchor until it contacts the short prusik and rest the remaining fingers of the **prusik minding hand** on the short prusik.
6. **Prusik Minding Hand** – Slide the tandem prusiks toward the anchor to develop 2" to 3" of slack.
7. **Control Hand** – As the load moves away from the anchor, pull the line through the tandem prusiks to maintain less than 2' of slack in the line.
8. **Control Hand** – When arm's length is reached, repeat Step 6.

When pull straightens the angle at the control hand, set the prusiks unless otherwise directed.

## Retrieval Operations – Basic Configuration



1. **Prusik Minding Hand** – Form a circle with the index finger and thumb around the line and against the anchor side of the short prusik.
2. **Prusik Minding Hand** – Short prusik remains taut throughout the operation.
3. **Control Hand** – Grasp the line on the anchor side of the tandem prusiks.
4. **Control Hand** – Angle the line with the hand as shown.
5. **Control Hand** – As slack develops during retrieval, pull the line through the tandem prusiks to maintain a taut line.
6. **Prusik Minding Hand** – As the line is retrieved by the control hand, the long prusik will move to contact the short prusik. Rest the remaining fingers of the **prusik minding hand** on the long prusik.
7. **Control Hand** – When arm’s length is reached, repeat Steps 3, 4, and 5.

When direction of travel reverses, properly tended prusiks will set.

Tandem prusiks are commonly set by “throwing” them toward the load with the prusik minding hand.



## Lowering Operations – PMP Configuration (Optional)

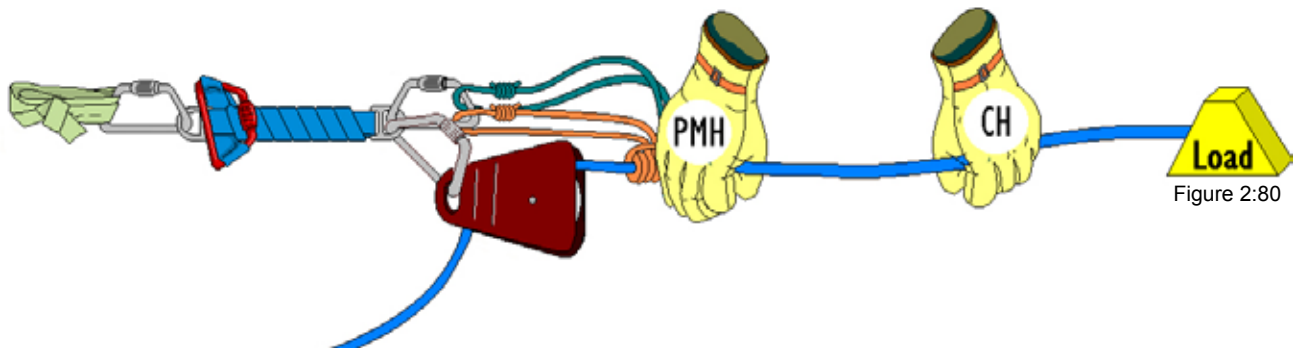


Figure 2:80

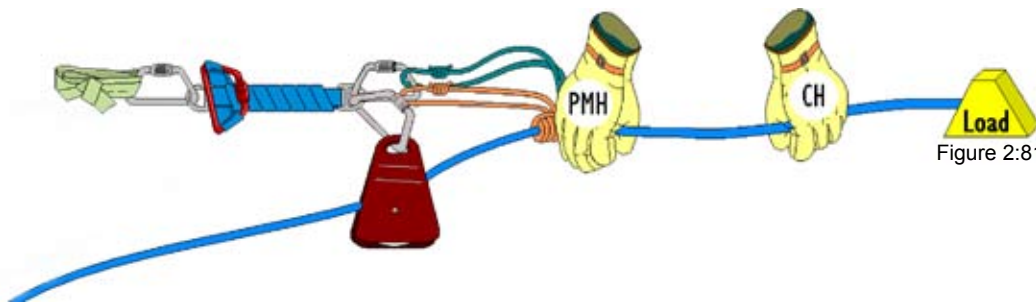


Figure 2:81

If possible, open the angle of the line in the pulley as shown. This will allow the line to feed through the system more easily, but this will potentially keep the system from arresting a fall by having the line feed straight through the tandem prusiks.

1. **Prusik Minding Hand** – Form a circle with the index finger and thumb around the line and against the load side of the long prusik.
2. **Control Hand** – Grasp the line on the load side of the tandem prusiks.
3. **Control Hand** – Angle the line with the hand as shown.
4. **Prusik Minding Hand** – Slide the long prusik toward the anchor until it contacts the short prusik and rest the remaining fingers of the **prusik minding hand** on the short prusik.
5. **Prusik Minding Hand** – Slide the tandem prusiks toward the anchor to develop 2" to 3" of slack.
6. **Control Hand** – As the load moves away from the anchor, pull the line through the tandem prusiks to maintain less than 2' of slack in the line.
7. **Control Hand** – When arm's length is reached, repeat Step 6.

When pull straightens the angle at the control hand, set the prusiks unless otherwise directed.

Tandem prusiks are commonly set by "throwing" them toward the load with the prusik minding hand.

## Retrieval Operations – PMP Configuration (Optional)

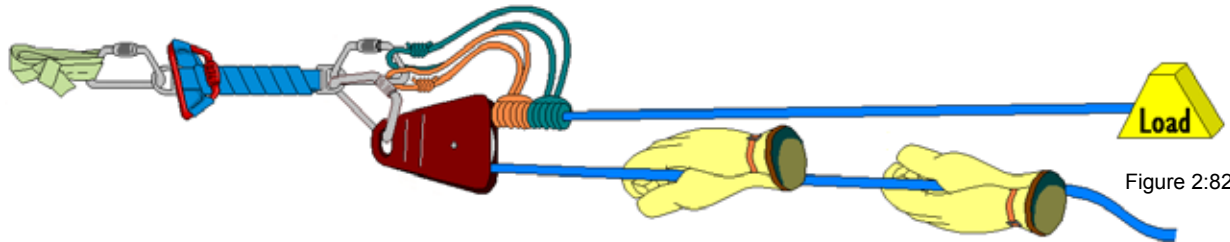


Figure 2:82

1. With one hand, grasp the line on the side opposite the tandem prusiks 2' below the pulley.
2. With the other hand, grasp the line on the same side of the pulley a comfortable distance away from the first hand.
3. Pull the line hand-over-hand, away from the anchor.

### **Key Points**

- Maintain a 2-foot spacing between hands and pulley to avoid possible entanglement in pulley.
- The line must be maintained at 180° in and out of the prusik minding pulley.
- Prusiks must ride squarely on the bottom edge of the pulley.
- Prusiks allowed to ride up the side of the pulley may jam or be damaged by the heat of friction.
- When direction of travel reverses, the prusiks will set.

### **System Variations**

It is common to see the basic belay/safety system configuration used during lowering operations and the belay/safety line system with the prusik minding pulley used during retrieval operations.

### **Dual RPMs Configuration**

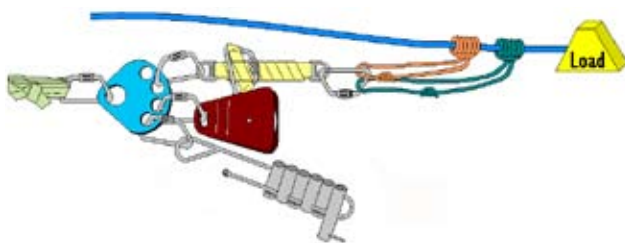


Figure 2:83 Basic Configuration – Lower

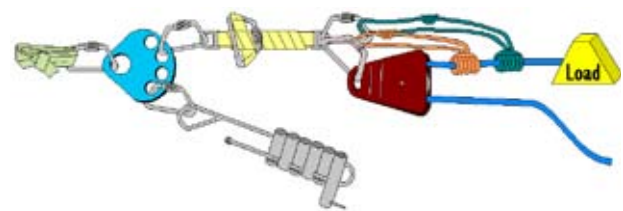


Figure 2:84 PMP Configuration – Retrieve

### **Key Points**

- A belay/safety line system shall be used any time a main line is used (two-line systems).
- The belay/safety line system is the most critical part of any rope system as it provides for fall arrest in the event of main line system failure.
- The operation of this system is a critical skill requiring a high degree of knowledge and proficiency.
- Whenever possible keep the line from traveling in line with the tandem prusiks and the load.



---

# RESCUE SYSTEMS 1

## Basic Rescue Skills

---

### Topic 2-5: Belay/Safety Line Systems

---



## Topic 2-6: Rappelling / Descending

### TERMINAL OBJECTIVE:

The student will be able construct and operate rope rescue descending systems.

### ENABLING OBJECTIVES:

1. Describe descending techniques.
2. Demonstrate how to construct a fixed line for a rappel.3
3. Demonstrate how to reeve a Figure Eight descender and brake bar rack.
4. Demonstrate a rappel and lock-off using a Figure Eight descender and brake bar rack.
5. Demonstrate a rappel using a Figure Eight descender and brake bar rack with a high and low anchor point.

## Descending

Descending, or what is more commonly referred to as rappelling, is a seldom-used element of team-based high-angle rope rescue. In most situations, it is better to lower rescuers to an incident; however, on occasion, a rescuer needs to rappel to access the site. For instance, a fixed (rappel) line may be necessary when multiple rescuers are needed quickly at the bottom. Rappelling is a valuable skill that teaches the use of different rescue equipment and builds confidence in the rescuer's ability, equipment, and team capability.

Rappelling is a dangerous activity, however, and must be completed under controlled conditions. A proper rappel is a slow, controlled walk down the vertical surface. A slow, steady descent is much easier on ropes and anchors and prevents serious heat buildup from friction that can damage nylon ropes. A fast, bounding rappel has no place in the rescue service and only serves to overheat the descent control device (DCD) and shock-load the anchors and their components.

## Types of Descent Control Devices (DCD)

### *Figure Eight Descender (Eight Plate) Brake Bar Rack*



Figure 2:85 With Long Ears



Figure 2:86 With Short Ears

Count the Bars in This Order  
6 5 4 3 2 1

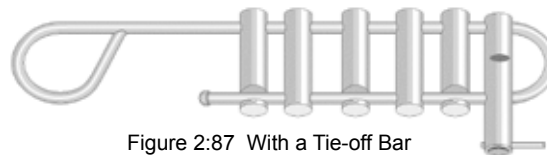


Figure 2:87 With a Tie-off Bar

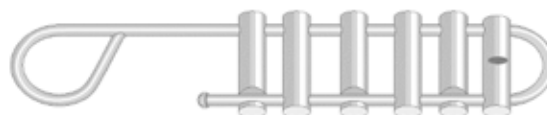


Figure 2:88 Without a Tie-off Bar  
(Non NFPA Compliant)

## **Rigging a Fixed Line**

- Attach a Resistance Pulley/Mariners Hitch (RPM) to a suitable anchor.
- Always tie a Figure Eight stopper knot in the end of any rappel line. This reduces the potential for rappelling off the end of the line.
- Pay out enough line to reach the desired location.
- Reeve line through the DCD on the RPM.
  - Maintain a minimum 20-foot tail in the fixed line.
  - Lock-off the DCD (illustrated later in this chapter).

## **Belay/Safety Line**

- The anchor must be located in line with the main line. This prevents a pendulum action if the main line fails.
- Construct a belay/safety line system.

## **Line Attachments**

The rescuer dons a NFPA Class III harness, positions a safe distance from the edge, and faces the anchor with the fixed/rappel line on the right side. The belay/safety line and DCD should attach to separate carabiners at the rescuer's harness.

- Belay/safety line
  1. Tie a Figure Eight on a Bight in the end of the belay/safety line.
  2. Attach the Figure Eight on a Bight to the dorsal ring on the rescuer's harness (see optional belay/safety attachment).
- Fixed/rappel line
  1. Reeve DCD.
  2. Ensure DCD is secured to the rescuer's harness.



Figure 2:89 Line Attachments



Figure 2:90 Optional Belay/Safety Attachment

Figure 2:90 depicts the rescuer with optional belay/safety line attachment. In some cases it may be necessary to attach the belay/safety to the chest D-ring.

## Rappel Position

The rescuer's lower body should always be perpendicular to the vertical surface, with both feet flat on the surface, shoulder width apart, with knees slightly bent in order to maintain footing. This perpendicular position needs to be maintained if there is any change in the angle during the descent. The upper body should be upright so the rescuer appears to be in a seated position.

## Hand Position

The hand position changes depending on the DCD.

### *Figure Eight Descender*

- Brake hand
  - Grasps the rope.
  - Pulls it tight around the hip.
  - Holds it tight with the fist positioned at the buttocks.
- Control hand
  - Is positioned either in front of the descender or just below it to help control the body posture. This is considered to be the full brake position.
  - The friction can be decreased by moving the braking hand away from the buttocks and hip while stepping backward until the desired speed is achieved.

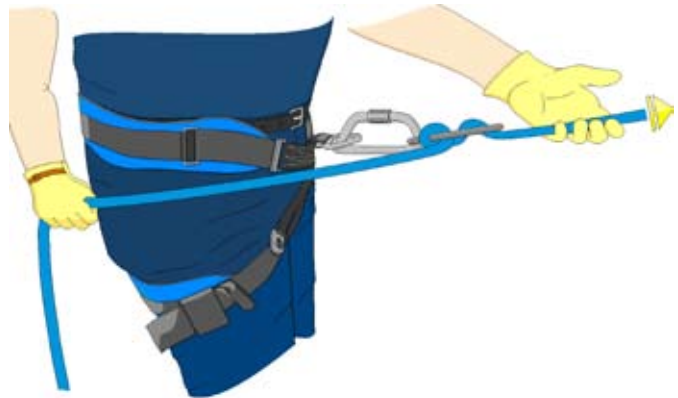


Figure 2:91 Hand Placement for a Figure Eight Descender

## Brake Bar Rack

### ☐ Brake hand

- Grasps the rope where it comes out of the bottom of the rack.
- Wraps it around either the 4<sup>th</sup> or 5<sup>th</sup> bar.
  - This depends on the weight of the rescuer.
  - It is always better to begin a rappel with more bars and remove them if necessary rather than not have enough bars.
- Is kept in the twelve o'clock position above the rack.

### ☐ Control hand

- Is positioned underneath the rack cradling the bars. This is considered to be the full brake position.
- Varies friction by spreading out the bars on the rack while stepping backward and moving the braking hand from the twelve o'clock to the five o'clock position. The friction can be varied by adding or removing bars until the desired speed is achieved.
- May be positioned either in front of the descender or just below it to help control the body's posture once the desired speed has been achieved.

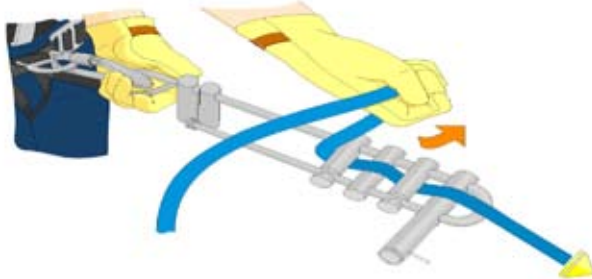


Figure 2:92 More Friction

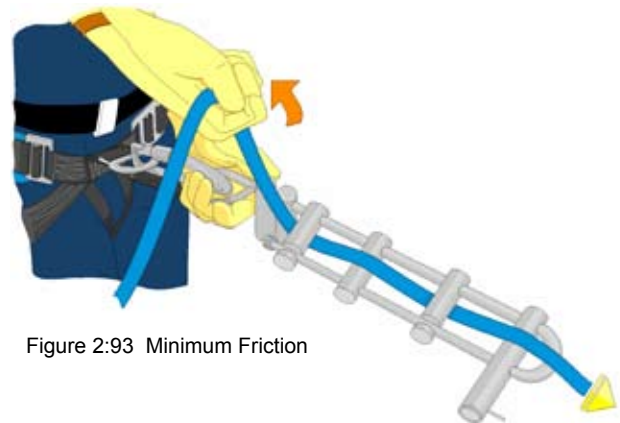


Figure 2:93 Minimum Friction

## Departure

Departing the edge during a rappel can be a dangerous and complex procedure. Prior to beginning this procedure the rescuer needs to communicate with the belay/safety line tender to ensure that the safety line is ready. A high anchor point is desired for edge departures. When rescuers are unable to anchor the rope above the departure point, a low anchor point departure is necessary.

## High Anchor Point Departure

Once on belay, the rescuer begins walking backward to the edge. The rescuer maintains the rappel or full brake position with his or her hands. The rescuer also maintains tension on the fixed/rappel line when walking backward. Once at the edge, the rescuer maintains foot position on the edge while lowering body into rappel position with legs perpendicular to vertical surface. Once in position, the rescuer can begin the rappel.

- Advantages
  - Is safest edge transition
  - Maintains tension on main line
  - Limits shock load potential
  - Prevents side-loaded carabiners
- Disadvantages
  - Is not always available
  - Can take excessive gear or time to set up

## Low Anchor Departure Point

Once on belay, the rescuer approaches the edge and removes slack in line between the anchor and the edge. The rescuer then grabs the rappel line 1" beyond the edge, then reeves the DCD so this point is at the top of the DCD. This will ensure that the DCD does not become damaged on the edge once the rescuer transitions off the edge. The rescuer sits down at edge with legs hanging down along vertical surface. The rescuer is seated so the main line from anchor runs along control hand side of body. The control hand is placed on the edge between the buttocks and the mainline. Maintaining control on brake hand and tension in main line, the rescuer rolls body toward control hand and eases down onto vertical surface by supporting body weight with control hand until suspended by the mainline. The rescuer then assumes the rappel position with legs perpendicular to surface and begins rappel.

- Advantage: Uses simple and expedient setup of anchor
- Disadvantages
  - Does not maintain tension on main line
  - Allows possible side-loading of carabiners
  - Potentially shock-loads system

## Lock-off

During a rappel, it may be necessary for the rescuer to stop the descent to perform work, package a victim, or rest. It is necessary to lock-off the descender, whether it is a Figure Eight descender or a brake bar rack, until the rescuer is ready to continue the descent. Locking-off enables the rescuer to hang suspended on the main line and have the hands free to perform a function with a degree of safety. When the rescuer is ready to descend, he or she simply reverses the lock-off procedure and continues the descent.



## Figure Eight Descender

1. Allow the brake hand to move from the back of the hip to the front and hold tight when the desired lock-off point has been reached.



Figure 2:94 Grasp the Connection Point



Figure 2:95 Pull the Running End of the Rope

2. Grasp the connection point where the descender meets the carabiner with the control hand and rotate the descender toward the brake hand.
3. Pull the running end of the rope up and across the back of the descender between the standing part of the rope and the descender with the brake hand until it pops between the large hole in the descender and the main line.

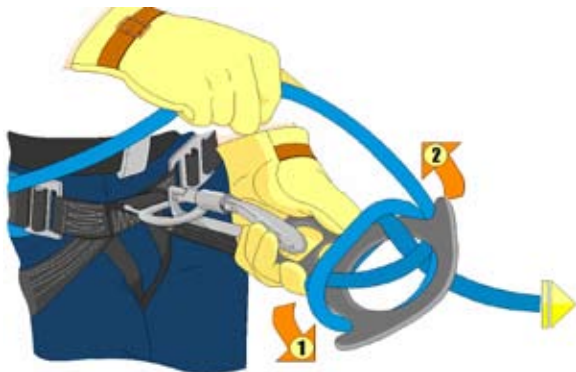


Figure 2:96 Wrap the Running End



Figure 2:97 Pull the Line to the Right

4. Create a second wrap around the descender by repeating Step 3. Pull the line firmly to set both wraps.
5. Pull the line to the right, across the neck of the DCD, and through the carabiner from right to left to form an 8" to 10" bight.



Figure 2:98 Twist the Bight Clockwise



Figure 2:100 Pass the Loop over the Top

6. Twist the bight as shown to form a loop.

7. Pass the loop over the top of the descender.



Figure 2:99 Pull the Running End to Tighten

8. Pull the running end to tighten the loop.

**Heavier rescuers may choose to substitute steps 3 and 4 with the following reverse wraps that create more friction during the initiation and the removal of the lock-off.**



Figure 2:101



Figure 2:102

**Refer back to step 5 and continue.**

## *Brake Bar Rack with a Tie-off Bar*

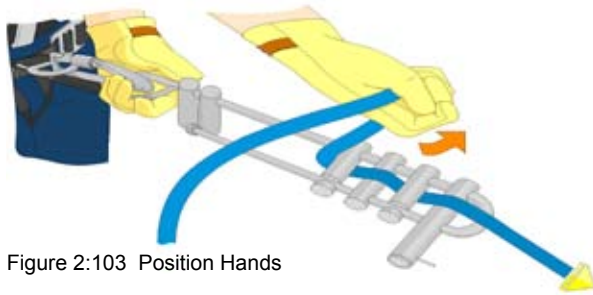


Figure 2:103 Position Hands

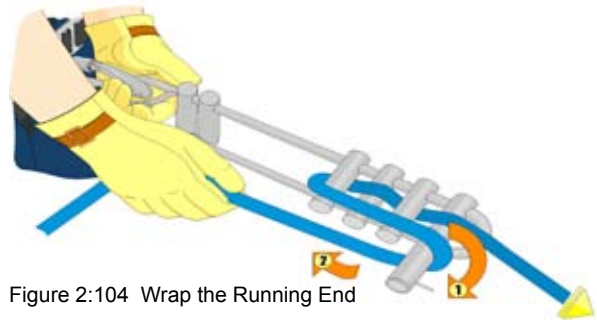


Figure 2:104 Wrap the Running End

1. Position hands in the full brake position.

2. Wrap the running end around the tie-off bar with the brake hand.

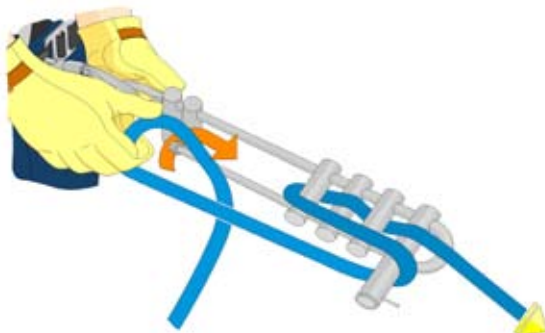


Figure 2:105 Form a Half Hitch

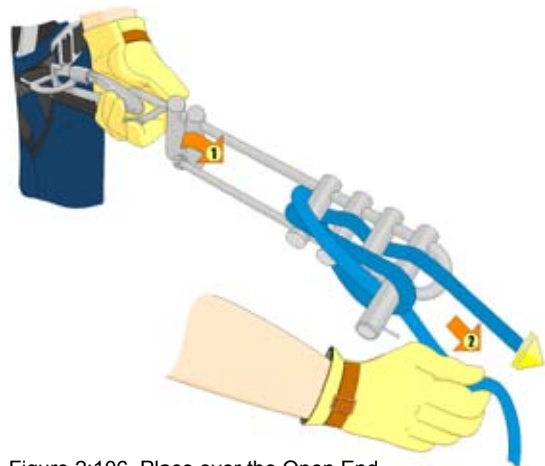


Figure 2:106 Place over the Open End

3. Form a Half Hitch in the running end near the opening of the rack.

4. Place the Half Hitch over the open end of the brake bar rack and pull on the running end to tighten the Half Hitch.

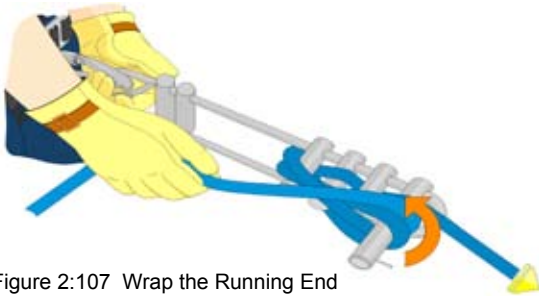


Figure 2:107 Wrap the Running End

5. Wrap the running end around the tie-off bar a second time, but in the opposite direction.

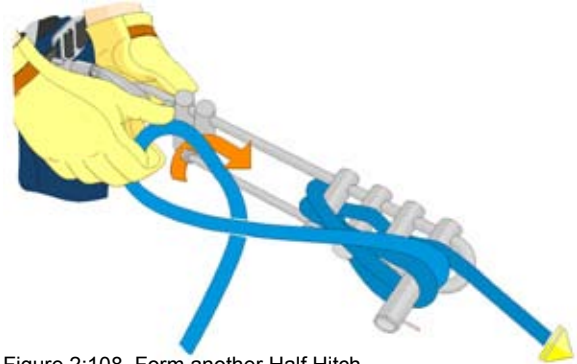


Figure 2:108 Form another Half Hitch

6. Form another Half Hitch in the running end and place it over the open end of the rack.

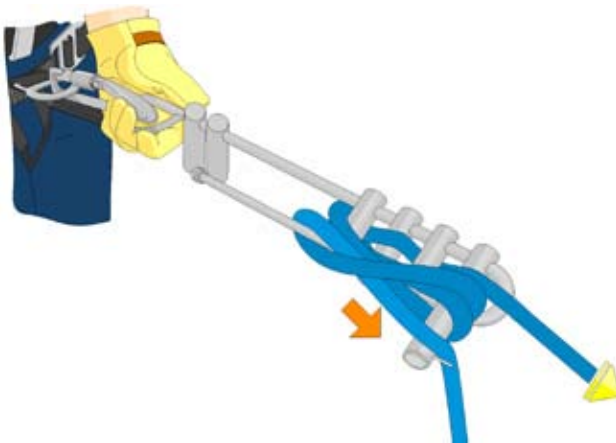


Figure 2:109 Pull the Running End to Tighten

7. Pull the running end to tighten second Half Hitch and place over the tie-off bar.



# RESCUE SYSTEMS 1

## Basic Rescue Skills

### Topic 2-6: Rappelling / Descending



## **How to Escape from a Jammed DCD**

### ***Topside (Team-Based) Recovery Option***

- Rescuer
  - Attaches a long prusik loop to the line in front of the DCD and connects it to an extra carabiner on the harness
  - Slides prusik forward and leans back in order to tension/load the prusik
- Topside Crew
  - Changes the fixed line over to a raising system and raises the rescuer to the top or a safe location to unjam the DCD
  - Or
  - Unlocks DCD at RPM and lowers rescuer to bottom or safe location to unjam DCD



# RESCUE SYSTEMS 1

## Basic Rescue Skills



### Topic 2-7: Lower and Raise Main Line Systems

## Topic 2-7: Lower and Raise Main Line Systems

**Terminal Objective (TLO):** At the end of this chapter, the student will be able to

**Enabling Objectives (ELO):**

1. Describe rope rescue lowering and raising systems.
2. Demonstrate how to operate a lowering system.
3. Demonstrate how to convert a lowering system to a raising system with a 3:1 and a 5:1 in-line—RPM.
4. Demonstrate how to convert a lowering system to a raising system with a 3:1 or 5:1 in-line with directional pulley.
5. Demonstrate how to construct a 3:1 and 5:1 mechanical advantage (MA) system.
6. Demonstrate how to construct a 3:1 and 5:1 pig rig.
7. Demonstrate how to convert a lowering system to a raising system with a 3:1 and 5:1 pig rig.

Rescue operations in structural rope rescue, in terms of victim extrication, can be accomplished by:

- Lowering victims to safety from their location (lowering operation)
- Lowering rescuers to the victims from above, then continue lowering to safety (lower/lower operation)
- Lowering rescuers to the victims from above, then raising them to safety (lower/raise operation)
- Raising rescuers to the victims, then lowering to safety (raise/lower operation)

These various main line operations can be easily accomplished with the use of a single RPM system. Agencies that prefer to continue using the Prerigged Dual RPMs depicted in the Low Angle Rope Rescue Operational Student Manual may continue using that system, but will need to become familiar with the single RPM configuration in order to receive a passing grade in this course. Some agencies may choose to modify the RPM system configuration somewhat differently than described in this or the Low Angle Rope Rescue Operational text to meet specific needs. Although these variables of system configurations would not normally be required to meet the scope of the Light level, it may be necessary for those agencies that possess a specific need in their jurisdiction. This is acceptable throughout this course as long as the system, lowering through an approved descender, changing over to a standard mechanical advantage (MA) system, and raising the load, is accomplished with one of the methods depicted in this text or the Low Angle Rope Rescue Operational text.

**\* The instructor will modify the RPM configuration to best meet local and regional needs.**



## Prerigged Dual RPM Systems

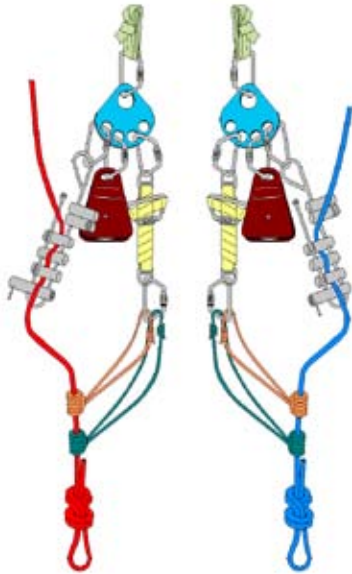


Figure 2:111 With Brake Bar Rack

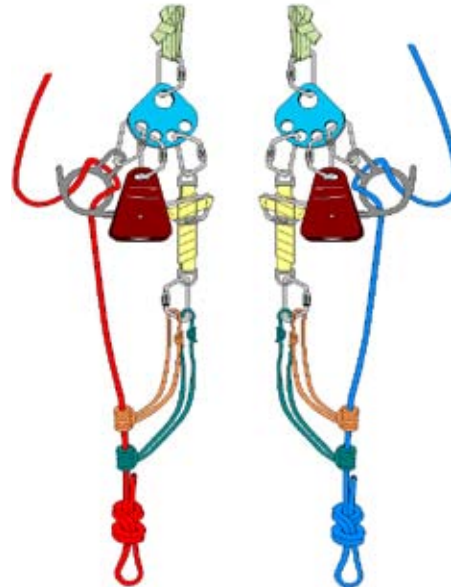


Figure 2:112 With Figure Eight Descender

- Although not specifically supported in this text, systems configured in this way are currently being used safely and efficiently in low- and high-angle rope rescue operations.
- Either RPM can become the belay/safety or main line side of the system based on site specifics and operational needs.
- The equipment required for the construction of the MA system is commonly carried in a pocket in one of the two rope bags, bagged separately, or preassembled and attached to a lifeline in a separate rope bag.

The rescuer has a few options to consider when selecting the type of main line rope rescue system. This chapter will show the following considerations for MA systems:

- Anchor positioning
- The in-line RPM system
- The in-line RPM system with a high change of direction
- The piggyback system



## Key Points Regarding Lower and Raise Operations

- Basic lowering operations and in-line MAs can be accomplished off the main line component.
- MA systems with piggyback systems require additional equipment and staffing.
- A Rigging Team Leader will direct the construction of the rope rescue system, command and control the Rigging Team, and report to the Rescue Group Supervisor. This is a key management position and requires a person with strong leadership skills and a high technical knowledge base of rope rescue operations.
- Anchor selection is also very important. Proper positioning of the anchors will ensure a safe and adequate working area for personnel and maximize the effectiveness of the MA system used.
- As its name denotes, the main line is the primary line in any rope system. The main line will be loaded during rappel and lowering or raising operations.

## Lowering Line Systems

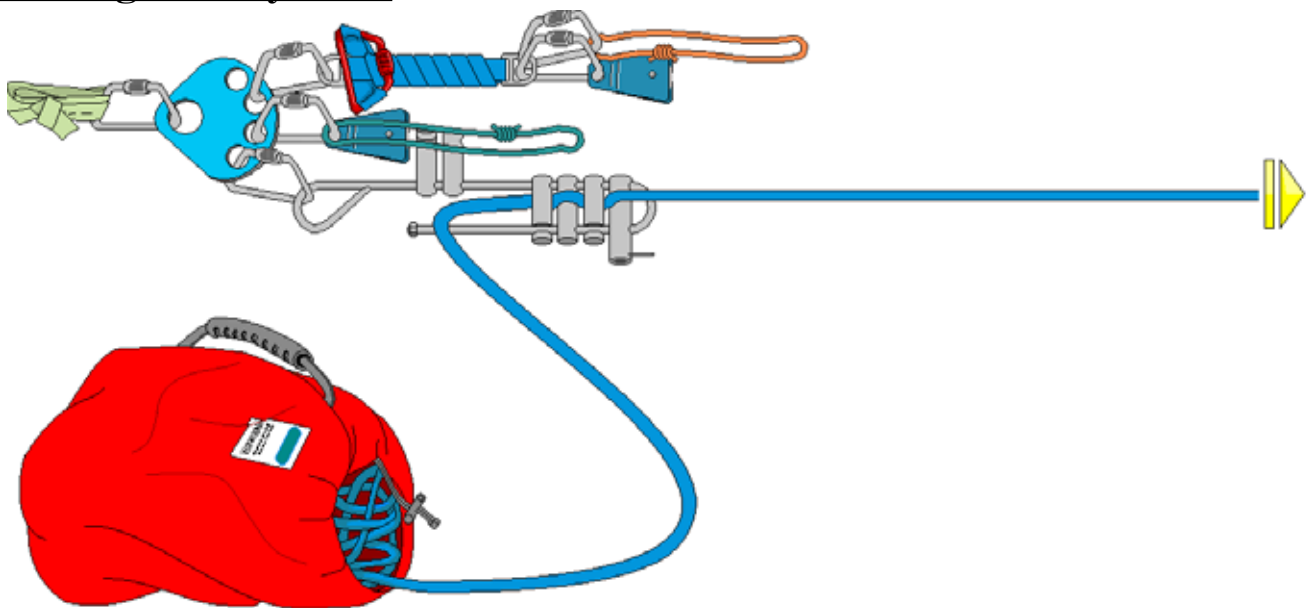


Figure 2:113 Lowering System with Brake Bar Rack

## System Staffing

- Lowering line tender(s) is **required**—tends descent control device (DCD; figure eight plate or brake bar rack).

## System Operation

- Brake bar rack, one- or two-person load: one tender adjusts bars as required.
- Figure eight plate, one-person load: one tender adjusts attachment as needed.
- Figure eight plate, two-person load: two tenders adjust attachment as needed.

## Lower to Raise Conversions

Once lowering operations are completed, the rescuer and victim most often must be pulled back up to a safe area. This is accomplished by using mechanical advantage or haul systems. In order to accomplish this, the rescuer must know how to convert a lowering system to a raising system. This initial conversion process will be the same for all MA systems in this course.

### Lower to Raise Conversion: 3:1 In-Line – RPM

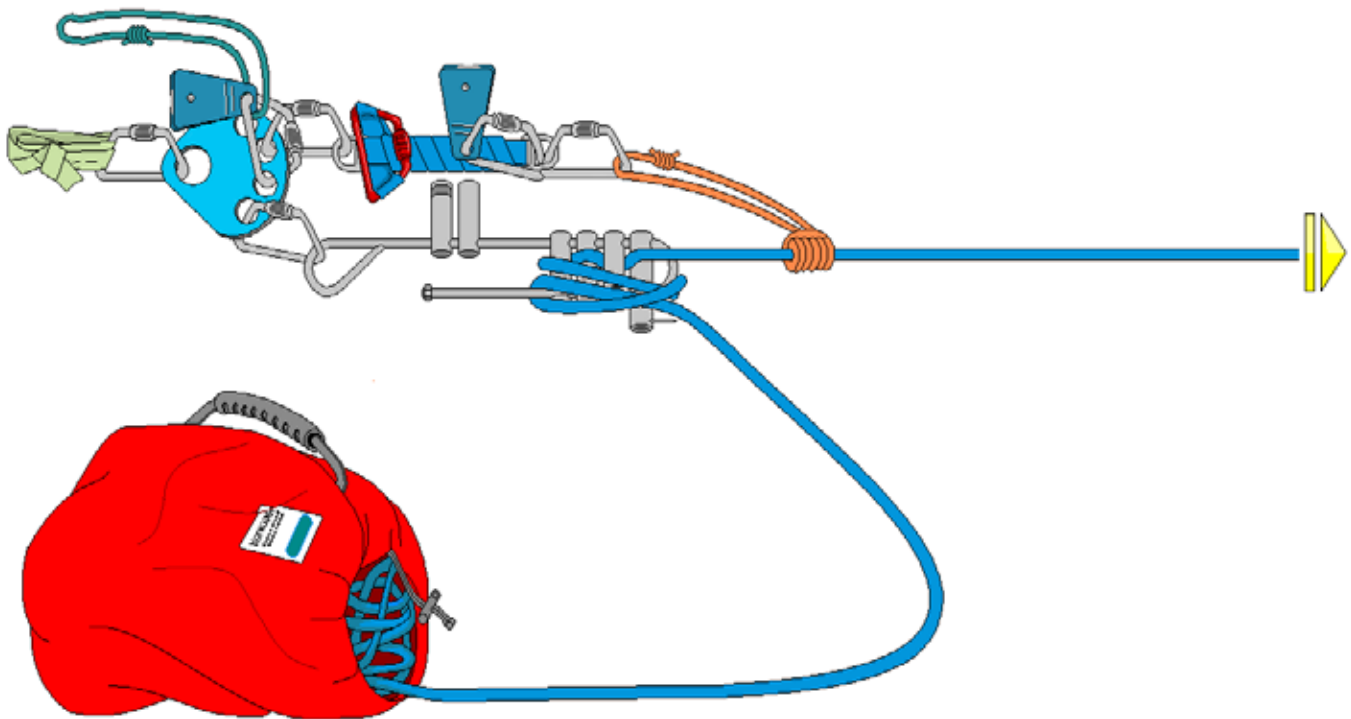


Figure 2:114

1. Tie off the DCD as shown in Topic 2-6.
  - Not needed if rescuer is on a safe level platform.
  - Not needed if the lowering line tender holds tension as prusik is attached.
2. Attach prusik to the line; one prusik is proven adequate as a brake to the main line.
3. Set the ratchet prusik.

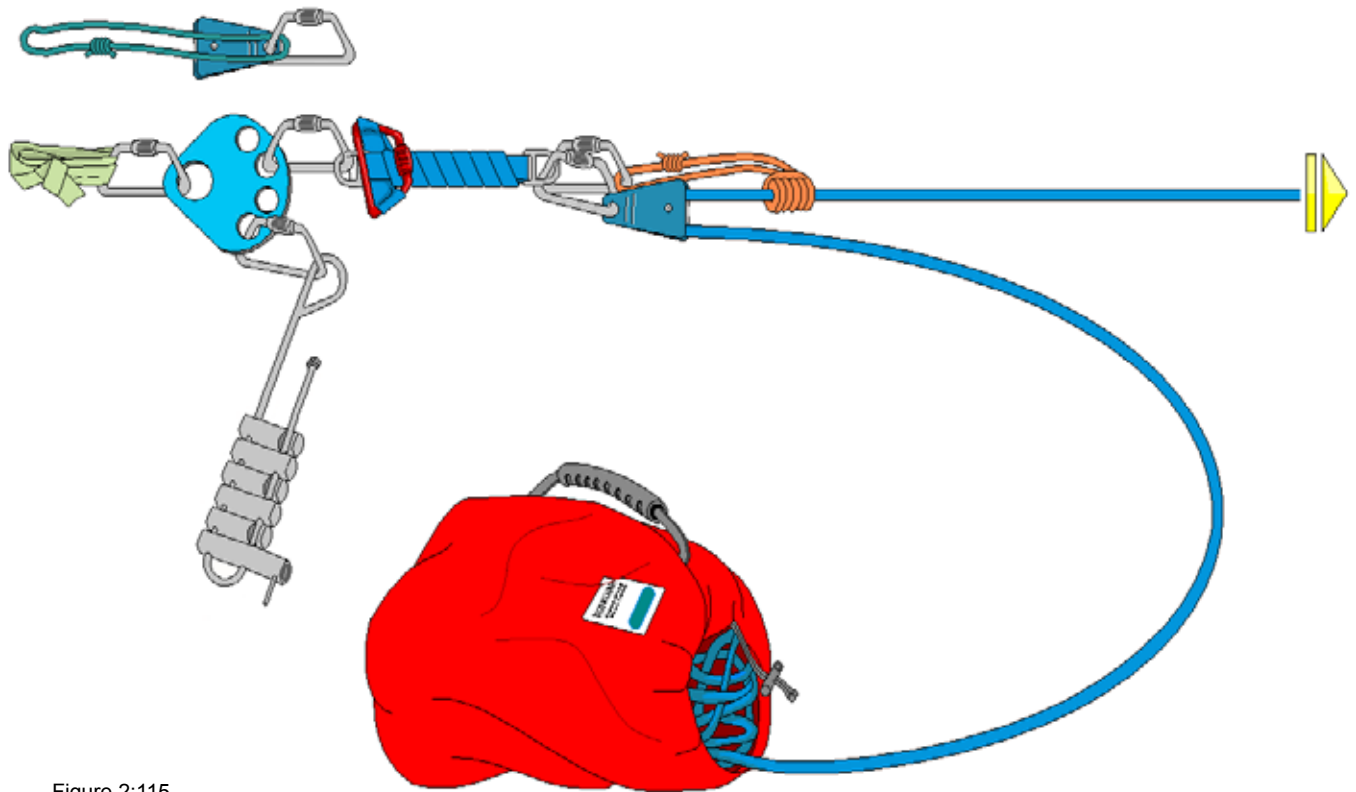


Figure 2:115

4. Remove the line from the DCD.
5. Install the line through the change-of-direction pulley on an independent carabiner.

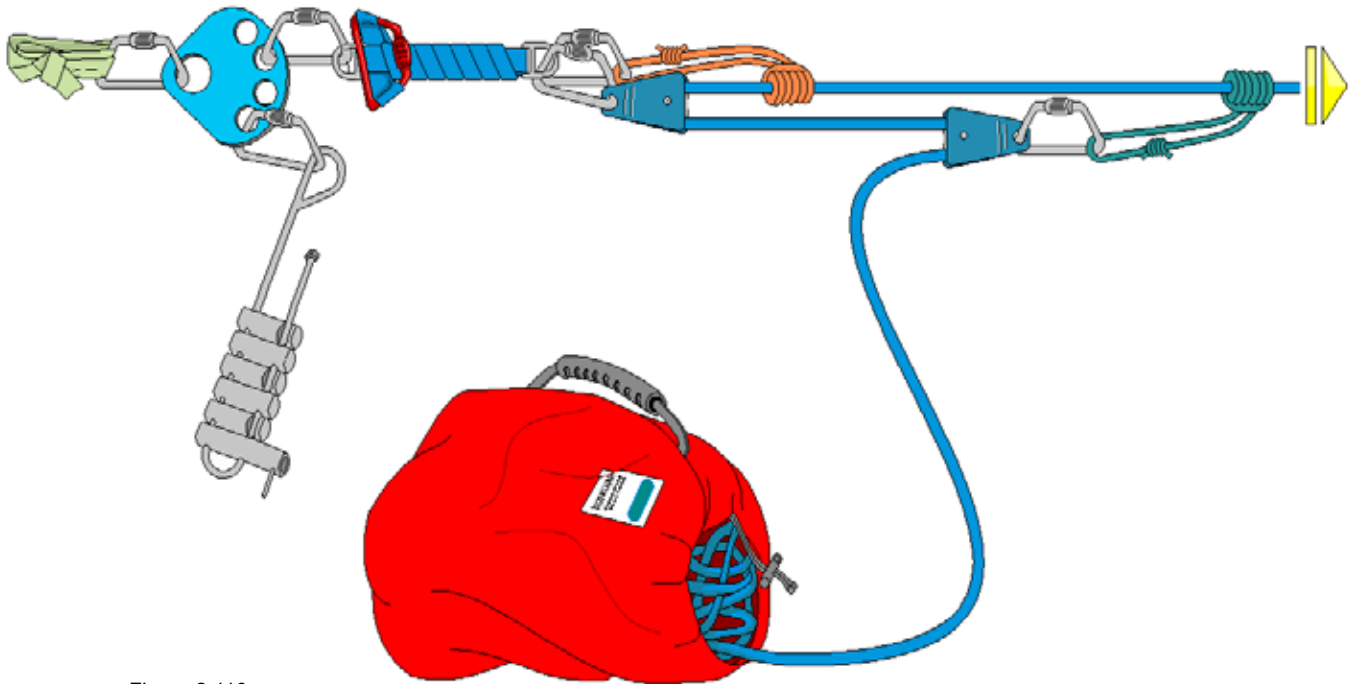


Figure 2:116

6. Attach haul prusik to line as close to the edge, the high directional, or other change-of-direction pulley as possible.
7. Install haul line in mechanical advantage pulley.
8. Connect mechanical advantage pulley to haul prusik with carabiner.

## Raising (MA) Systems

This chapter deals with the following variations of the MA systems:

- 3:1 and 5:1 in-line MA systems
- 3:1 and 5:1 MA systems with a directional change pulley(s)
- 3:1 and 5:1 piggyback systems

## System Staffing

### Haul Team

- Use minimum of three and maximum of four haulers on a 3:1 MA system.
- If adequate staffing is not available, increase MA to 5:1.



# RESCUE SYSTEMS 1

## Basic Rescue Skills

### Topic 2-7: Lower and Raise Main Line Systems



## Key Points Regarding Raising Operations

### *Ratchet/Main Line Brake*

There have been several different terms for the prusik attached to the main line and anchored at the end of the LRD, such as ratchet cam, ratchet prusik, main line brake, and progress capture cam, to name a few. The term “ratchet” describes the action of allowing the rope to travel in one direction but not allowing it to travel in the other direction. The term “brake” is the same as in a moving vehicle—it stops a moving line. The phrase “progress capture cam” is similar to the term “ratchet”; it describes the movement of the line in one direction without allowing the rope to travel back in the other direction. The other age-old question in regard to this device is one prusik or two. Since this application of the prusik is to hold the line while it is under tension so the Haul Team can reset the MA system and **not** to arrest a falling load, only one prusik is required. Some agencies choose to use two prusiks here in order to minimize the confusion between the number of prusiks on the main line and the number on the belay/safety line during rigging. The next decision is where to locate the change-of-direction pulley in the MA system. For most rescuers today, the term “ratchet” implies that the pulley is attached to the end of the LRD and tends the prusik. When the pulley is located at the anchor plate, the system is no longer self-tending nor is the prusik considered to be ratcheting. If this is the case, the prusik *must* be tended by a rescuer because the distance is too great between the pulley and the prusik, which creates an excessive amount of slack in the main line if released. This text will refer to the prusik as a “ratchet prusik” that will be tended by the pulley that is attached to the end of the LRD, as shown previously in this chapter.

### *Haul Team*

The Haul Team will typically grasp the line and walk in a controlled manner to apply force to the system. In situations of limited hauling space, the team will haul using the hand-over-hand method.

## 5:1 In-Line – RPM

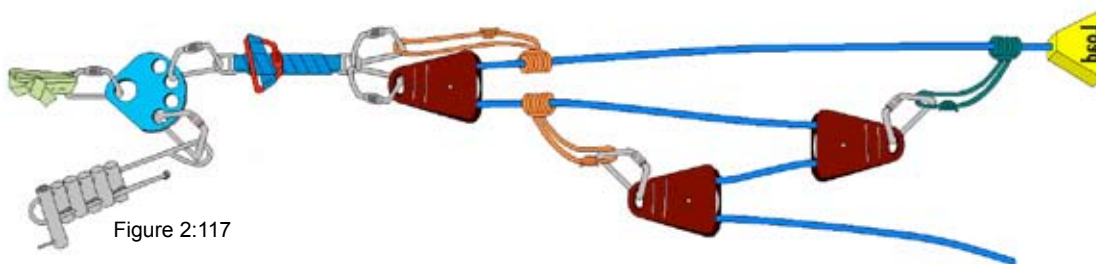


Figure 2:117

1. Attach haul prusik to line on haul side of change-of-direction pulley on RPM.
2. Install haul line in second mechanical advantage pulley.
3. Connect second mechanical advantage pulley to haul prusik with carabiner.

## **3:1 or 5:1 In-Line Mechanical Advantage System**

If the distance between the main line anchor and edge is adequate, an in-line mechanical advantage system will be used. Adequate distance will provide the Haul Team a safe area to work in-line toward the incident. This distance must also be long enough to minimize the number of resets necessary to complete raising operations. Keep in mind how much rope will be used to reach the victims; this will determine your maximum setback.

## **3:1 or 5:1 In-Line with Directional Pulley**

Often in structural rope rescue incidents, there is inadequate working area for an in-line mechanical advantage system. In these situations, a directional change pulley is used to change the direction of the main line from an adequate working area toward the opening or point of departure. When space provides, the distance between the main anchor and the change-of-direction anchor should be approximately one-half the length of the unused rope in the bag for a 3:1 mechanical advantage system or one-third the length of unused rope in the bag for a 5:1 mechanical advantage system.



Figure 2:118 RPM 3:1 MA system with change of direction pulley



Figure 2:119

1. Anticipate the need for the change of direction prior to rigging for lowering.
2. Select anchor for the directional change and attach change-of-direction (COD) pulley.
3. Select anchor for the RPM system, attach, and rig for lowering.
4. Lower through the COD.
5. Change over to raising system, 3:1 MA with COD.
6. Increase MA to 5:1, if necessary.

## High Directional Pulley

It doesn't take rescuers long to realize how advantageous a high-directional change pulley can be once they have lowered and raised a few loads over a low point of departure. The question is, is it worthwhile to create the high anchor point? This question can be answered by determining the type materials in the overhead structure and by the number of lowers and raises required to accomplish the mission. If there are only one or two victims, the rescue may be completed by the time the necessary tools arrive to create the anchor. In light-frame constructed buildings this can be accomplished simply by breaching the ceiling material directly over the port of entry/exit and wrapping the ceiling joist with an anchor sling and attaching a pulley. This COD operates just like the COD described above except that it provides a means of keeping the main line overhead while entering and exiting. This saves the backs of the entire rescue team from having to pull the victims over the sill or edge.

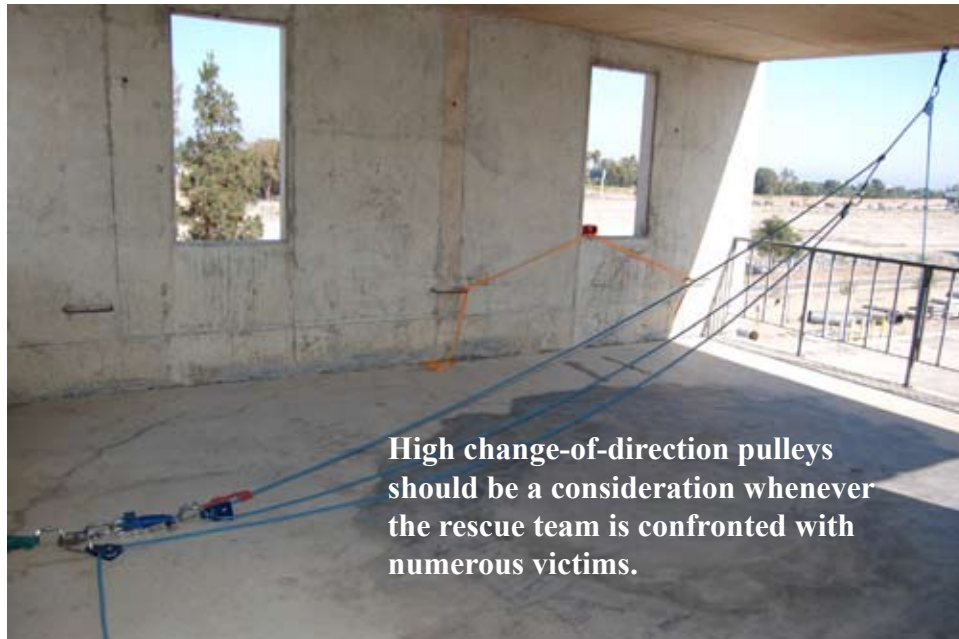


Figure 2:120

## Key Points for Anchor Selection

- ❑ The setback from anchor will be determined by your working area, type of mechanical advantage used, and the amount of line used.
  - Consider your minimum working space. Is it enough room for the rescuer, litter, RPM, and their operation?
  - Consider your maximum working space. It is dependent on the rope length and available area.

## Piggyback Systems

### Introduction

In long lowering operations, most of the main line can be used in the primary lower. This will not leave enough line to construct an in-line mechanical advantage system. In these situations, a “piggyback” or “pig rig” mechanical advantage system is used. In this course, two options will be presented: a 3:1 and a 5:1 piggyback system. As with in-line systems, the 5:1 will build off the 3:1 rigging.



## 3:1 Pig Rig

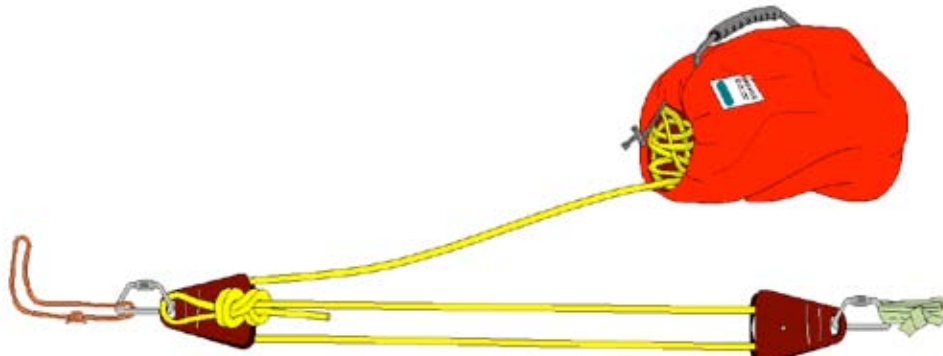


Figure 2:121 Assembled Pig Rig

## 5:1 Pig Rig

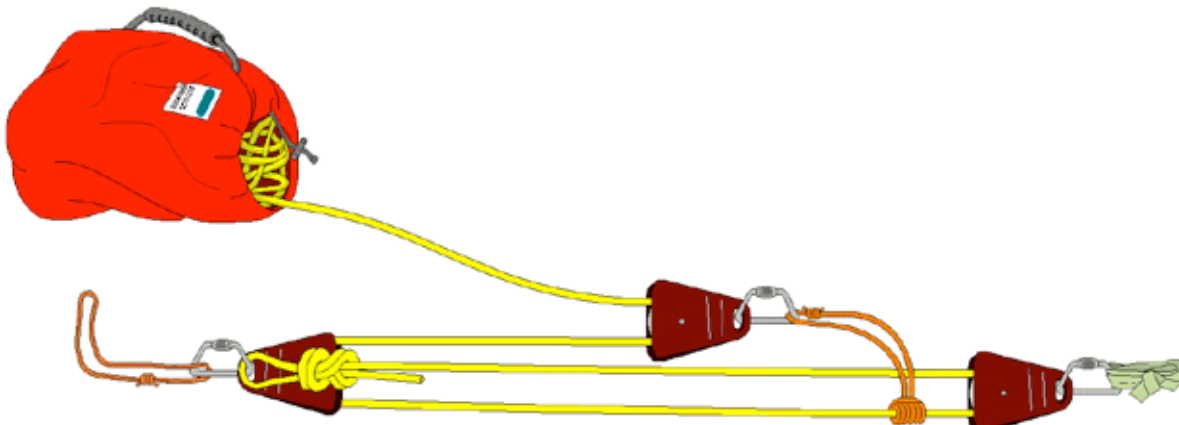


Figure 2:122 Assembled Pig Rig

## Key Points

- ❑ A piggyback system adds another line to the main line, much as a block and tackle does. This added line will provide the mechanical advantage needed for raising operations and is often referred to as the haul line, MA line, or pig line.
- ❑ The pig rig concept allows the first-in companies to fully extend the first two lines (belay/safety and main) to the incident. It also allows a second-in company to construct, extend, anchor, attach, and operate the mechanical advantage system.
- ❑ Many teams carry a preassembled pig rig in a third rope bag. This can be quickly extended and attached to the main line, reducing setup time for the raising system.

## Lower to Raise Conversion: 3:1 Pig Rig

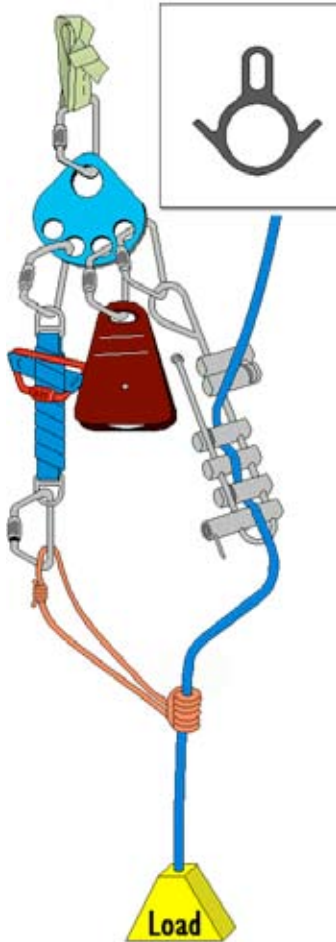


Figure 2:123 Lower with Load

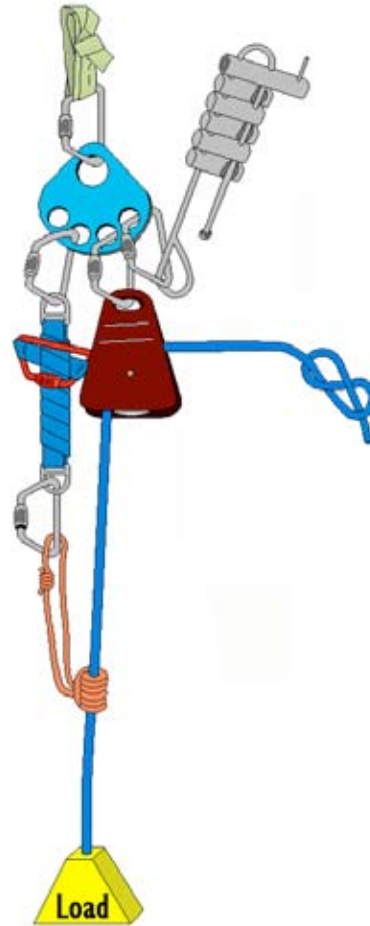


Figure 2:124 Main line Brake with Load

1. Tie off the DCD as shown in Topic 2-6.
  - Not needed if rescuer is on a safe level platform.
  - Not needed if the lowering line tender holds tension as prusik is attached.
2. Attach the prusik to the line.
3. Set the ratchet prusik.
4. Remove the line from the DCD.
5. Install line through change-of-direction pulley.
6. Place line toward secondary anchor.

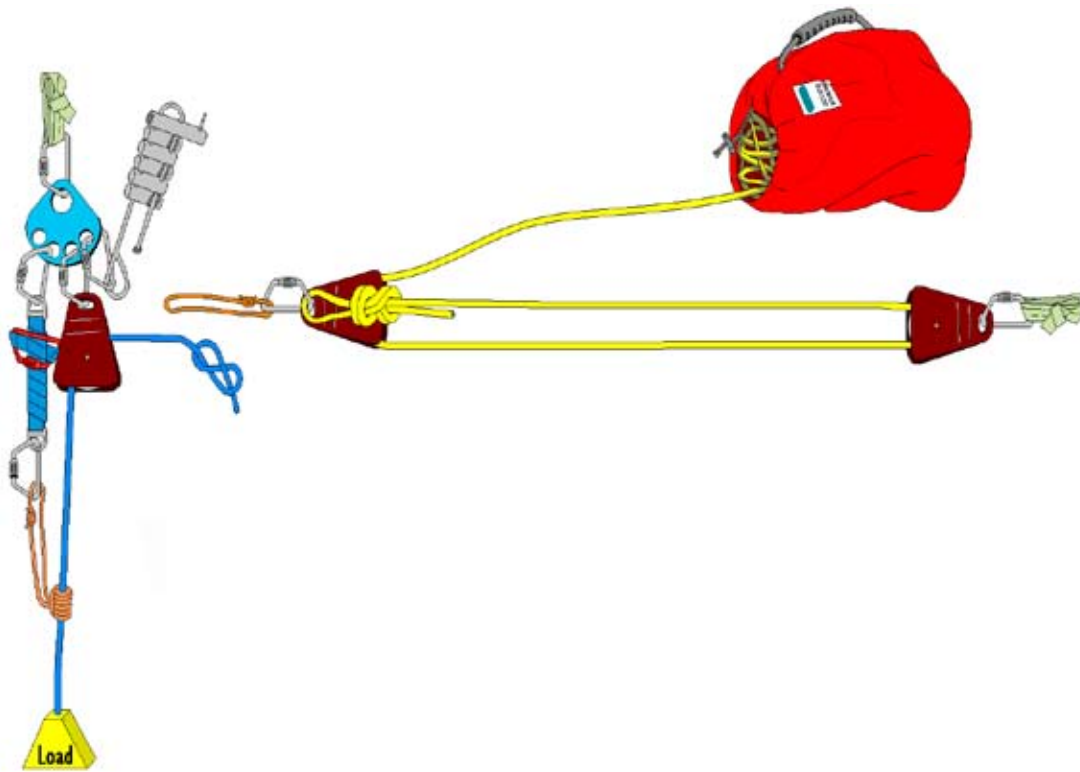


Figure 2:125

7. Construct the 3:1 pig rig or lay out preassembled pig rig.
8. Extend the 3:1 pig rig from the secondary anchor to the main line anchor.
9. Anchor the 3:1 pig rig using an anchor sling to attach to the secondary anchor. Always maximize the distance between these two anchors in order to reduce the number of resets during hauling (raising) operations. In a 3:1 system, that distance will be just under one-half the length of the haul line.

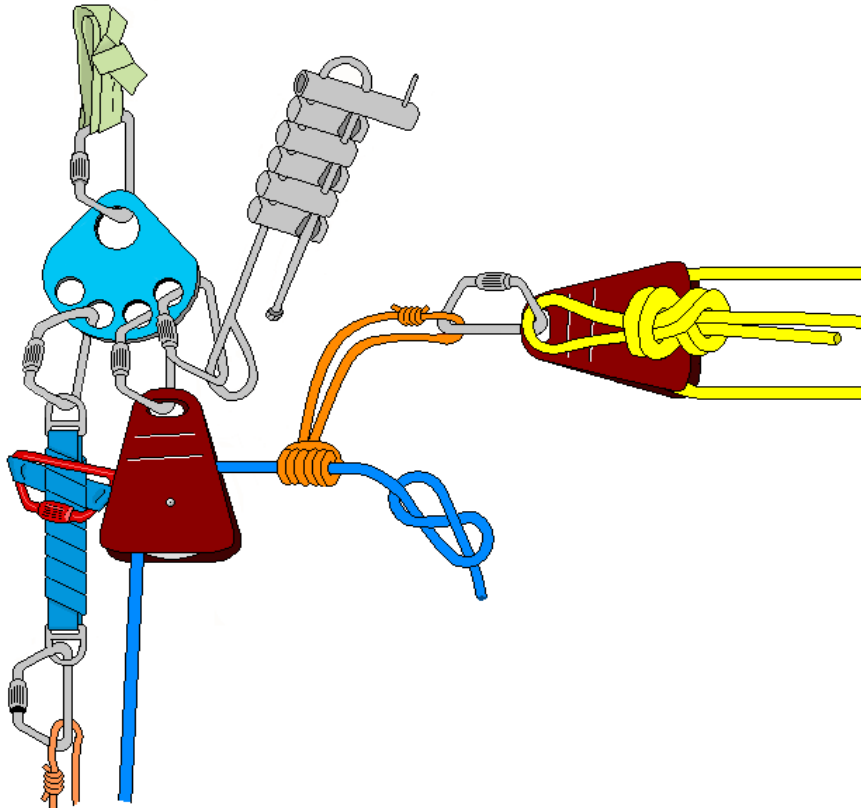


Figure 2:126

10. Attach the 3:1 pig rig to the main line using the prusik already attached to the pig rig.
11. System is in “Ready” position.

## Lower to Raise Conversion: 5:1 Pig Rig

1. Follow steps for the 3:1 pig rig.
2. Construct the 5:1 pig rig or lay out preassembled 3:1 pig rig and convert to a 5:1.

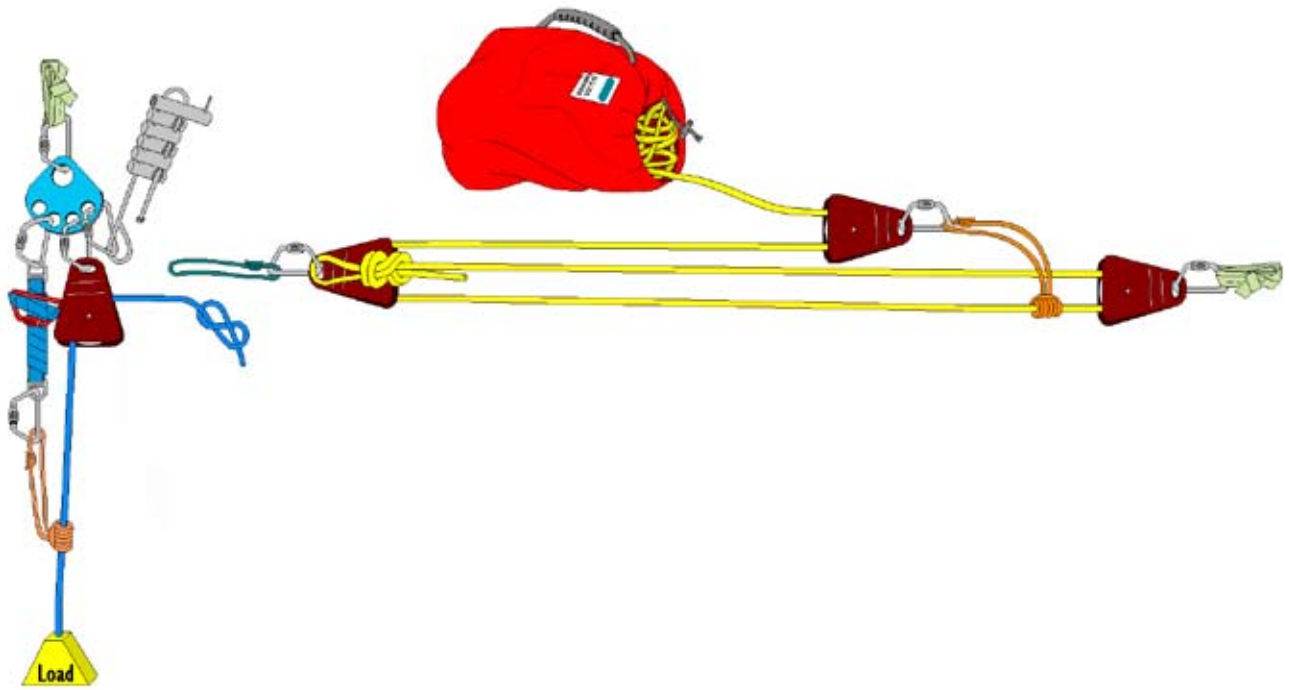


Figure 2:127

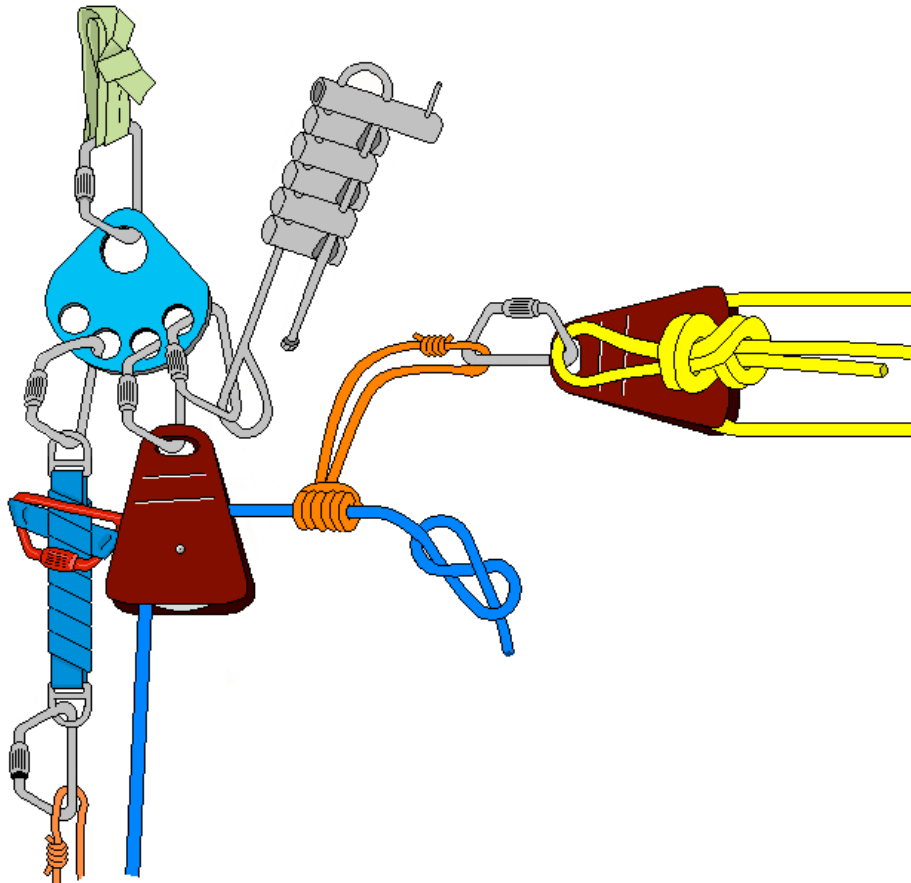


Figure 2:128 Construct Pig Rig



---

# RESCUE SYSTEMS 1

## Basic Rescue Skills

---

### Topic 2-7: Lower and Raise Main Line Systems

---





# RESCUE SYSTEMS 1

## Basic Rescue Skills



### Topic 3-1: Introduction to Lifting and Moving Heavy Objects

## Topic 3-1: Introduction to Lifting and Moving Heavy Objects

**Scope:** This chapter serves as an introduction to Lifting and Moving Heavy Objects.

**Terminal Learning Objective (TLO):** At the end of this chapter, the student will be familiar with the unit objectives in order to develop the proper size-up, techniques, and safety considerations when attempting to lift, roll, or move heavy objects. Heavy objects are unforgiving and will cause severe, permanent injuries or death when performed incorrectly.

**Enabling Learning Objectives (ELO):**

1. Describe tool types, capabilities, and safety considerations when lifting heavy objects.
2. Describe three different types of jacks, their operating principles, and safety precautions.
3. Describe the appropriate personal protective equipment, safety precautions, and medical precautions.
4. Describe rescue team positions.
5. Describe determining the weight of structural components.
6. Describe moving heavy objects.
7. Demonstrate raising, stabilizing, rotating, and lowering a single heavy object.
8. Demonstrate raising, stabilizing, moving, and lowering multiple heavy objects.
9. Demonstrate raising, stabilizing, moving, and lowering multiple heavy objects while safely managing and extricating a victim from under the objects.

### **Introduction**

Long ago, man learned that work done by machine is easier than work done by muscle power alone. One of the most common tasks encountered by a rescue team in a structural collapse is to lift and possibly move a heavy object in order to reach or extricate a victim.

This task may have to be performed without the aid of heavy equipment. Cranes, forklifts, backhoes, and other equipment normally used to move large, heavy objects might not be available. Equipment may not be able to reach the site due to infrastructure collapse, large debris piles, or remoteness of the incident. In some cases, heavy equipment cannot be used because the movement or operation of that equipment may further endanger the victim or rescuers by causing further collapse.

Simple hand tools can be used to create tremendous mechanical advantage to lift, lower, and move large loads safely. Those same loads can be moved with relative ease by reducing friction between the load and the surface it is to be moved across. Basic methods of building crib beds can be used to stabilize heavy objects.

### **Types, Capabilities, and Safety Considerations for Tools Used When Lifting Heavy Objects**

#### **Lever**

The simplest of machines is a lever. A lever is a rigid bar, either straight or bent, that is free to move on a fixed contact point called a fulcrum and works by transferring force from one place to another. There are three classifications of levers determined by the location of the fulcrum as it relates to both the load and the force.



## Class 1 Lever

The **Class 1 lever** gives the greatest mechanical advantage. A load is located at one end of the lever and the lifting force is placed at the other end, with a fulcrum located between the two. Crowbars and pry bars are examples of Class 1 levers. **They are most useful for lifting objects vertically.** The first-class lever changes the direction of the force. Here the force is applied downward while the load moves up.

The **mechanical advantage** can be calculated by comparing the distance between the load and the fulcrum to the distance between the fulcrum and the force.

If the length of the lever is three times as long on the force side of the fulcrum as on the load side, the lever has a 3:1 mechanical advantage. Thus, if you have a 3-pound load to lift and a 3:1 lever, it will take 1 pound of force to lift the load.

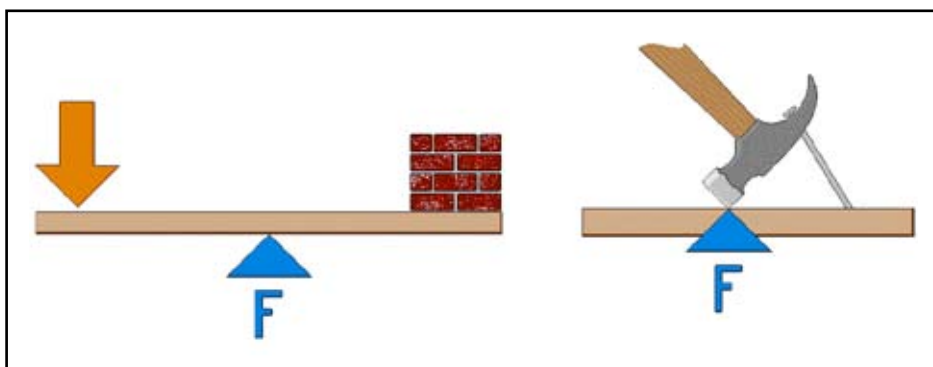


Figure 3:1 Class 1 Lever

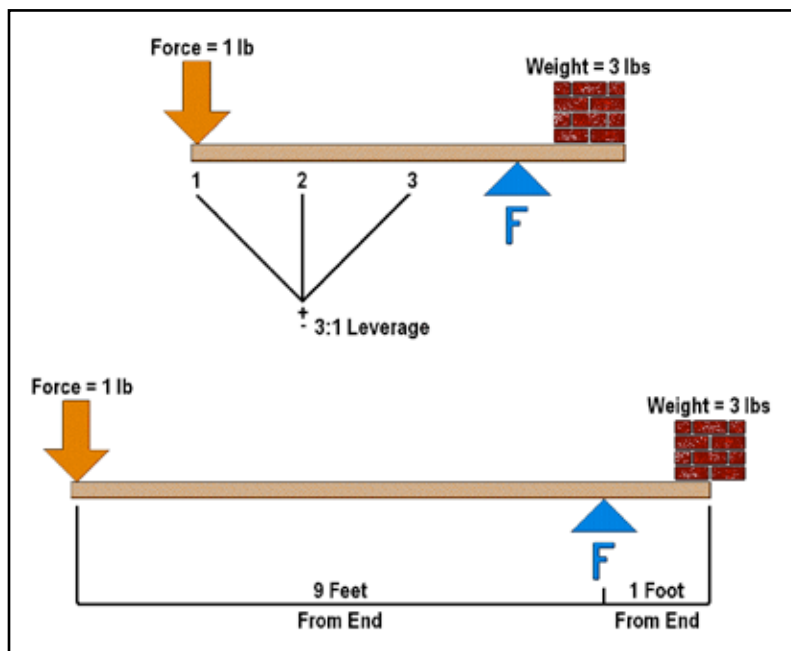


Figure 3:2 : Mechanical

## *Class 2 Lever*

The **Class 2 lever** is the next most useful and efficient lever. It consists of a fulcrum at one end of the lever, a load in the middle, and a force on the other end. Wheelbarrows are a type of second-class lever. **This type of lever is useful for moving objects horizontally.**

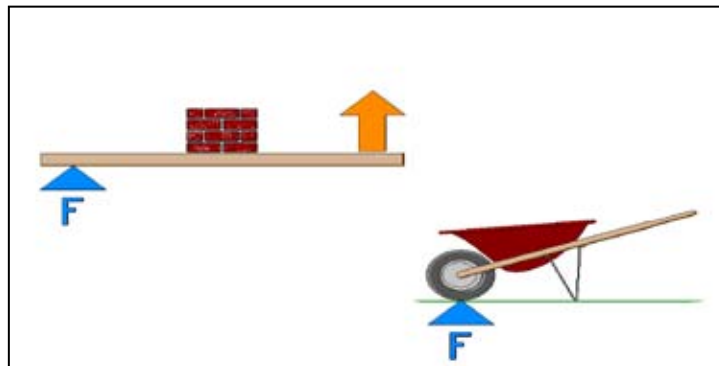


Figure 3:3 Class 2 Lever

## *Class 3 Lever*

The **Class 3 lever** is used when **force may be sacrificed for distance**. It places a load on one end, the fulcrum on the opposite end, and the force in the middle. Shovels and brooms are types of third-class levers commonly used for light debris removal. Third-class levers are not used for lifting or moving heavy objects.

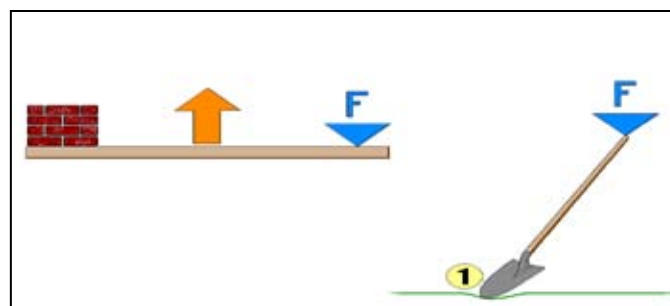


Figure 3:4 Class 3 Lever

When using a lever, considerations must be given to the stability and strength of the fulcrum and the surface upon which the fulcrum rests. The fulcrum and the foundation it rests on must be capable of holding the weight of the load to be lifted.



# RESCUE SYSTEMS 1

## Basic Rescue Skills



### Topic 3-1: Introduction to Lifting and Moving Heavy Objects

## **Types of Jacks and Their Operating Principles**

Jacks are compound machines. A compound machine combines two or more simple machines to create more mechanical advantage than a simple machine can create by itself. Mechanical advantage is created through manual, mechanical, pneumatic, and/or hydraulic means.

Lifting and moving a heavy object is labor and equipment intensive. You may be the first crew on scene or working in an area apart from other crews and have a limited amount of personnel and equipment. Therefore, it is imperative to know your equipment and how to accomplish your objective as efficiently as possible.

Typically, one person can lift about 1,500 lbs with a class 1 lever. It would take six people with bars to lift 9,000 lbs. The US&R Type-3 (Light) Operational Level (Minimum Equipment List) requires a hydraulic jack (5 ton minimum) to be carried as part of the equipment cache. One person with a 5-ton jack has the ability to lift 10,000 lbs. Jacks have a wide range of lifting capacities, anywhere from 2 tons to more than 50 tons.

When using bars to lift an object, you typically have to stop and reset the fulcrum every 2" to 4". With a jack, the need to stop and reset the fulcrum is reduced. A jack can lift an object anywhere from 7" to 4' before there is a need to stop the lift. This all depends on the size and type of jack.

- Screw jack: operates on the principle of the incline plane theory plus a lever
- Hydraulic jack: operates on the theory of hydraulic force being applied to a ram by a lever
- Mechanical jack
  - Operates on the Class 1 lever theory
  - Applies when using jacks for raising heavy loads

## **Safety Precautions**

- Keep jacks perpendicular to both the load and the surface the jack is resting on.
- Wood headers can be placed between the load and jack to help distribute force and minimize the possibility of the load slipping off the jack.
- Crib the load as it is raised.
- When using multiple jacks, raise them together and at the same speed.
- When raising one side of the load, be sure the opposite side or end of the load is stable.

## **Safety**

### **Personal Protective Equipment**

When lifting heavy objects, basic safety equipment (long pants and shirt, gloves, steel-toed safety boots, helmet with chinstrap, and ANSI-approved eye protection) must be worn at all times. This basic complement of equipment will protect the rescuer from minor cuts, abrasions, and contusions. Small concrete chips and associated debris can fracture off at very high velocities during operations and cause serious injury to unprotected rescuers.

### **Safety Rules and Considerations**

Lifting heavy objects is a slow and tedious process. Great care must be taken to prevent sudden movement or shifting of the load. If the operation is taking place in a structure damaged by earthquake or explosion, the last thing you need is several tons of heavy material sliding sideways or dropping several inches. This dynamic loading would place tremendous strain on an already unstable structure.

## Crib and Stabilize as You Lift

Use crib beds and wedges as stabilizers to prevent the sudden or accidental movement of the load. Never place any body part under unsupported loads.

## Lift Increments

Lift in short controlled increments, approximately 2" to 4" at a time, depending on the fulcrum height and distance and the size of the wedge used to support the lift. To prevent unwanted horizontal movement of the object, lift in small increments. Use 2x4 or 4x4 cribbing for stabilizing and as fulcrum points. If the fulcrum height is greater than 2" or too close to the load, relative to the purchase point, the movement of the object may be horizontal as well as vertical. Horizontal movement will cause crib beds to collapse and may cause serious injury to rescuers and victims.

## Lifting Techniques

Use proper lifting techniques and body mechanics. Poor lifting technique can cause strains, sprains, and spine-related injuries. Use proper body mechanics when working with heavy loads. Keep your legs bent, back straight, and head/face away from pry bar and lift with your legs to prevent injuries.

## Collapse Size-Up

Use the six-sided approach when sizing-up a collapse incident. Identify the type of construction, nature of collapse, and collapse configuration. Identify void spaces and potential location of victims. Develop an incident action plan based on number and locations of victims. Remove surface victims first, and then work from lightly to heavily entombed victims. Secure adequate materials and resources to implement and support action plan. Continuous evaluation of planned lifts, moves, and maintenance of structural stability is critical to preventing secondary collapse.

## Lift, Hinge, and Cribbing Points

The lifting points are where fulcrums can be built and lifting crews are positioned safely to perform their job. The hinge point or points are where the object will hinge opposite the lift force. Crib beds opposite the lifting points commonly become hinge points for the lift. On initial lifts, the hinge point may be the ground surface or another stabilized object. Hinge points will often indicate the direction the load may shift. Cribbing points indicate where the crib beds will be built to support the load and/or provide stable hinge points. Crib beds need to be built in areas that will support the load adequately and not block access/egress to the victims.

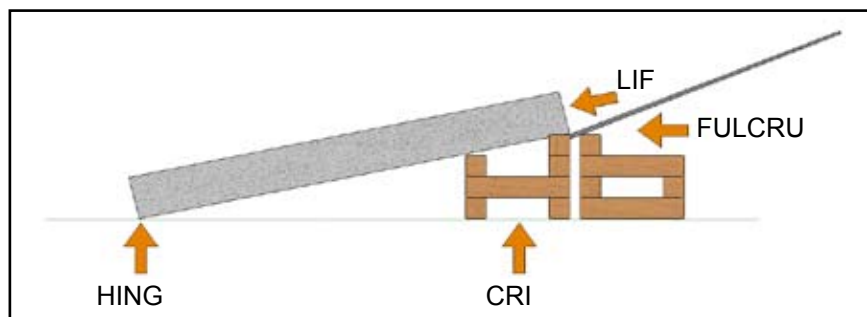


Figure 3:5 Lift, Crib, Hinge Points



# RESCUE SYSTEMS 1

## Basic Rescue Skills



### Topic 3-1: Introduction to Lifting and Moving Heavy Objects

#### **Medical Precautions**

Special precautions must be taken with crush injuries that are common to these kinds of rescue operations. Make sure that proper medical care is given and advanced care is available before removal of a heavy object from a victim.

#### **Group Dynamics**

A group may consist of many very different types of people. In order for a group to come together, it must commit to a goal or objective. Constant feedback and direction must be given for a group to be effective.

#### **Teamwork and Leadership**

Teamwork is critical to a safe and efficient operation and requires a strong leader. Leaders either exist by position or are established during a given situation. The leader sets the tone of how well the objective is met. Leadership involves:

- Developing a plan of action and implementing the plan by coordinating work through others
- Adapting and overcoming problems
- Ensuring overall safety of the operation and personnel involved

#### ***Rescue Team Position Descriptions***

##### ***Squad Leader***

- Develops and implements the action plan
- Calls commands
- Maintains safety

##### ***Assistant Squad Leader***

- Fills this position when a squad of 10 to 12 students is divided in two to form "A" and "B" squads
- Assists the Squad Leader with developing and implementing the action plan
- Is also responsible for squad safety

##### ***Safety Officer (If the squad is large enough, the squad leader can designate a Safety Officer.)***

- Maintains overall safety of squad members
- Monitors stability of heavy objects and crib beds
- Can terminate any operation deemed unsafe

##### ***Bars***

- Operate pry bars to raise, hold, lower, and move heavy objects

##### ***Cribbers***

- Construct crib beds to support and stabilize heavy objects

##### ***Logistics (Feeders)***

- Supply Cribbers and Bars with materials to construct crib beds or fulcrums



# RESCUE SYSTEMS 1

## Basic Rescue Skills



### Topic 3-1: Introduction to Lifting and Moving Heavy Objects

#### ***Standard Commands***

Verbal commands are used to prevent rescuer injury and develop safe, deliberate movement of heavy objects. Clear text should be used. The following are commonly used commands for heavy object operations:

Squad Leader	“READY TO RAISE.” “READY TO LOWER.” “READY TO MOVE OBJECT.” All assigned positions will respond “READY.”
Squad Leader	“RAISE.” “LOWER.” “MOVE OBJECT.” The Bars will take action as commanded.
Squad Leader	“HOLD.” This command is used to hold the object until the Cribbers have completed the crib beds to support the load.
Cribbers	“CRIBS SET.” This states when the crib bed is completed.
Squad Leader	“LOWER OBJECT.” The Bars will lower the object until it is supported solely by the crib beds.
Any Squad Member	“STICK.” This is an emergency command that can be given by any squad member and is an immediate request for the Cribbers to support the object. The Bars may have lost purchase point or control; presence of undesired movement or instability.
Cribbers	“CRIBS SET.” This indicates the load is secure.

A heavy-lift operation takes a lot of people and a lot of equipment. If the team is to be successful, all persons must work within their assigned positions and follow commands as given to maintain safety.

#### ***Safety Officer***

This position is responsible for:

- Ensuring that personnel are clear of the object while it is being lifted, held, or lowered
- Ensuring that proper safety equipment is donned by all
- Watching for undesired load movement and load stability

Each lifter should be supported by a Cribber who builds crib beds under the load to prevent any unwanted downward movement. Each crib bed builder (Cribber) should be supported by a Feeder who keeps a supply of crib building materials within arm’s reach.



# RESCUE SYSTEMS 1

## Basic Rescue Skills



### Topic 3-1: Introduction to Lifting and Moving Heavy Objects

Care must be taken to build stabilizing structures so the load is supported to the ground through solid wood contact.

#### **Determining the Weight of Structural Components**

A rescuer will need to estimate the weight of an object to determine the number of crib beds needed to support the load and the equipment required to lift load.

#### **Weights of Common Building Materials**

Weights are recorded as either pounds per cubic foot (PCF) or pounds per square foot (PSF).

Concrete	150 PCF
Masonry	125 PCF
Wood	35 PCF
Steel	490 PCF
Concrete/Masonry Rubble	10 PSF per inch (of thickness)

#### **Weights of Common Building Construction**

Concrete floors	90-150 PSF
Steel beam with concrete-filled metal deck	50-70 PSF
Wood floors	10-25 PSF
Floors with thin concrete fill	25 PSF or more
Wood or steel interior walls	Add 10-15 PSF each floor level
Furniture and contents (more for storage, etc.)	Add 10 PSF or more each floor level

#### **Load Stabilization, Crib Bed Capabilities, and Construction**

The purpose of crib beds is support and stabilization. They should be built beneath the load as it is lifted. There are many materials that can be used for cribbing, but the best and most versatile is 2x4 and 4x4 construction-grade lumber. Douglas fir and Southern pine are the most commonly used and available species. Both species are rated at 500 psi (pounds per square inch) perpendicular to the grain. A finished 2x4 or 4x4 has an actual flat surface size of 3.5".

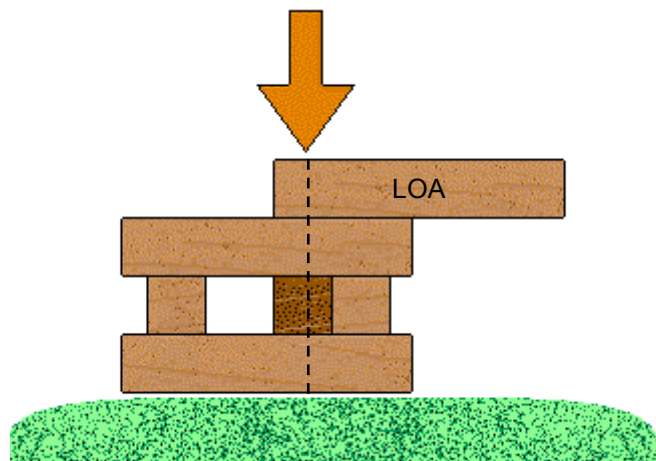
Example:

1. One 3.5" piece of cribbing overlapped perpendicular with another 3.5" piece of cribbing = 12.25 square inches of wood surface contact.
2. 12.25 square inches x 500 psi = a load-carrying capacity of 6,125 pounds.
3. Rule of thumb: a 4x4 crib bed has approximately a 6,000-pound capacity for each overlapped contact point bearing load.

4. 6,000 pounds multiplied by number of contact points = load capacity.
5. Box crib: four contact points x 6,000 = 24,000 pounds.
6. Cross-tie crib: by adding one more piece of cribbing to each layer, the number of contact points is increased to 9 and the load-carrying capacity of the crib bed increased to 54,000 pounds.
7. A box crib of 6x6 lumber has a capacity of 60,000 pounds.

Materials other than wood can be improvised to support loads, but can be subject to sudden crushing and uncertain failure strengths. Wood tends to slowly fail with lots of noise. This warns rescuers of the impending failure.

To maximize crushing failure, the tails of each layer of cribbing should extend approximately its dimension past the layer of cribbing below. When the crib bed is loaded to capacity, it will crush uniformly, creating saddles similar to Lincoln Logs, preventing pieces from squirting out. This method works only if the load remains relatively square to the ground. If the object is not square to the ground, the cribbing tails or ends will be loaded, causing the crib bed to become unstable and reduce its load-carrying capability.



Wood-to-Wood Contact from Load to

Figure 3:6 Cribbing

When cribbing to sloped surfaces, it may be necessary to place the ends of each piece of cribbing flush to the layer below to increase crib bed stability. When cribbing to sloped surfaces, add additional pieces of cribbing to each layer. The additional interior pieces of cribbing can be adjusted or floated from side to side to increase the capacity and improve the load path. In Figure 3:6, the interior piece of cribbing is shaded to identify its adjustability with the crib bed.

The first layer of a crib bed that is constructed on dirt, asphalt, or any suspect surface should be solid to spread the load and maintain stability.

There are two basic rules that should be followed when determining the allowable height of a crib bed and maintaining load stability:

1. Never build a crib bed higher than three times the length of cribbing in use. To determine the cribbing length in use, measure the shortest side of crib bed from outside of contact point to outside of contact point.
2. This rule is based on the ratio of contact points carrying load (corners of crib bed) to maximum crib bed height.





# RESCUE SYSTEMS 1

## Basic Rescue Skills



### Topic 3-1: Introduction to Lifting and Moving Heavy Objects

The contact point to height ratios are as follows:

4 contact points	3 x length of cribbing
2 contact points	1.5 x length of cribbing
1 contact point	1 x length of cribbing

The height ratios are approximate and need to be reduced due to slopes and nature of incident, i.e., earthquake aftershocks, settling, etc.

Precut cribbing in 18" to 24" lengths can be stockpiled ahead of time. Prior arrangements and agreements with local lumberyards to supply rescue teams with bulk lumber in order to cut cribbing into desired lengths is a good idea. This prevents the need to stockpile large amounts of materials ahead of time. During a large-scale disaster, rescuers may be required to reconnoiter the area and use materials as located, i.e., construction sites, collapsed structures, fences, etc.

Wedges: 2x4x12" and 4x4x18" wedges are used to support, stabilize, and shim a load as it is lifted. The wedges need to be inserted as the load is raised. This is to prevent the load from dropping if a purchase point fails or if a rescuer cannot hold the load. Insert a full-size 4x4 piece of cribbing as soon as space allows.

A single 2x4x12" wedge should be used as a shim to fill voids between the load and crib beds. This increases stability by transferring the load to additional contact points.

Wedges can also be used to change the angle of thrust in order to get the optimum contact with uneven or sloped surfaces. Wedges can be cut in the field with chain or circular saws, but that can be difficult to do. They can be purchased precut from most lumberyards and should be prestocked in a rescue cache.

### **Cribbing and Crib Beds**

Capacity varies from 200 psi to 1,000 psi depending on wood species. 500 psi is used for emergency shoring. Example:  $500 \times 2.5 \times 3.5 \times 4 = 24,000$ .

#### For a 2-Member x 2-Member Box Crib

4 x 4 box crib capacity = 24,000 lbs (12 tons)

6 x 6 box crib capacity = 60,000 lbs (30 tons)

#### For a 3-Member x 3-Member Cross-tie Crib

4 x 4 cross-tie capacity = 54,000 lbs (27 tons)

6 x 6 cross-tie capacity = 135,000 lbs (67½ tons)

Do not stack cribbing more than two high in the same direction



18" Minimum

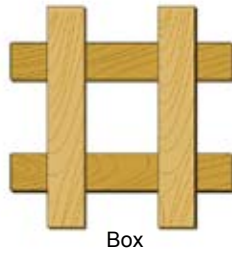
Cribbing



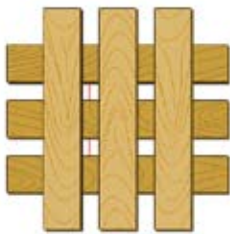
Wedge



Wedge



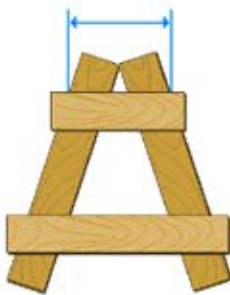
Box



Crosstie



Solid Platform



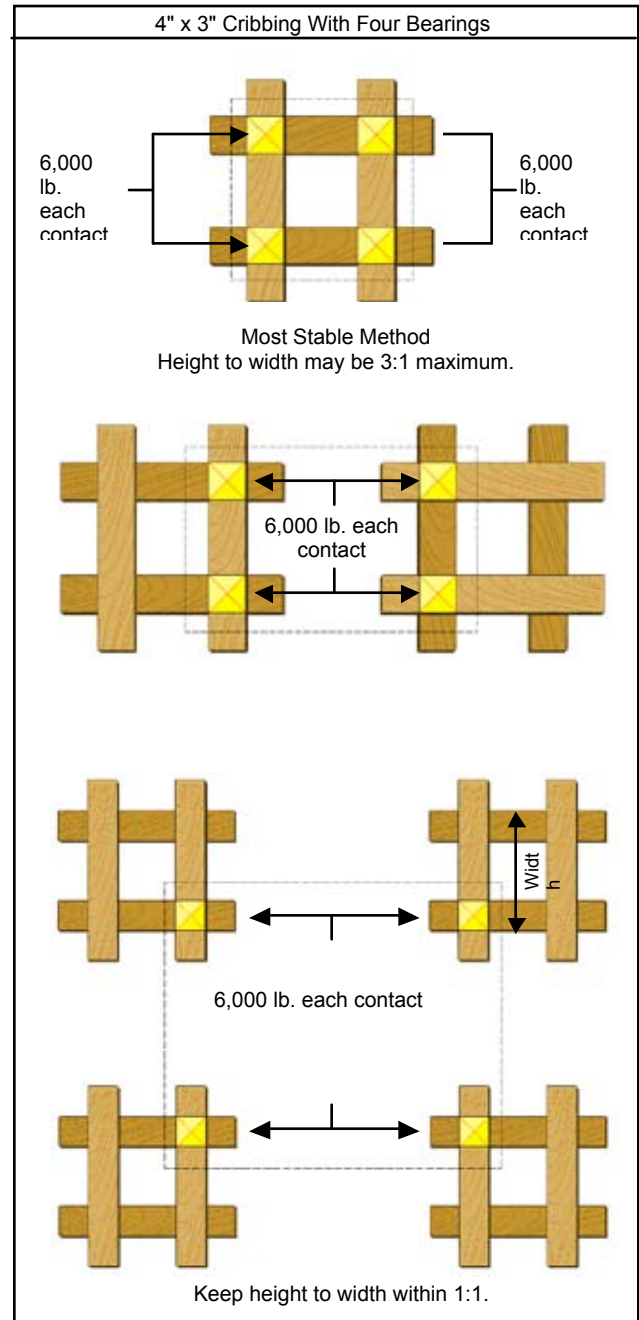
Triangle



Parallelogram

Both are not very stable. Keep height to width within 1:1

Figure 3:7 Cribbing and Crib Beds



## Moving Heavy Objects

In addition to vertically lifting heavy objects, it may be necessary to move objects horizontally in order to access a void or extricate a victim.

An object is easier to move if it can be placed on rollers. This reduces friction and lessens the effort and time required moving the load. Pickets, steel pipe, and round wood posts can be located and improvised out of debris piles, chainlink fence posts, and signposts. If your apparatus permits, carry a small number of pipes for both rollers and pipe screw jacks.

If the ground is soft under the load or if the surface is uneven or broken, it may be necessary to build tracks to support the rollers. In effect, you are building a track system. The load will have to be lifted high enough to slide the tracks and the rollers under the load. Good track systems for rollers are 4x4 timbers or 2x4 or 2x6 stock laid on its wide axis.

It is important to control the movement of a heavy load; failure to do so could cause injury or secondary collapse. Once a load is placed on rollers, the load may move rapidly and with little effort. Therefore, loads should be moved with extreme caution and control. Slow and deliberate movements are the order of the day. A method of braking (having the ability to stop the movement of load) must be in place before lowering the load on rollers. The faster a load is allowed to move, the more difficult it will be to stop. An out-of-control load cannot be slowed or stopped; it will come to rest on its own.

Here are some methods that can be used to help brake or control small loads on a level plane. Remember that all components of any braking system must have the strength to sustain the force of the object in motion.

## Wedges

Wedges can be placed in front of the rollers on both ends where the roller extends beyond the load. This will stop the load as the roller tries to ride up and over the wedge.

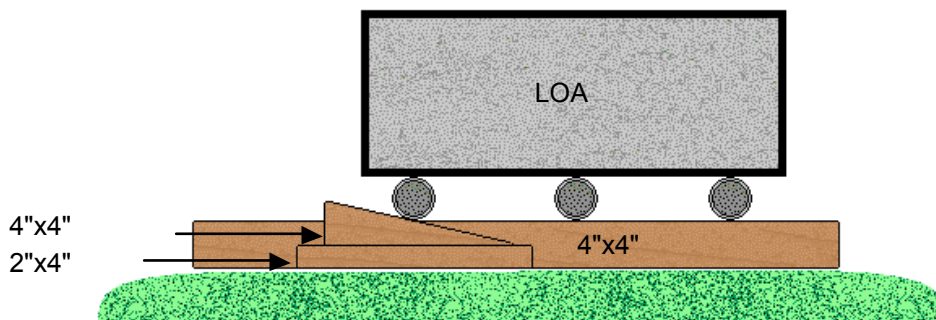


Figure 3:8 Wedges, Cribbing, and Rollers

Wedges can also be placed at the front or sides of the load and are dependent on friction to stop the load. Caution should be used when placing wedges on top of the tracks. This may not create sufficient friction and might shove the wedge in front of the moving load. This method increases risk to rescuers because wedges must be set as the load is moving.



# RESCUE SYSTEMS 1

## Basic Rescue Skills



### Topic 3-1: Introduction to Lifting and Moving Heavy Objects

#### **Class 2 Levers**

Class 2 levers can be used to control or stop a moving load by lifting from the sides. This method allows the rescuers to stay clear of all moving parts due to the length of the pry bar.

If a moving load is permitted to move too fast, none of the above methods will work. To prevent serious rescuer injury, it is critical that rescuers not be positioned in front of or on the downhill side of a moving load. If the situation permits, do **not** attempt to stop a load that is out of control. Stay clear of it. The load will roll off the pipes and ground itself.

#### **Equipment to Move Loads**

A load may be moved with a come-along, mechanical advantage pulley system, or Class 2 levers.

## **Evolution #1**

### **Raise, Stabilize, and Lower a Single Heavy Object**

The students will raise, stabilize, and lower a heavy object. The students will be required to perform size-up and build appropriate crib beds to support and stabilize loads. They will need to use Class 1 levers to complete the exercise and will practice building and adjusting crib beds to the changing angle of an object being raised and lowered.

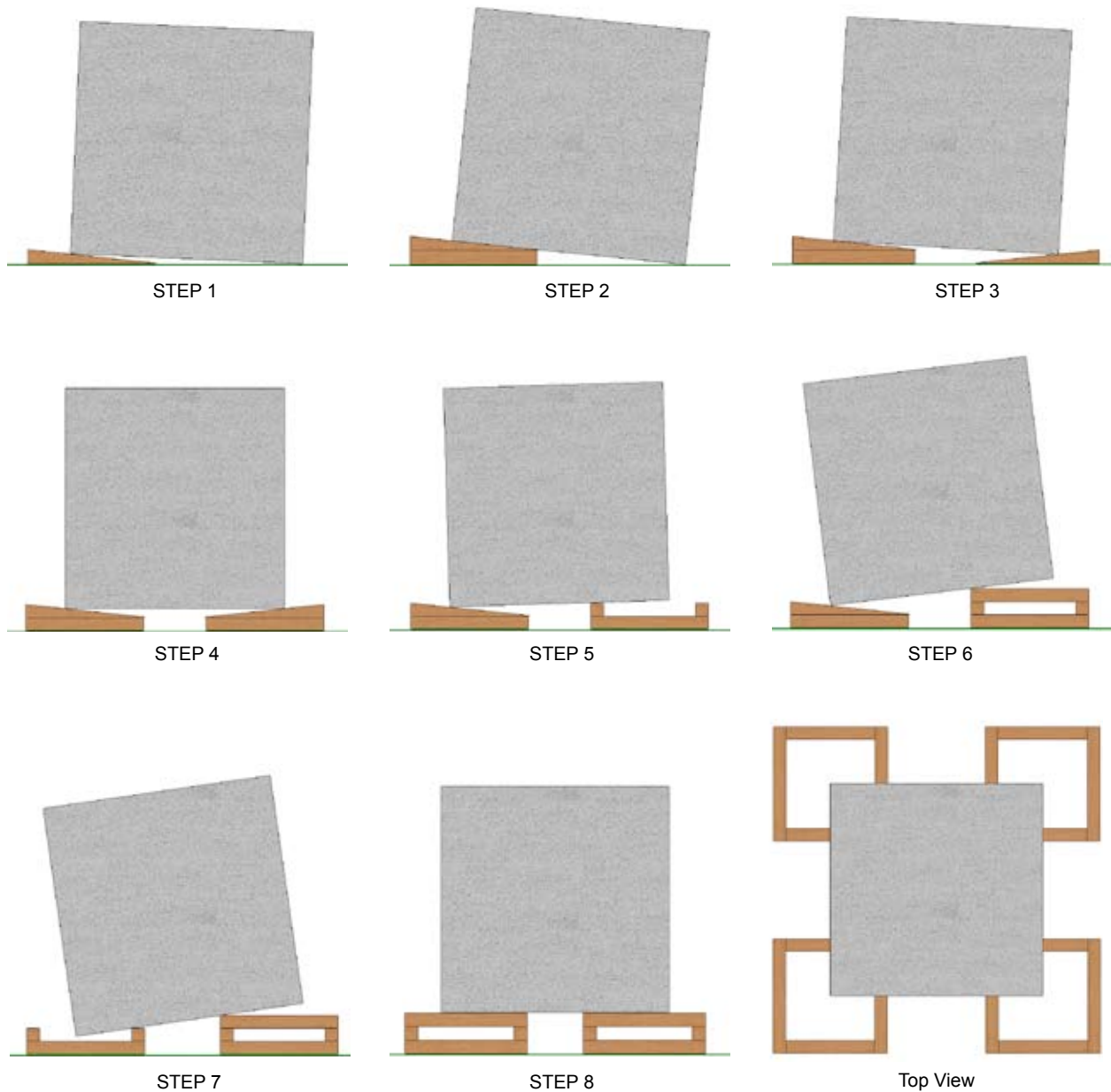


Figure 3:9

## **Evolution #2**

### **Raise, Stabilize, Move, and Lower a Single Heavy Object**

The students will raise, stabilize, move, and lower a single heavy object. They will be required to perform size-up and build appropriate crib beds to support and stabilize loads. They will need to use both Class 1 and Class 2 levers to complete the exercise.

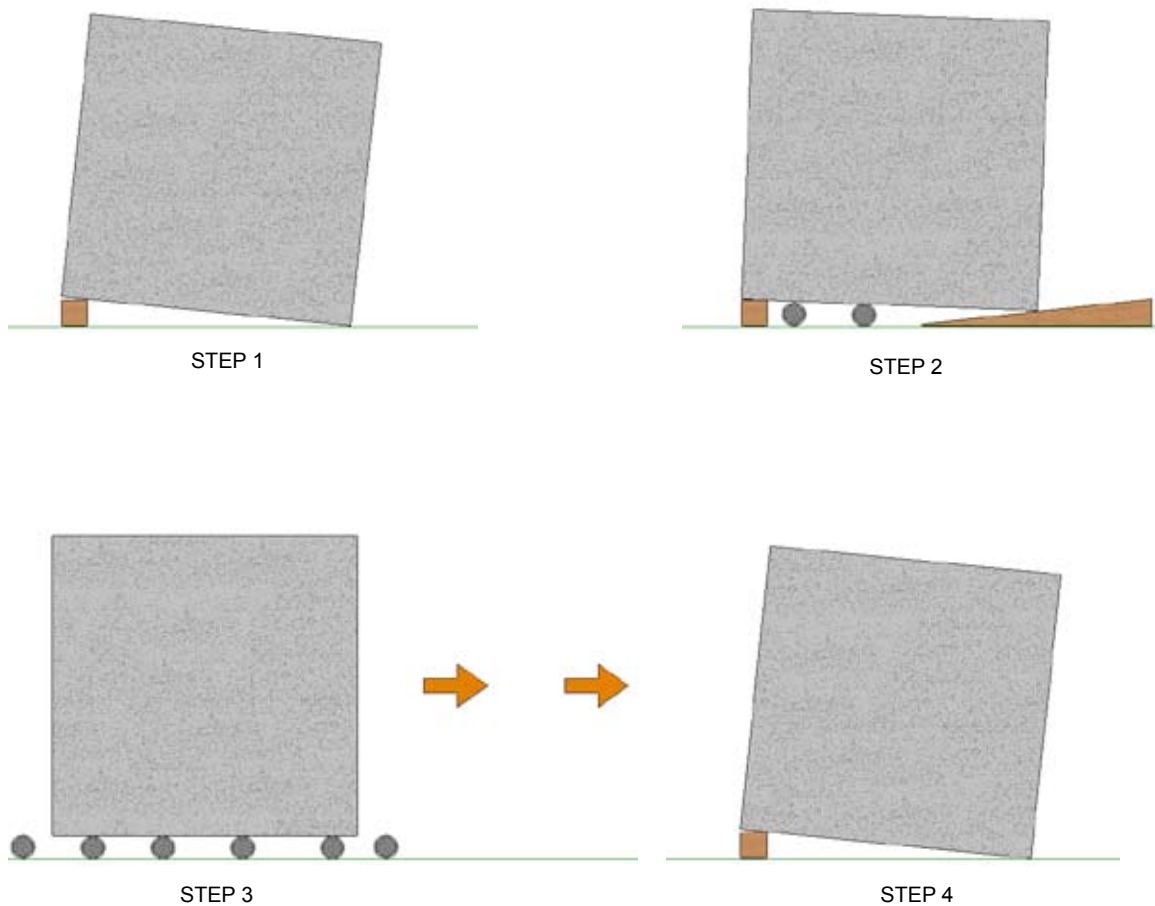


Figure 3:10

## Evolution #3

### **Raise, Stabilize, Rotate, and Lower a Single Heavy Object**

The students will raise, stabilize, rotate, and lower a heavy object. The students will be required to perform size-up and build appropriate crib beds to support, receive, and stabilize loads. They will need to use both Class 1 and Class 2 levers to complete the exercise and will practice building and adjusting crib beds to the changing angle of an object being raised and lowered. The students will also be limited to cribbing the face of the load from end.

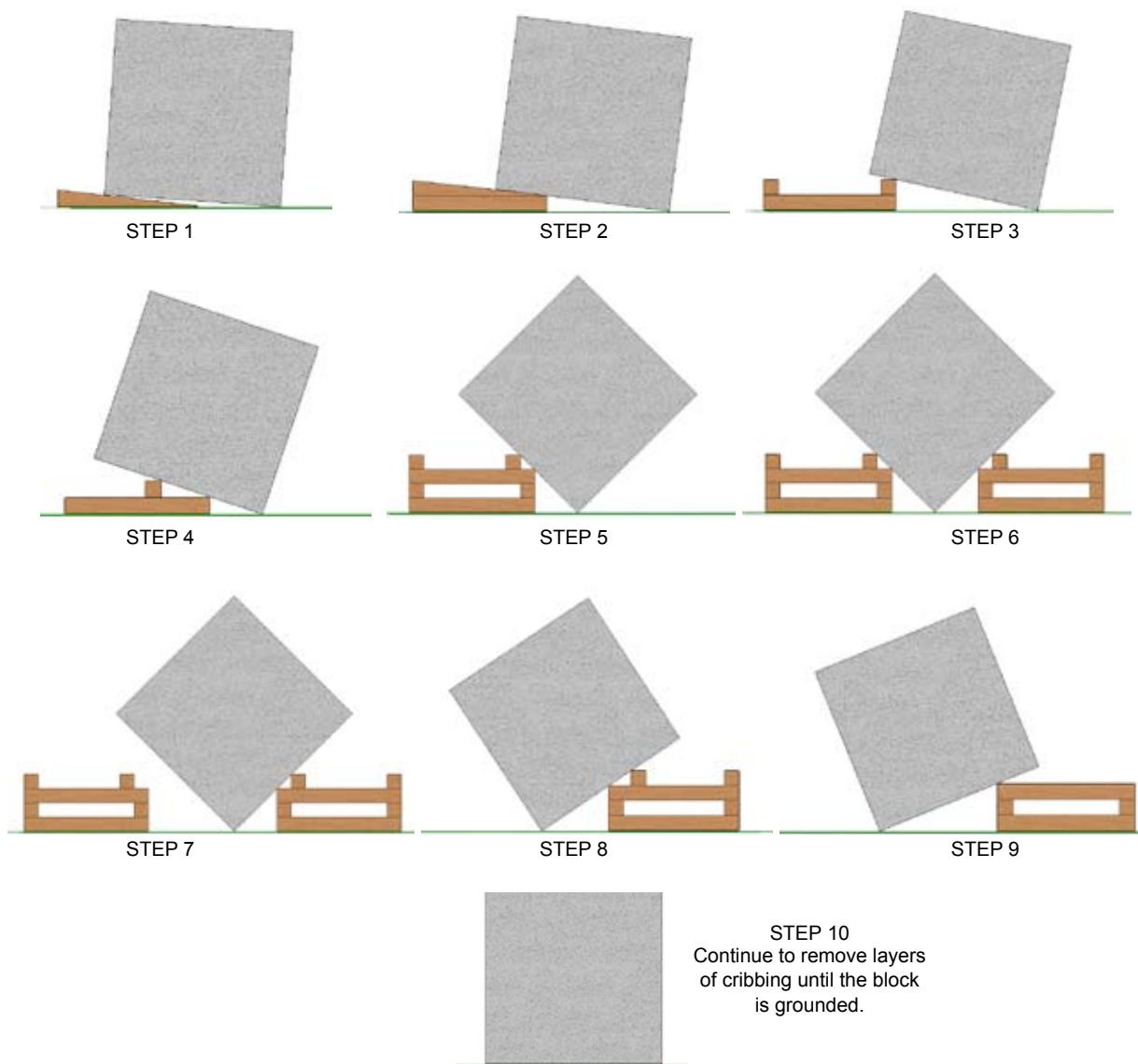


Figure 3:11

## **Evolution #4**

### **Raise, Stabilize, Move, and Lower Multiple Heavy Objects**

The students will raise, stabilize, move, and lower multiple heavy objects. They will be required to perform size-up and build appropriate crib beds to support and stabilize loads. The students will need to use both Class 1 and Class 2 levers to complete the exercise.

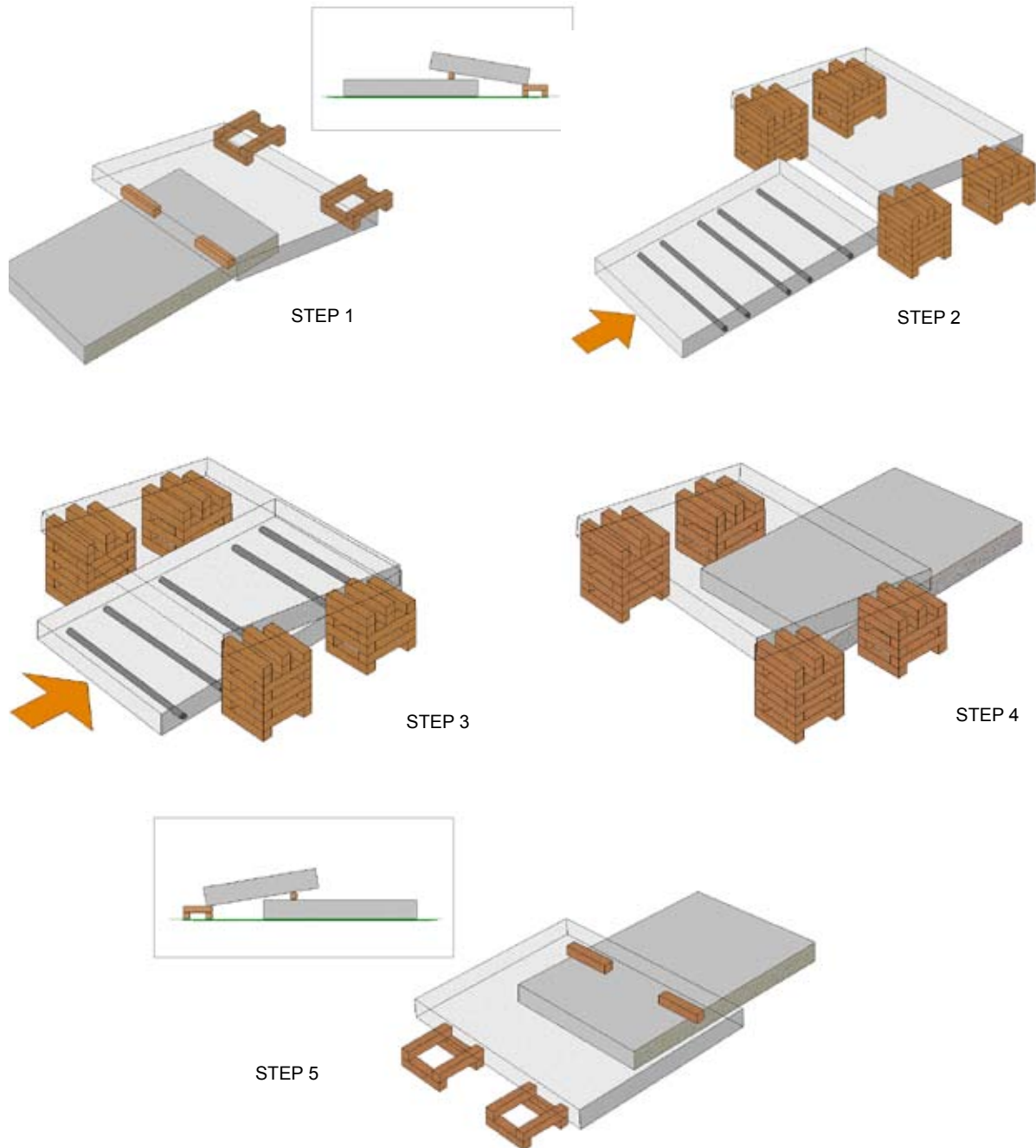


Figure 3:12



## **Evolution #5**

### **Raise, Stabilize, Move, and Lower Multiple Heavy Objects While Safely Managing and Extricating a Victim from Under the Objects**

The students will manage and extricate a victim trapped under multiple heavy objects. They will lift, stabilize, move, and lower multiple heavy objects. The students will be required to perform size-up and build appropriate crib beds to support, raise, and stabilize loads. They will need to use both Class 1 and Class 2 levers to complete the exercise and will practice building and adjusting crib beds to the changing angle of an object being raised and lowered. The students will also be limited to cribbing and lifting from the ends of the void space.

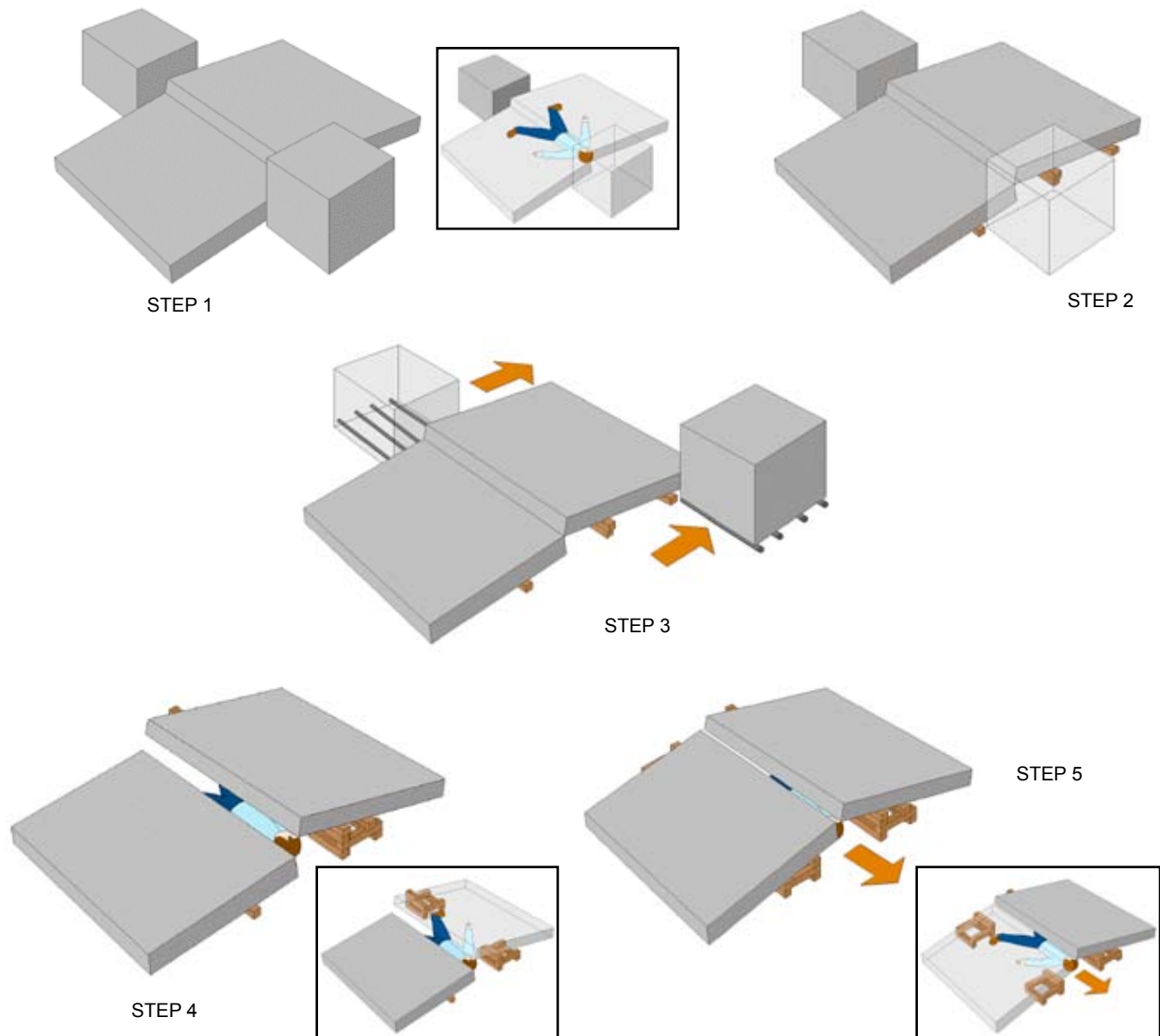


Figure 3:13

## Topic 4-1: Introduction to Breaking and Breaching

**Scope:** This chapter serves as an introduction to Breaking and Breaching.

**Terminal Learning Objective (TLO):** At the end of this chapter, the student will be familiar with a structural collapse incident that requires breaking and breaching operations to gain access, remove debris, or release an entrapped victim. Breaking and breaching operations discussed in this course will focus on light-frame construction materials, such as wood and light-gauge metals, unreinforced masonry such as brick veneer, and reinforced masonry such as a cinder block wall.

**Enabling Learning Objectives (ELO):**

1. Describe tool types, capabilities, and safety considerations when breaking and breaching.
2. Describe light-frame structure design and construction materials.
3. Describe the appropriate personal protective equipment, safety precautions, and medical precautions.
4. Describe breaking and breaching operations including shape and size of breaching openings.
5. Describe breaking and breaching operations in other general construction categories.

Rescue activities at a structural collapse site may require rescuers to force entry through walls, floors, and roof structures in order to gain access to travel corridors, basements, collapse voids, and other areas to search for and rescue trapped victims. Personnel who perform breaking and breaching operations should have an understanding of the structure components and how they are attached and the various tools and techniques required for this operation.

Breaking and breaching in Rescue Systems 1 will focus on light-frame construction materials such as wood and light-gauge metals, unreinforced masonry such as brick veneer, and reinforced masonry such as a cinder block wall. These materials will be discussed in each Building Material Information Sheet.

### **Tools and Equipment**

Breaking and breaching operations will require rescuers to use a variety of hand tools and power tools. Persons performing this work should be familiar with the manufacturer's operating procedures for the power tools used. Personnel should practice and train with these tools in order to become proficient in their use.

Tools and equipment available for breaking and breaching at the US&R Light Operational Level are primarily hand tools that include hammers, handsaws,



Figure 4:1



# RESCUE SYSTEMS 1

## Basic Rescue Skills



### Topic 4-1: Introduction to Breaking and Breaching

hacksaws, pry bars, crowbars, chisels, handheld mauls, sledgehammers, bolt cutters, axes, shovels, hydraulic bottle jacks, and steel pickets. The only power tool is a chainsaw. Other hand tools to consider are wire cutters, tin snips, and utility knives.

Power tools **not** included at the US&R Light Operational Level but considered useful for breaking and breaching through a variety of materials found in lightweight building construction include power rotary saws, electric drills, electric saws, hydraulic spreaders and cutters, and pneumatic chisels. Operators must be familiar with the capabilities of these tools and review the safety guidelines established by the manufacturer prior to use.

A preoperational check of fluid levels, tightness and condition of drive belts and chains, blades, cutting chains, and guide bars should be performed before startup.

## **Light-Frame Structure Design**

### **Foundation**

The foundation of a light-frame structure will be either a flush foundation on a concrete slab or a raised foundation on a cripple wall. The cripple wall can be constructed with lumber or masonry materials and may not be secured to the foundation if built before the late 1960s.

### **Floors**

Floor joists support the floor assembly and floor finish materials. Floor joists are usually located every 12" or 16" on center. Floor finish or covering materials may include wood lath, plywood with 1½"- to 2"-thick concrete, carpet, ceramic tile, and linoleum.

### **Walls**

Studs provide support to the upper floors or roof assembly. Wall studs are usually located every 16" on center. Walls are covered with materials such as stucco, lath and plaster, sheet rock or dry wall, or thin paneling. The perimeter walls are usually load bearing, meaning they help hold up the roof or second floor. Some interior walls are also load bearing and should be checked before cutting any structural members.

### **Roof**

Joists provide support to the perimeter frame and roof covering material. Roof joists are usually located every 16" to 24" on center. Roof covering materials include lightweight items such as wood and asphalt shingles or heavy items such as clay tile or slate.

## **Light-Frame Construction Materials**

Rescuers must be prepared to safely cut through a variety of construction materials, including:

- Wood
  - Dimensional lumber usually including a thickness of 2", 4", and 6" with widths of 4", 6", 8", and 12"
  - Plywood thickness including ½", ¾", and 1⅛" used on floors, shear walls, and roofs
- Light-gauge aluminum for doors, wall studs, and sheathing
- Light-gauge steel for doors and sheathing
- Wood lath and plaster



# RESCUE SYSTEMS 1

## Basic Rescue Skills



### Topic 4-1: Introduction to Breaking and Breaching

- Drywall, sheet rock, or gypsum board
- Stucco on wire stucco lath
- Unreinforced masonry such as brick veneer and chimney
- Reinforced masonry such as cinder block wall and cripple wall
- Lightweight concrete used for sound insulation and moisture protection on floors and usually 1½" to 2" thick

### **Safety Considerations**

Safety considerations should be followed when using any tools. Personal protective equipment such as helmet, eye protection, hearing protection, respiratory protection, safety boots, long-sleeve abrasion-resistant clothing, and gloves should be used consistently. Operators should work within the capabilities of the tool and use the right tool for the job properly. Use and store fuel safely in approved containers. Maintain good ventilation in areas where gas-powered tools are used. Keep aware of your surroundings and continually look for tripping hazards, know the location of other rescuers, maintain firm control of tools at all times, and do not make abrupt turns or movements that could endanger yourself, other rescuers, or victims.

When using electrical power tools, care must be taken to avoid crushing or cutting the power cord. Make sure to keep power cords out of pools of water or other liquids.

Rescuers should have a good understanding of the capabilities and limitations of the available tools. Basic hand tools and power tools work well breaking through light-frame building materials, but they will have limited use on unreinforced masonry buildings and very little success breaching through concrete buildings.

### **Breaking and Breaching Operations**

Rescue teams need to take the time before beginning operations to evaluate the area where any breaking or breaching takes place. They need to determine the collapse potential of the area, what material needs to be cut, whether the material to be cut supports other objects, and whether your actions cause additional collapse.

Consider all possible entrances into the structure or void space before starting the breaching operation. There may be a faster or safer way in through natural openings, such as doors or windows, or openings created by the collapse.

Do not break blindly through walls, floors, or the roof. To do so may cause additional injuries to trapped victims or further collapse. Remove floor, wall, or roof finish materials or coverings before cutting the structural elements. Secure all utilities and mitigate any hazards to prevent injuries. Avoid cutting electrical wires and plumbing, if possible. Cut small inspection holes first to check for anyone or anything in close proximity to where the cut is being made.

If a victim is located in proximity to breach operations, rescuers should perform a clean breach. A clean breach requires the rescuer to cut or break the materials with techniques that prevent the materials from hitting the victim. Because of gravity, most victims may be located on or near the floor or the bottom of collapse piles.

Work carefully so building debris is not dislodged during breaching operations. Install shoring systems to stabilize the site before, during, and after a breaching operation if you determine it to be necessary during your assessment.



# RESCUE SYSTEMS 1

## Basic Rescue Skills



### Topic 4-1: Introduction to Breaking and Breaching

When removing loose debris from the void space or rescue site, remove smaller pieces first before removing large items. Large pieces of debris may be acting as supports for other structural elements.

Breaking and breaching operations in light-frame buildings may require intricate and difficult hand tool usage to cut through normal household items that are blocking rescuer access or entrapping the victim. These items may include box springs, mattresses, bed linen, appliances such as refrigerators and stoves, carpets and other floor coverings, and furniture such as file cabinets and chests of drawers. Touching nylon or latex clothing materials with the running blade of a chainsaw will immediately cause the material to become jammed in the chain and drive gear.

Rescue operations may require the use of hand tools and power tools in very confined areas. Rescuers may be forced to operate these tools in difficult positions such as lying on their back, upside down, or on their side.

It is acceptable to cut through the walls, floors, and roofs of light-frame construction. Interior and exterior structural elements work together to form a stable skeleton that will support holes being cut. Breach finish materials and coverings by initiating openings adjacent to the studs, joists, and rafters to minimize vibration. After structural assessment, breaches may be expanded by removing one adjacent stud, joist, or rafter. Remove one stud and joist after finish materials have been removed. Use extreme caution if required to remove more than two adjacent studs or joists of load-bearing walls and floors. Shoring should be considered and installed before cutting and removal of more than two studs or joists.

Breaking masonry and lightweight concrete is best accomplished by enlarging the cracks and fractures caused by the collapse. If no cracks are present, the rescuer should attack the cement joints on the brick veneer and the cells of the cinder block. Remove loose masonry and concrete from around reinforcing bars (rebar) and cut or bend it out of the way. Enlarge breaching holes by breaking the masonry and concrete away from the edges of the initial hole.

Breaking and breaching operations will be time consuming, labor intensive, and very frustrating. Always look for the lightest material to breach, checking all six sides of the structure. The objective is to efficiently and safely create access openings.

### **Shape and Size of Breached Openings**

The shape and size of a breached opening will be dependent on the intended use of the hole. The initial hole should be large enough for a rescuer to gain access for search operations and victim care. Minimum shapes and sizes to allow access of a rescuer wearing proper personal protective equipment have been determined.

### **Rectangle**

The initial rectangle opening should cut the finished product between the structural members. The structural members can be located in a framed structure by locating material joints or nail patterns or by sounding for structural members. The depth of cuts should be limited to the thickness of finished materials to prevent cutting wiring and plumbing and to prevent injury to potential victims.

In a framed structure, the initial opening created will be approximately 12" wide x 24" high or 22" wide x 24" high based on framing centers. After accessing the adjacent structural members for stability, the initial opening can be expanded by removing one stud, joist, or rafter to provide better access for rescuers and a



# RESCUE SYSTEMS 1

## Basic Rescue Skills



### Topic 4-1: Introduction to Breaking and Breaching

victim secured to a backboard or wire basket stretcher. It requires four cuts and is not recommended for masonry walls because it will reduce the strength at the top of the opening.

#### **Circular**

This shape is most often used to breach masonry products and is desired for masonry walls because it will not reduce the strength at the top of the opening. The circular shape is created by breaching an initial hole in the material and then enlarging the opening by hitting the outer edge with a sledgehammer or hand maul. If the material has a weakness, such as a crack, joint, or space between reinforcing, use this weakness to place the masonry product into tension or shear to speed up the breach operation.

The initial opening should be oval in shape, approximately 24" wide x 14" high. This shape requires the least amount of time to create an opening large enough for rescuer access. The hole can be expanded to meet operational needs.

#### **Other General Construction Categories**

During a rescue operation or large incident with limited resources, it may be necessary for rescuers to break and breach construction materials other than light-frame construction. Some general guidelines to follow are:

#### **Heavy Wall Construction**

##### ***Unreinforced Masonry***

Rescuers should avoid cutting through walls. Breaching through unreinforced masonry walls may cause additional collapse or building instability. Instead, rescuers should look for existing natural or created horizontal openings. Rescuers can safely force entry through floors and roof sections.

##### ***Reinforced Masonry and Concrete Tilt-Up***

It is possible to cut through these walls, although they may be 5" to 8" thick, which makes basic hand tools and power tools almost useless. Reinforcing bars within the concrete will add additional difficulty for rescuers trying to break through. Rescuers should use existing openings in these structures to gain entry whenever possible.

#### **Heavy Floor Construction**

It is possible to cut through these walls and floors, although they may be 5" to 8" thick, which makes basic hand tools and power tools almost useless. Reinforcing bars within the concrete will add additional difficulty for rescuers trying to break through. Rescuers should use existing openings in these structures to gain entry whenever possible.

#### **Precast Concrete Construction**

It is possible to cut through wall panels and floors only after assessing the stability of the panel and its connection to the main structure. The concrete floor panels may be 5" to 8" thick with metal reinforcing bars or post- and pretensioned cables. Cutting these cables can be extremely dangerous and can cause further collapse or injury to the rescuers if certain precautions are not taken. Again, basic hand tools and power tools are ineffective in attempting to force through this construction. Horizontal entry should be gained through existing openings.

## **Building Material Information Sheet #1: Stucco**

### **Definition**

- A cement, sand, and lime mixture used for siding or surfacing interior or exterior walls
- Sublayers include wood sheeting, building paper, and reinforcing wire
- Normally applied in a two- or three-coat process
- A rough coating for exterior walls

### **Common applications**

- Exterior walls

### **Common nomenclature**

- Cementitious-based stucco coating

### **Material specific hazards**

- Inhalation hazard: cement and insulation dust
- Penetration/laceration hazard: reinforcing wire

### **Tool selection guidelines**

- Axe, pick head or flat head
- Cold chisel, 1" x 7/8"
- Duct tape
- Handsaw, 26" crosscut
- Haul bucket
- Lumber crayon
- Pinch point pry bar
- Side cutters
- Sledgehammers
  - One 2- to 4-pound
  - One 8- to 10-pound
- Steel picket, 1" x 4'
- Utility knife
- Wrecking bar, 30" claw

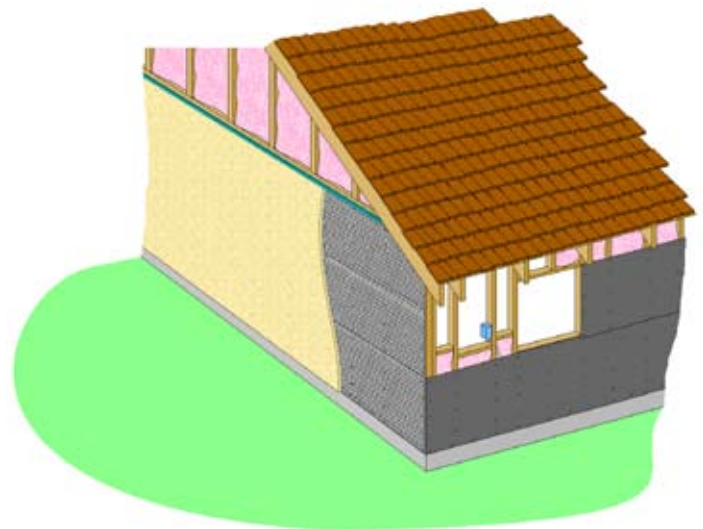


Figure 4:2

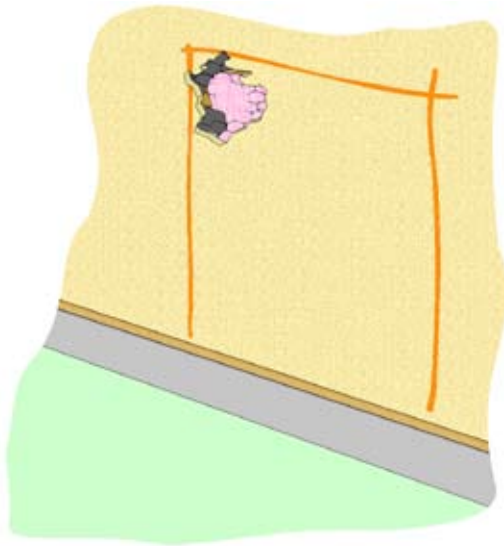


Figure 4:3

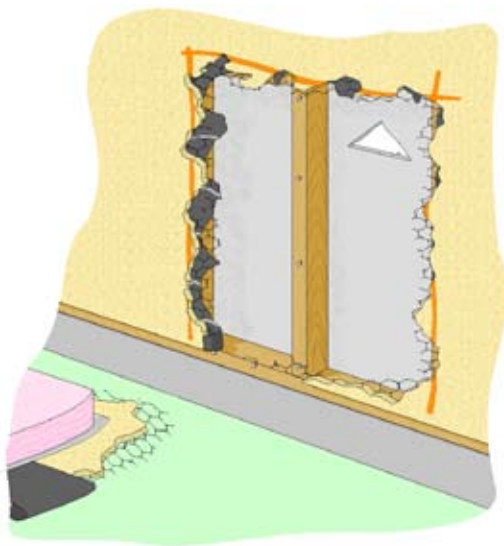


Figure 4:4

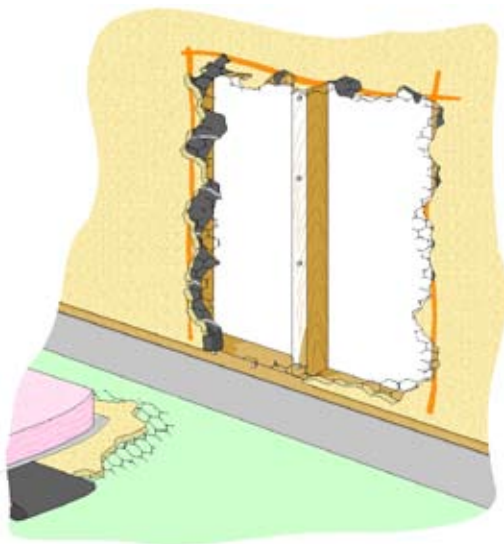


Figure 4:5

## Breaking and breaching techniques

- Identify a point of entry by sounding.
- Determine the entry area's function prior to breach.
- Determine the size and shape of the opening; mark the area using a lumber crayon.
- Breach exterior surface with a striking tool; cut an inspection hole first.
- Cut wire or K-lath and remove the stucco.
- Remove the moisture barrier (cut or tear).
- Breach the plywood layer (if present).
- Remove any insulation and wiring as needed, using appropriate tools.
- Cut an inspection hole in the interior wall covering.
- Evaluate the environment for hazards.
- Visualize nearby victims and cut or breach away from them.
- Breach and remove the interior wall covering.
- Remove the wall stud as needed, but no more than one stud.
- Remove general debris.



## **Building Material Information Sheet #2: Lightweight Steel**

### **Definition**

- A steel or aluminum material used for siding exterior walls

### **Common applications**

- Exterior walls

### **Common nomenclature**

- Aluminum or steel siding

### **Material specific hazards**

- Inhalation hazard: insulation dust
- Penetration/laceration hazard: sharp edges

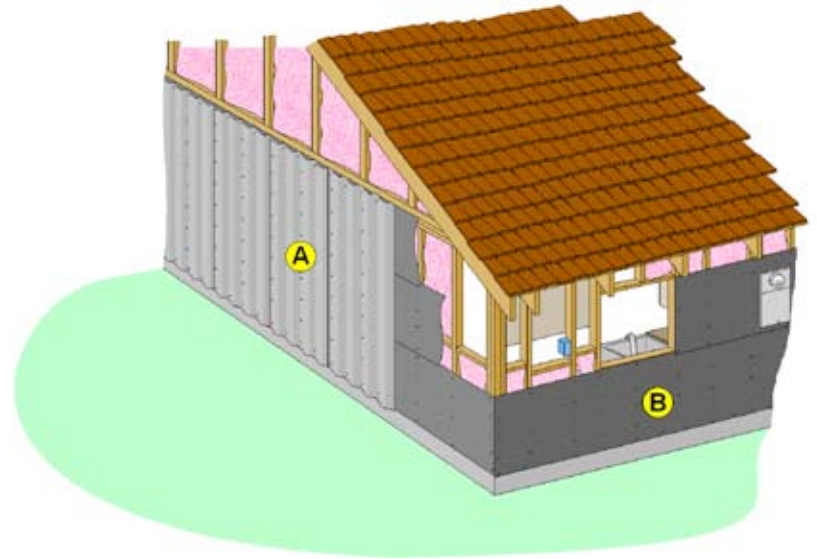


Figure 4:6

### **Tool selection guidelines**

- Axe, pick head or flat head
- Cold chisel, 1" x 7/8"
- Duct tape
- Handsaw, 26" crosscut
- Haul bucket
- Lumber crayon
- Pinch point pry bar
- Side cutters
- Sledgehammers
  - One 2- to 4-pound
  - One 8- to 10-pound
- Steel picket, 1" x 4'
- Utility knife
- Wrecking bar, 30" claw

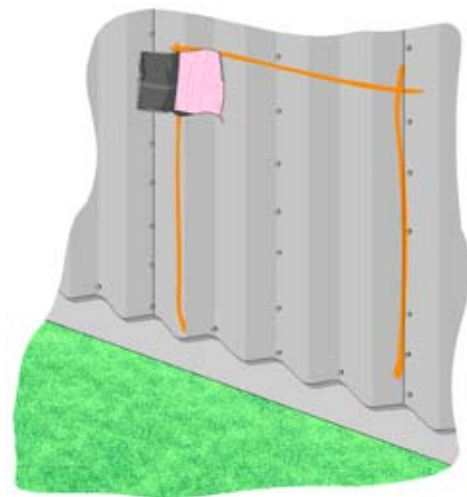


Figure 4:7

## Breaking and breaching techniques

- Identify a point of entry by sounding.
- Determine the entry area's function prior to breach.
- Determine the size and shape of the opening; mark the area using a lumber crayon.
- Breach exterior surface with a striking tool; cut an inspection hole first.
- Remove the moisture barrier (cut or tear).
- Breach the plywood layer (if present).
- Remove any insulation and wiring as needed, using appropriate tools.
- Cut an inspection hole in the interior wall covering.
- Evaluate the environment for hazards.
- Visualize nearby victims and cut or breach away from them.
- Breach and remove the interior wall covering.
- Remove the wall stud as needed, but no more than one stud.
- Remove general debris.

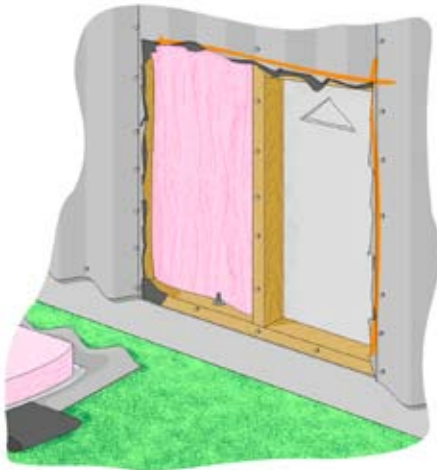


Figure 4:8

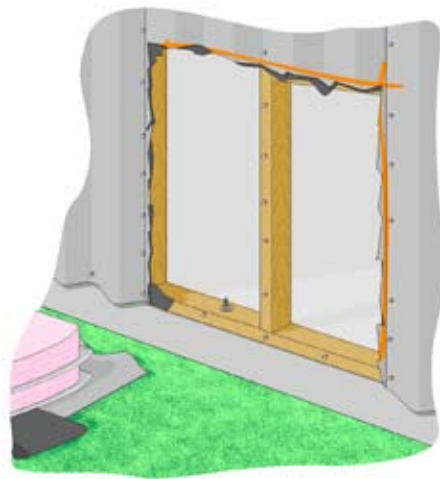


Figure 4:9

## **Building Material Information Sheet #3: Masonry**

### **Definition**

- A cinder block material used for exterior walls

### **Common applications**

- Exterior walls

### **Common nomenclature**

- Cinder block wall

### **Material specific hazards**

- Inhalation hazard: insulation dust
- Penetration/laceration hazard: sharp edges

### **Tool selection guidelines**

- Axe, pick head or flat head
- Cold chisel, 1" x 7/8"
- Duct tape
- Handsaw, 26" crosscut
- Haul bucket
- Lumber crayon
- Pinch point pry bar
- Side cutters
- Sledgehammers
  - One 2- to 4-pound
  - One 8- to 10-pound
- Steel picket, 1" x 4'
- Utility knife
- Wrecking bar, 30" claw

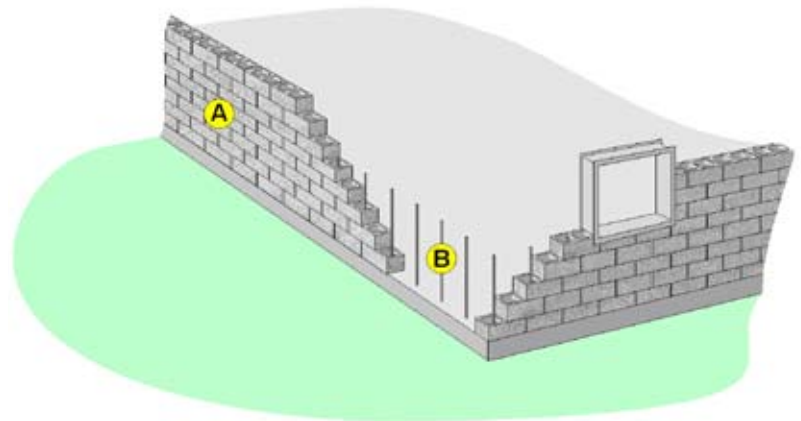


Figure 4:10

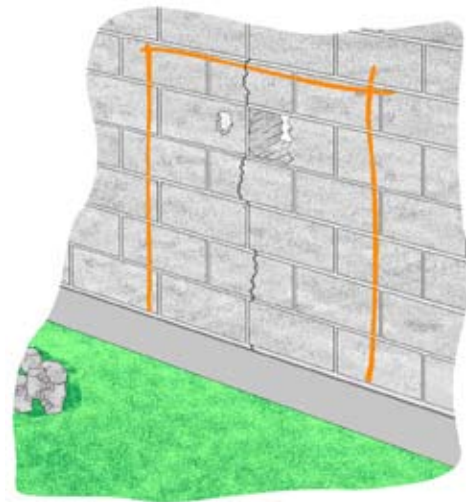


Figure 4:11

### **Breaking and breaching techniques**

- Identify a point of entry by sounding.
- Determine the entry area's function prior to breach.
- Determine the size and shape of the opening; mark the area using a lumber crayon.
- Breach exterior surface with a striking tool; cut an inspection hole first.
- Remove the moisture barrier (cut or tear).

- Breach the plywood layer (if present).
- Remove any insulation and wiring as needed, using appropriate tools.
- Cut an inspection hole in the interior wall covering.
- Evaluate the environment for hazards.
- Visualize nearby victims and cut or breach away from them.
- Breach and remove the interior wall covering.
- Remove the wall stud as needed, but no more than one stud.
- Remove general debris.

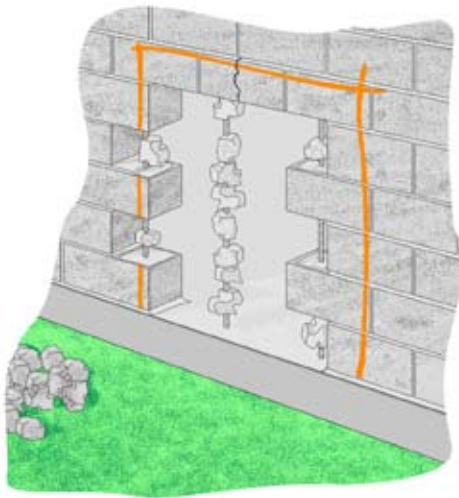


Figure 4:12

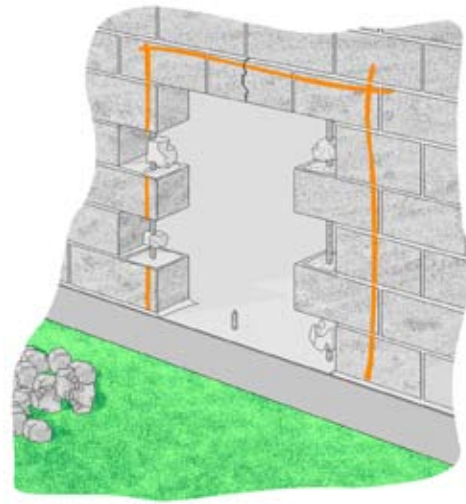


Figure 4:13

## **Building Material Information Sheet #4: Laminate Veneer**

### **Definition**

- A laminated material used for siding exterior walls

### **Common applications**

- Exterior walls

### **Common nomenclature**

- Half brick/wood siding

### **Material specific hazards**

- Inhalation hazard: insulation dust
- Penetration/laceration hazard: sharp edges

### **Tool selection guidelines**

- Axe, pick head or flat head
- Cold chisel, 1" x 7/8"
- Duct tape
- Handsaw, 26" crosscut
- Haul bucket
- Lumber crayon
- Pinch point pry bar
- Side cutters
- Sledgehammers
  - One 2- to 4-pound
  - One 8- to 10-pound
- Steel picket, 1" x 4'
- Utility knife
- Wrecking bar, 30" claw

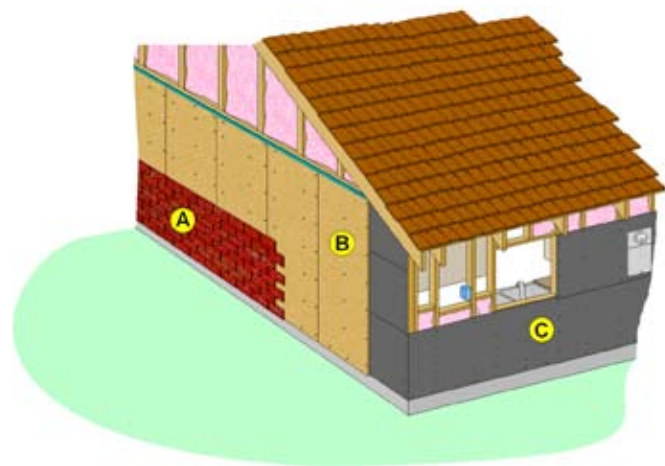


Figure 4:14

## Breaking and breaching techniques

- Identify a point of entry by sounding.
- Determine the entry area's function prior to breach.
- Determine the size and shape of the opening; mark the area using a lumber crayon.
- Breach exterior surface with a striking tool; cut an inspection hole first.
- Remove the moisture barrier (cut or tear).
- Breach the plywood layer (if present).
- Remove any insulation and wiring as needed, using appropriate tools.
- Cut an inspection hole in the interior wall covering.
- Evaluate the environment for hazards.
- Visualize nearby victims and cut or breach away from them.
- Breach and remove the interior wall covering.
- Remove the wall stud as needed, but no more than one stud.
- Remove general debris.

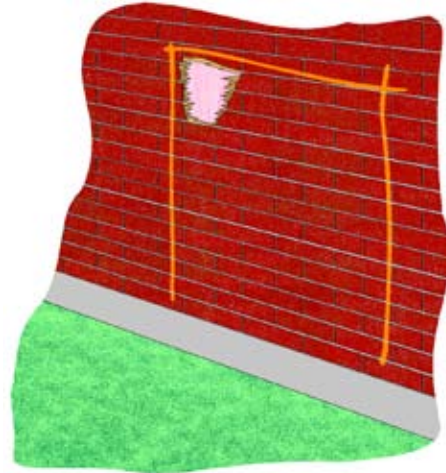


Figure 4:15



Figure 4:16



Figure 4:17



---

# RESCUE SYSTEMS 1

## Basic Rescue Skills

---



### Topic 4-1: Introduction to Breaking and Breaching

---



# RESCUE SYSTEMS 1

## Basic Rescue Skills

### Topic 5-1: Ladder Rescue Systems



## Topic 5-1: Ladder Rescue Systems

**Scope:** This chapter serves as an introduction to Ladder Rescue Systems.

**Terminal Learning Objective (TLO):** At the end of this chapter, the student will be familiar with the skills and techniques to move patients from a low place to a high place, a high place to a low place, or across uneven terrain. Rescuers will use fire service ladders and rope rescue equipment to build systems to accomplish this transport quickly and safely.

**Enabling Learning Objectives (ELO):**

1. Describe the components and operational functions of the seven ladder systems.
  - Moving ladder slide
  - Ladder slide
  - Exterior leaning ladder
  - Interior leaning ladder
  - Cantilever ladder
  - Ladder gin
  - Ladder “A” frame
2. Describe the components and operational functions of the mechanical advantage system used in a ladder rescue system.

During most disasters, there will be many victims and not enough equipment or rescuers to go around. Rescue from elevated structures or below-grade areas of structures or hillsides will have to be done quickly and efficiently while maintaining a good safety margin for both the rescuers and the victims.

### Ground Ladders

Fire service ground ladders can be used in a number of ways to move victims quickly and safely, with a minimum of technical knowledge or additional equipment.

All ladders used for ladder rescue systems must satisfy NFPA standards for fire service ladders (Standards 1931 and 1932) in design, use, maintenance, and annual testing. A 12' to 16' straight ladder works best. Extension ladders up to 35' can also be used when building ground ladder systems. It is best when the extension ladder height is kept to an absolute minimum.

### **Seven Ladder Systems**

1. Moving ladder slide
2. Ladder slide
3. Exterior leaning ladder
4. Interior leaning ladder
5. Cantilever ladder
6. Ladder gin
7. Ladder “A” frame

### **Key Points**

- All of the ladder rescue systems shown can support one-person loads.
- Rescue Systems 1 will use only one-person loads on all ladder rescue systems.
- The ladder “A” frame is capable of a two-person load if rigged properly and used safely.



## Ladder Rescue Systems Components

### Mechanical Advantage System

All ladder rescue systems, except the moving ladder slide, require the use of a rope system. This chapter introduces you to the 2:1 mechanical advantage system, also known as the “ladder rig.”

### *Key Points*

- ❑ The ladder rig is intended for one-person loads.
- ❑ It is used to raise either victims or rescuers.
- ❑ The ladder rig is simply the 3:1 pig, learned in the Low Angle Rope Rescue Operational class, inverted with the load and anchor end attachments switched.

### *Construction*

1. Tie a Figure Eight on a Bight with a 4" loop in the end of the line.
2. Place rope on the ground, forming two bights as shown below.
3. Place bight “B” into pulley and connect a carabiner to this pulley.
4. Connect load to this carabiner.
5. Place bight “A” into pulley and connect a carabiner to this pulley.
6. Secure Figure Eight on a Bight into this carabiner on top of the pulley.
7. Connect the carabiner to:
  - The midpoint of the guy line for “A” frames and gins
  - The ladder sling for exterior, interior, and cantilever ladders
  - The head of the rescue litter for the ladder slide

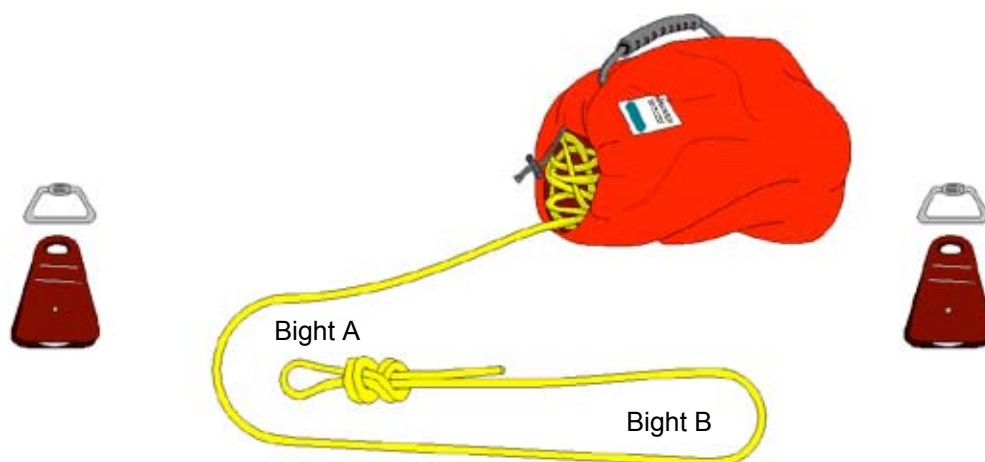


Figure 5.1 : Ladder Rig Components

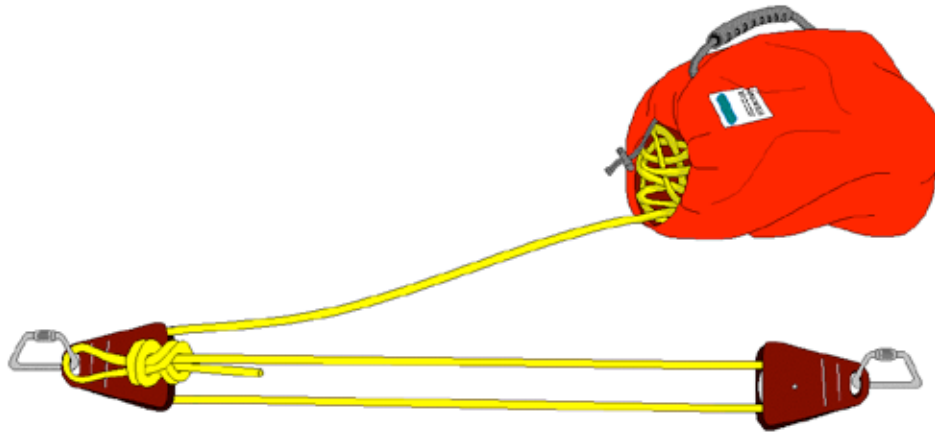


Figure 5:2 Assembled 2:1 Ladder Rig

## Belay/Safety Line

### *Low Method*

The belay/safety line should go from the tandem prusik belay, along the ground, and into the hole/opening. If the ladder system fails, the belay/safety line will not have to fall that distance, thereby preventing any additional shock forces on the belay. This reduces the fall factor if the belay/safety line is activated.

The anchor point for the belay/safety line should be located at least 20' from the opening. Situations may arise where a high-method directional change in belay will need to be made, which will require careful planning and rigging considerations.

### *High Method*

Another method used to incorporate a belay/safety line into the system is to use the base of the ladder as an anchor point. This is done by placing a simple ladder sling around the base of the ladder and bringing the webbing up between rungs one and two. Attach the load-releasing hitch and tandem prusiks to the webbing. Attach safety rope into system and place the working end of the rope over the top rung or through a carabiner on an independent ladder sling to change the rope's direction at the top of the ladder.

#### BELAY/SAFETY LINE - LOW METHOD

**PROS**  
Placement  
Independent  
Fall Factor

**CONS**  
Leverage - Difficult to Raise Line When Loaded  
Edge Protection  
Second Anchor Needed

#### BELAY/SAFETY LINE - HIGH METHOD

**PROS**  
Leverage - High Point  
Limited Edge Protection  
No Second Anchor Point  
Self-Contained

**CONS**  
Fall Factor  
System Dependent  
Placement



# RESCUE SYSTEMS 1

## Basic Rescue Skills

### Topic 5-1: Ladder Rescue Systems



## Anchor Points

A variety of anchors are used with ladder rescue systems. In structural environments, the ladder itself may be the anchor or a structural component such as a beam, spanned doorway, or window may be used.

In ladder rescue systems used outside, such as a ladder gin or ladder “A” frame, artificial anchors, such as pickets or vehicles, may be used. Natural anchors, such as trees and rocks, may also be used if conveniently located.

## Ladder Slings

Fire service ladders can provide high anchor points and directional changes for rope rescue systems. Ladder slings provide a secure and convenient method of attaching rope rescue systems to ladders.

A ladder sling is made from 1" tubular webbing in either 12-foot or 15-foot lengths. The webbing is wrapped around the ladder and over a rung to create a hanging loop of doubled webbing. There are two ways to tie a ladder sling. One is tied around the ladder, a simple ladder sling, and the other is “pre-tied” and then wrapped around the ladder.

To tie a **simple ladder sling**, a 1" length of webbing is wrapped around both beams of the ladder and the ends are tied together with an overhand bend. The loop can now be positioned by either climbing the ladder, such as in an exterior leaning ladder system, or by sliding it into position, such as with an interior or cantilever ladder system. After reaching the position of use, pull both sides of the webbing through the ladder, between the beams, and the rung where the sling is to rest. Attach a carabiner to the sling, making sure to capture both sides of the loops.

A **pre-tied ladder sling** uses a 15-foot length of webbing that is tied into a loop with an overhand bend. The loop and two carabiners are then taken to the position of use on the ladder. The pre-tied ladder sling is attached to the ladder by wrapping both bights around the ladder, capturing both beams, and above the rung where the sling will rest. Connect the bights with a carabiner and pull both sides of the webbing through the ladder, toward the side of use. Attach a carabiner to the sling, making sure to capture both sides of the loops.

After attaching either sling, you must ensure that the Overhand Bend knot of the simple ladder sling or the carabiner attaching the bights of the pre-tied sling are positioned so as not to bind with the ladder beams or interfere with the carabiner that attached the rope system to the sling. Also, ensure that the critical angle of the sling is 90° or less.

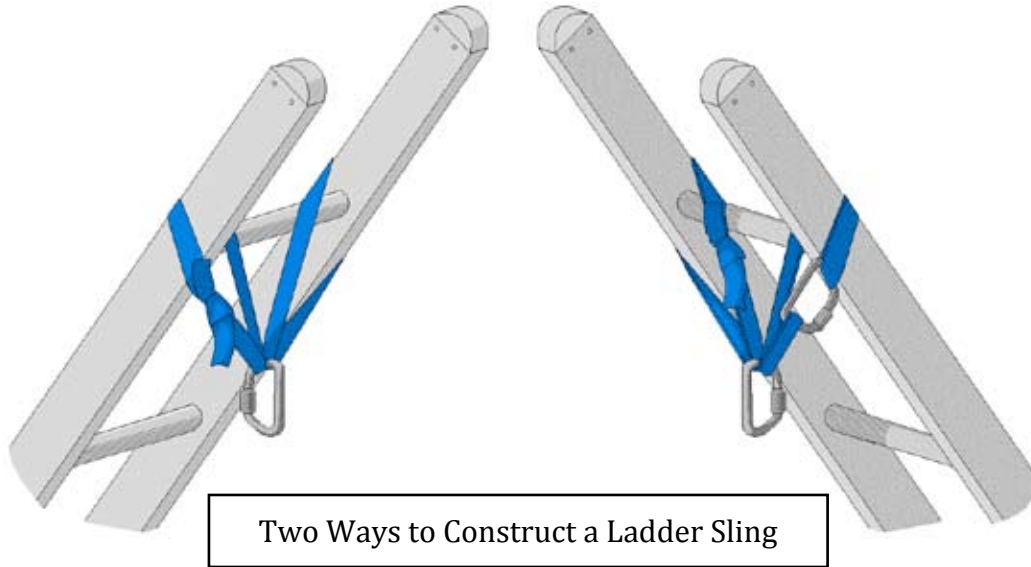


Figure 5:3 Simple Ladder Sling

Figure 5:4 Pre-tied Ladder Sling

## Lashing

Lashing is used to bind two or more objects together by wrapping and frapping turns using ½"-diameter rope or 1" tubular webbing. Lashing is started and finished with one round turn and two Half Hitches or using a Clove Hitch. There are two methods of lashing, round lashing and square lashing. Round lashing consists of six or more wraps and two or more fraps. Square lashing consists of four or more wraps and the same number of fraps.

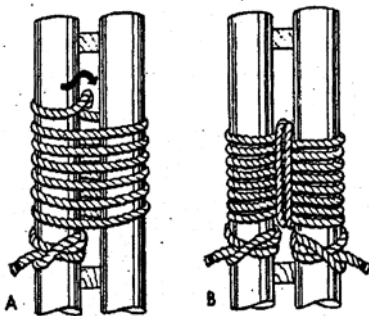


Figure 5:5 Round Lashing

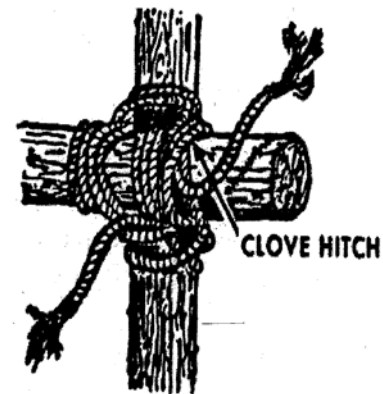


Figure 5:6 Square Lashing

When lashing ladders together or baskets to ladder rungs, use only the wrapping portion of the round lash. In these applications, surface area contact is desired.

## Seven Methods of Using Fire Service Ladders

### 1. Moving Ladder Slide

The litter may be lashed at the butt end of the ladder when negotiating grade changes or obstacles. When operating on level ground, the litter is lashed at the center of the ladder.

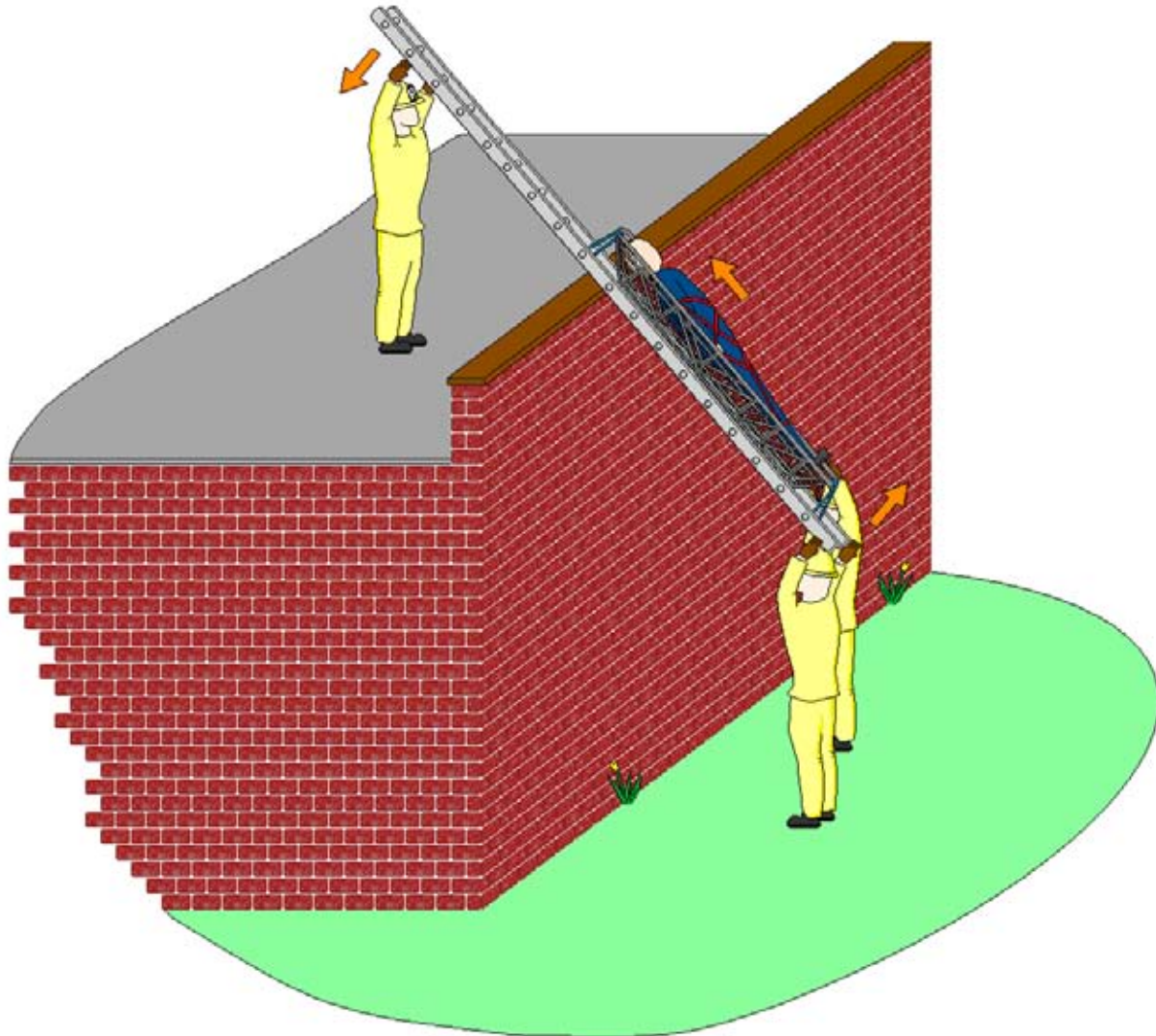


Figure 5:7

## 2. Ladder Slide

A ladder slide is a very useful tool and can be used with any length of ladder. The ladder serves as a guide and supports a large portion of the weight of the victim being lowered. It eliminates the need for elaborate rope rescue systems and turns a high-angle rescue into a low-angle rescue.

A victim in a rescue litter can be raised using a simple 2:1 pulley system or can be lowered using a friction system. If a victim needs to be lowered from an upper floor of a building and a ladder is available that will reach to the window, a ladder slide is the quickest and easiest method of evacuation.

The belay/safety line on the ladder slide should be attached to a separate anchor point, if possible, and managed with a tandem prusik belay and load-releasing hitch.

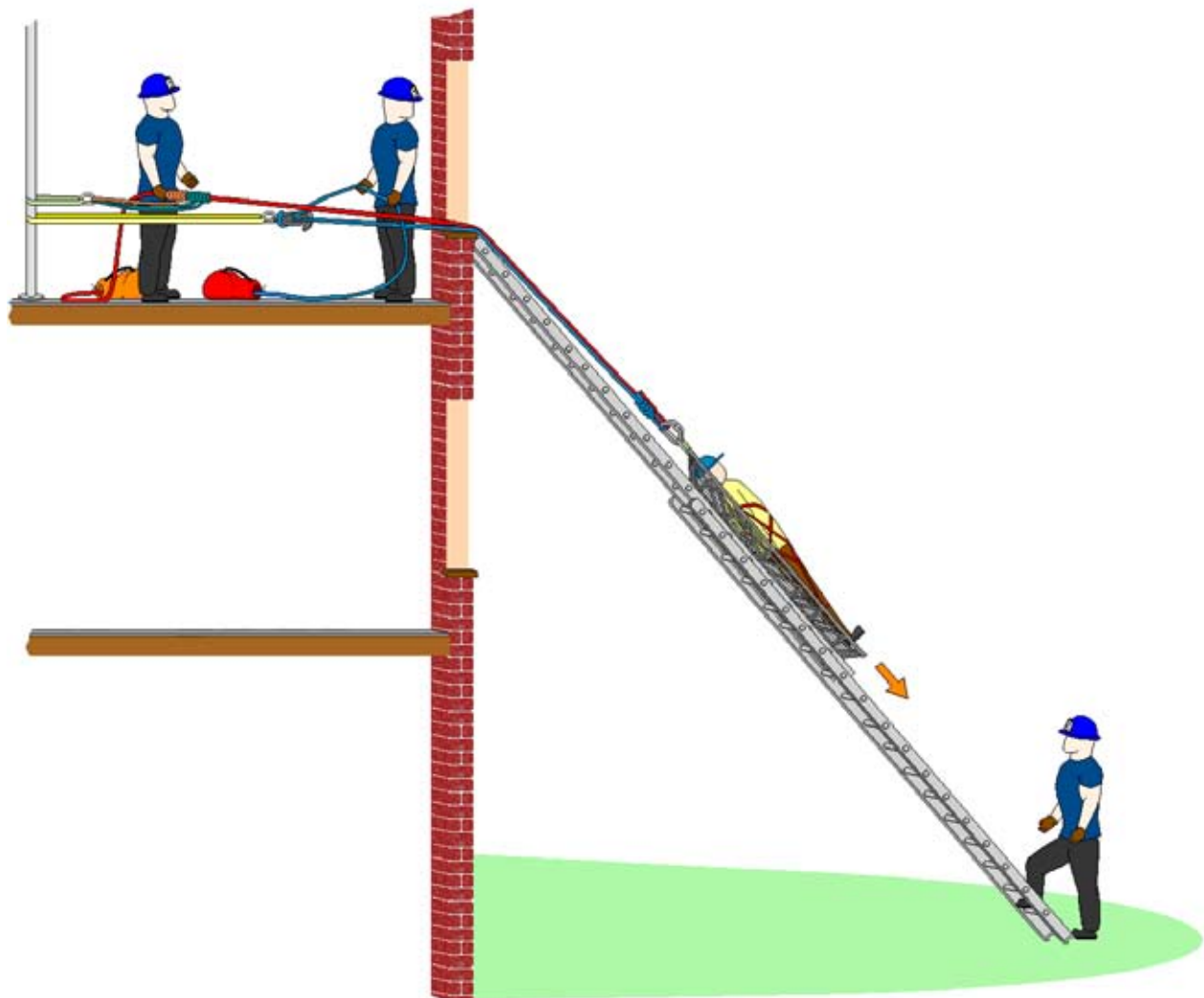


Figure 5:8 Ladder Slide: Lowering

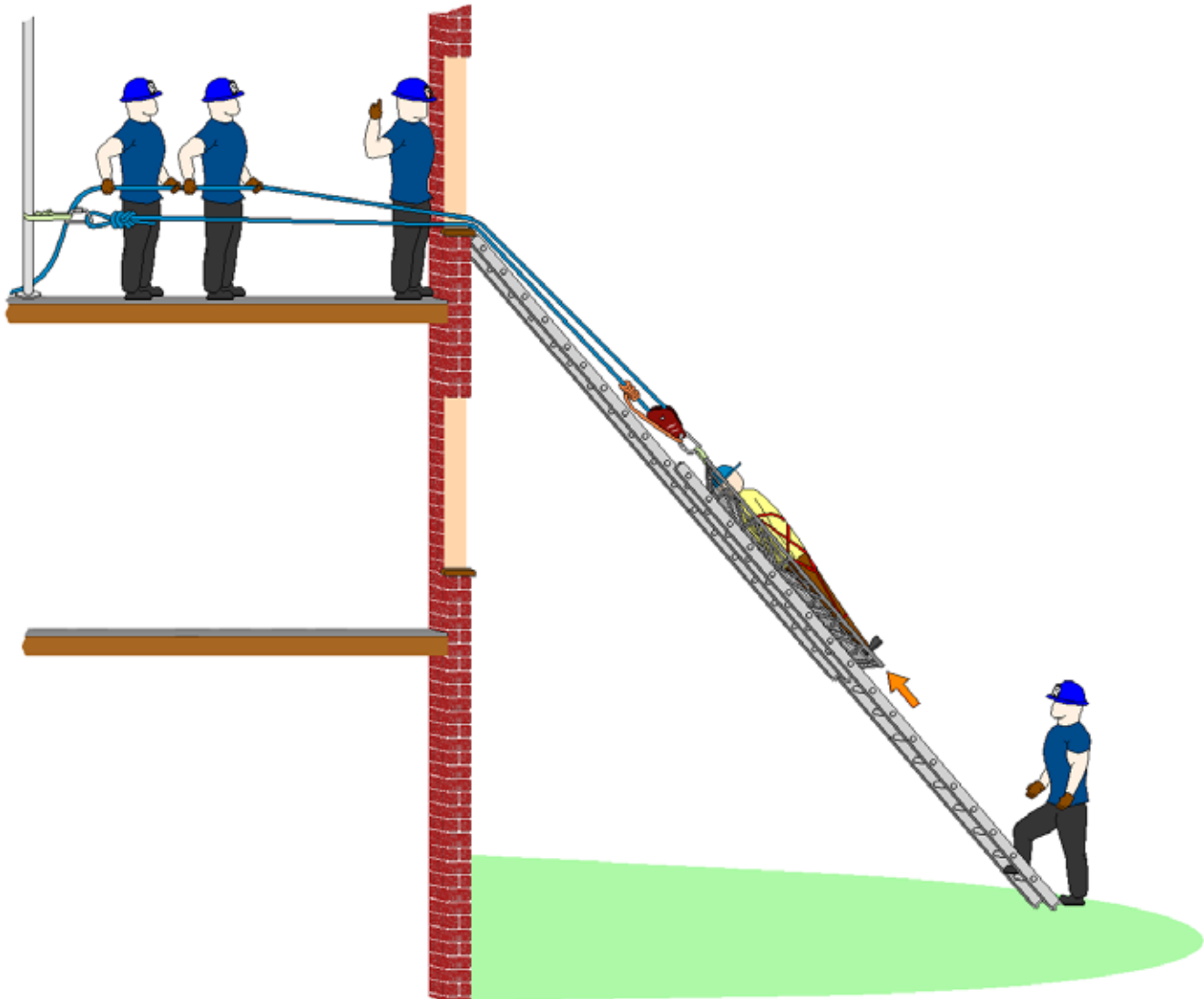


Figure 5:9 Ladder Slide: Raising with MA

Ladder slides should be used when the distance from the victim and the rescuers is within the length of the ladder and the rope to be used. Ladder slides are very efficient when several victims need to be moved from one elevation to another.

If an extension ladder is used, the bed and fly sections should be secured together to prevent them from shifting during positioning or raising and lowering operations.

## 3. Exterior Leaning Ladder

An exterior leaning ladder will create an anchor point that will allow access to every floor below the tip of the ladder without repositioning the ladder. If several floors have victims who need to be evacuated and a long enough ladder is available, then an exterior leaning ladder should be considered. Either belay/safety line option can be used for the exterior leaning ladder.

Exterior leaning ladders should be used when the location of the victim is below the length of a long ladder and there are not enough available personnel for a ladder slide system. This system allows the rescue team to set up the ladder in one location and access or evacuate every floor below the top of the ladder.

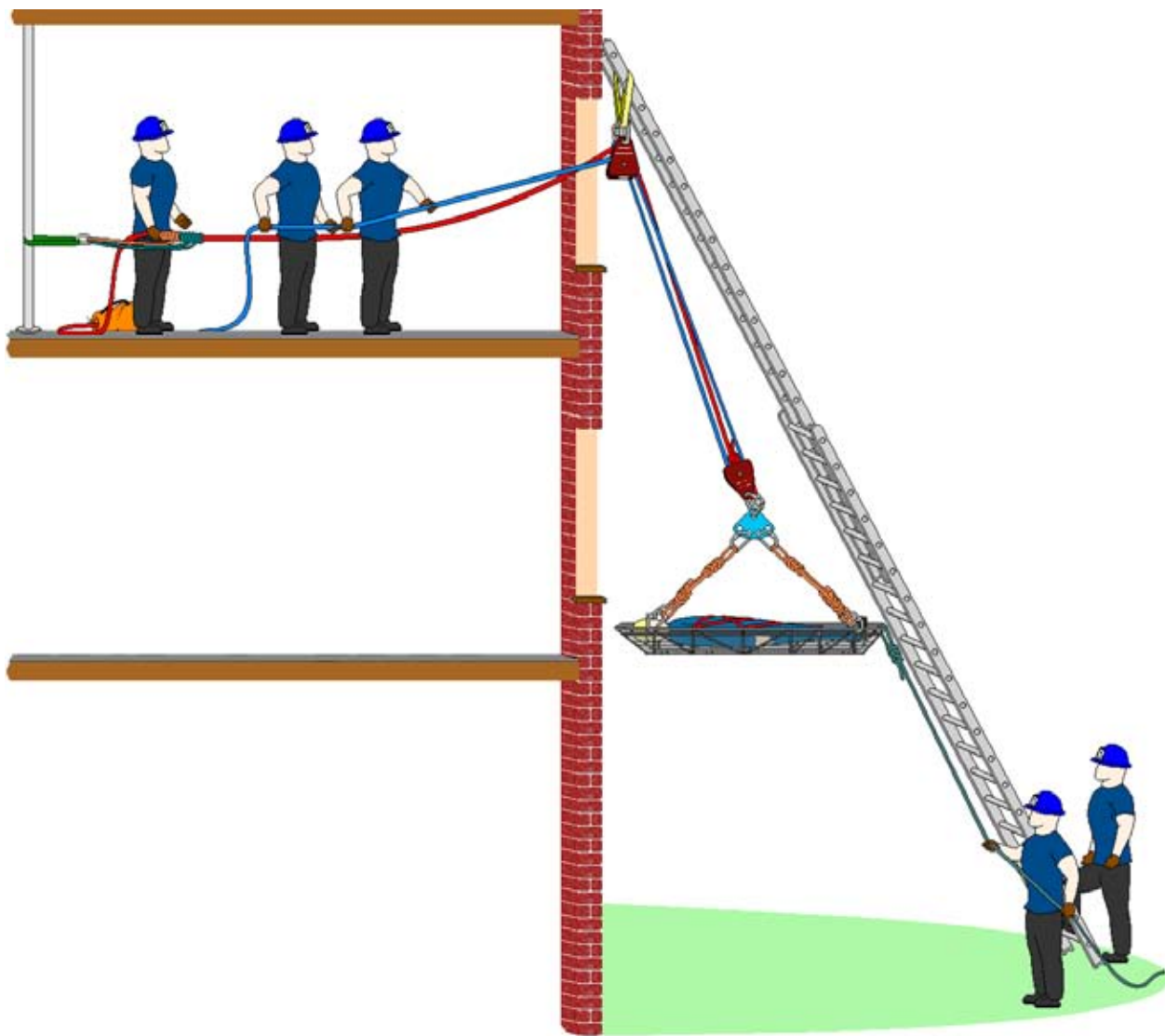


Figure 5:10



## 4. Interior Leaning Ladder

An interior leaning ladder will create a solid anchor point inside a building that will allow rescue teams to access every floor below them. A roof ladder is wedged between the ceiling and the floor and footed to maintain its position. Unlike an exterior leaning ladder, the only limitation is the length of your rope. The rope is reeved around the ladder rungs for friction. Start with a Figure Eight on a Bight tied in the end of the rope. Pass the knotted end of the rope under the bottom rung and up between the second and third rung. Pass the rope around the bottom rung again then up between the second and third rung. Next, pass the rope down between the first and second rung from the top of the ladder. The higher this directional change the better. The rope should be positioned so it runs next to one of the ladder beams since the rungs are stronger there. **For wood ladders, use the frictioning carabiner method of reeving the rope.**

A separate anchor point is used for the belay/safety line on the interior leaning ladder. The belay/safety line should pass out the window and not be reeved through the ladder. Again, a secure anchor, tandem prusik belay, and load-releasing hitch manage the belay. This should be at or above the departure level, never below.

An interior leaning ladder can be used to create an anchor point for lowering victims or rescuers out of a window opening or from any level directly below the ladder position. The only limit is the length of the rope.

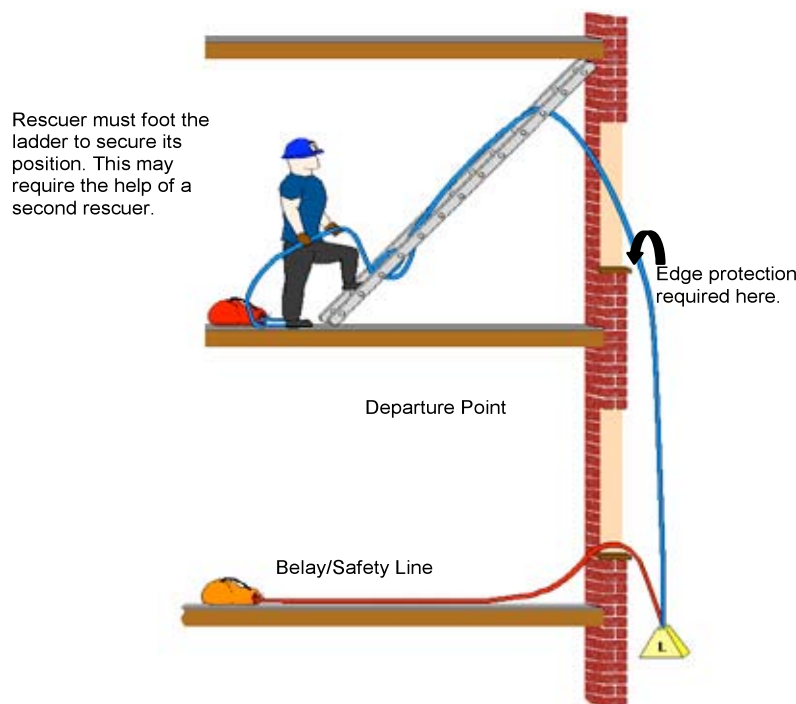


Figure 5:11 Interior leaning ladder with optional Friction carabiners as 1:2:1 friction system

## 5. Cantilever Ladder

The cantilever ladder is used to create an anchor point above the floor that the rescue team is working from. It is used when the distance from the victim to the rescuers is farther than the length of the ladders, but is within the length of the rope being used, and an interior leaning ladder or other suitable anchor is not readily available.

The cantilever ladder does not work as an anchor point if the rescue team has to lower a victim from the level on which the cantilever is set up. It is designed only to provide an anchor point at a location above the position from which the rescue team wishes to work.

By placing a fire service ladder over a parapet wall, a windowsill, or roof edge a very strong anchor point is created as long as these basic rules are followed:

1. The directional change of the rope or ladder sling on the ladder should be no more than one rung beyond the edge upon which ladder beams rest.
2. A counterweight rescuer must be in place, with his or her weight on the butt end of the ladder.
3. To maintain the correct counterweight loading, the ladder must have a minimum of seven (7) rungs inside the building from its point of contact.
4. The counterweight rescuer must not move off the ladder until directed to do so by the team leader, and only after the load is off the ladder.

The cantilever ladder will have the belay/safety line anchored on either the roof or floor that the ladder is on or on the floor the litter is being passed from. A secure anchor, tandem prusik belay, and load-releasing hitch are used.

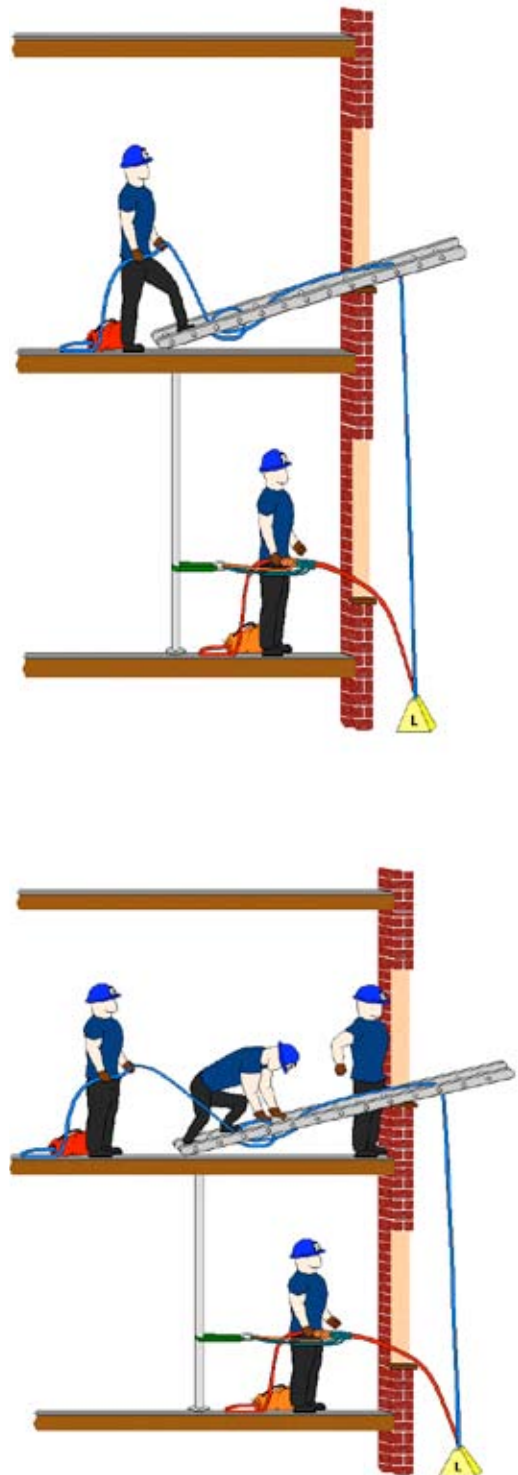


Figure 5:12

## ***Cantilever Ladder with 2:1 Ladder Rig without Pulley(s)***

A cantilever ladder creates the same type of anchors when used on flat roofs or floors with no walls or raised edges.

1. The ladder sling on the ladder should not be more than one rung beyond the edge upon which ladder beams rest.
2. The ladder rig pulley system is attached to the ladder sling.
3. A counterweight rescuer must be in place, with his/her weight on the butt end of the ladder.
4. To maintain correct counterweight loading, the ladder must have a minimum of seven (7) rungs back from the edge or contact point.
5. The counterweight rescuer must not move off the ladder until directed to do so by the team leader, and only after the load is off the ladder.

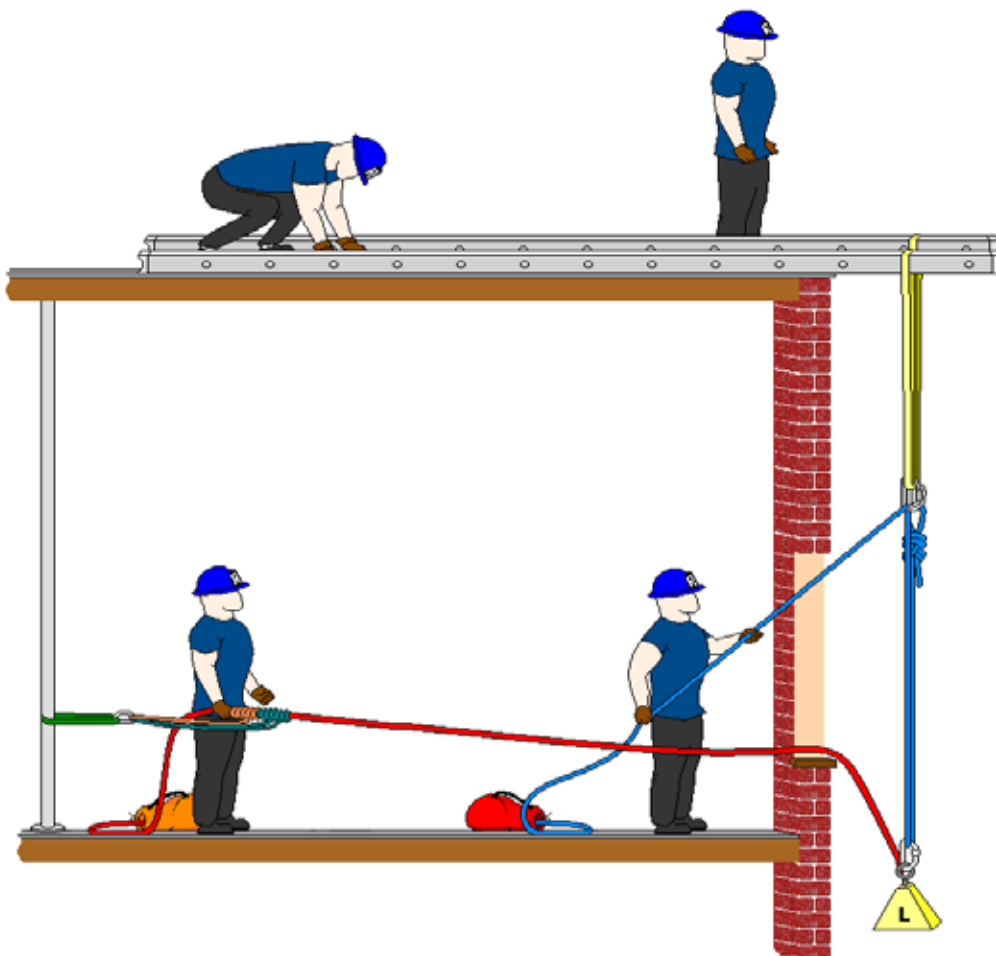


Figure 5:13

## ***Slinging a Spar (Optional)***

During a major disaster, it may be necessary to construct a rescue system out of debris. The ability to use a 4x4 piece of lumber or a piece of steel pipe as a spar, and the ability to sling it in order to attach equipment, will be of great use to the rescuer. A slung spar, when done correctly, will create a solid anchor point that can be used inside a structure to lower victims from upper floors. If a fire service ground ladder is available, it can be used like a spar also.

Slinging a spar requires the rescuer to:

1. Obtain a suitable spar, either a 4x4 x approximately 8-foot piece of lumber (preferably Douglas fir), or a 1½"-diameter, Schedule 40 or greater piece of steel pipe, approximately 8' in length.
2. Lean the spar against the structure at a 75° climbing angle.
3. Sling the top and bottom of the spar with 12' pieces of webbing, by using the three-wrap prusik hitch.
4. The webbing should be located no more than 12" from each end of the spar.
5. When wrapping is completed, the eye of the webbing should be approximately 6" long.
6. Attach two carabiners to each sling.
7. These will be used for friction to lower the victims.
8. Tie a Figure Eight on a Bight in one end of a rescue rope and clip the running end of the rope through one of the carabiners in the top sling and lock the gate.
9. Reeve the standing end of the rope through both carabiners that are attached to the bottom sling and lock their gates.
10. Clip the standing end of the rope through the remaining unused carabiner attached to the top sling and lock the carabiner creating a 1:2:1.
11. Set up belay/safety system from a different anchor, but on the floor of departure of the victim.
12. The system should be safety checked and then operated.

### ADDITIONAL FRICTION

Optional Methods  
(Figure Eight Plate)  
(Brake Bar Rack)  
(Opposing Carabiners)  
(1:2:1)

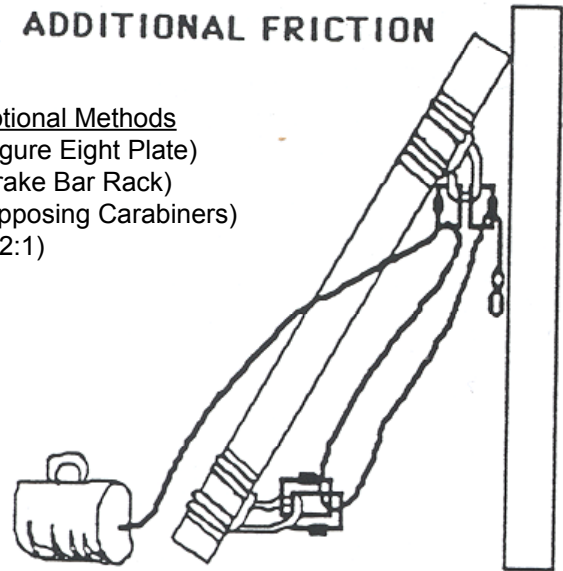


Figure 5:14 Slinging a Spar

## 6. Ladder Gin

A ladder gin is an upright ladder supported at the top to keep it in a near-vertical position. When a mechanical advantage (pulley) system is added, it creates a machine for hoisting equipment, one rescuer, or one victim.

It can be a very useful rescue device, since it requires a minimum of equipment and has numerous applications. It can be constructed in an open field to gain access to open pits, wells, vertical shafts, or utility vaults. It can be built against a building, a vehicle, or a curb, or it can be built to extend out a window or off a roof.

- ❑ A ladder gin needs to be rigged at the proper climbing angle of 75° in order to support the maximum load.
- ❑ All loads must be kept within the ladder beams, since a ladder gin will not accept side-loading.
- ❑ The guy lines are intended to support the ladder and not the load; the ladder beams support the load.
- ❑ An improper angle, too much weight, improper rigging, or side-loading can cause a ladder gin to fail.

A change-of-direction pulley located on an independent anchor at the foot of the ladder will allow Hauling Team personnel to move to one side and give them more room to work. This change-of-direction pulley must be secured to a good anchor so the force of hauling on the load does not dislodge the base of the ladder or side-load the system.

### ***Components of a Ladder Gin***

#### ***Ground Ladder***

A ground ladder must satisfy NFPA standards for fire service ladders (Standards 1931 and 1932) in annual testing and regular, routine maintenance. A 12- to 16-foot straight ladder works best. Extension ladders can also be used when maximum extended height is kept as short as possible.

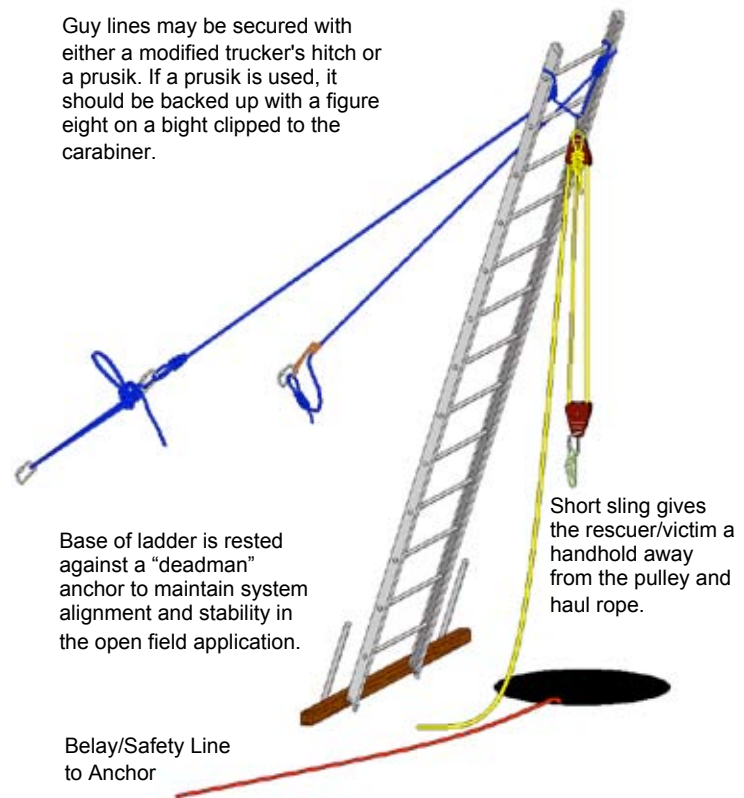


Figure 5:15 Ladder Gin

## *Guy Lines*

Guy lines are rigged from a single lifeline rope, since the main hauling system is attached to the center of this line. Guy lines hold the ladder at or near the 75° climbing angle when the gin is loaded. A guy line rope should be a minimum of 150' long. The guy lines run from the top of a ladder at about a 45° angle to the anchor points in order to create the best support. Guy lines are rigged by tying two Figure Eight on a Bight knots with 12" bights. These knots are tied 12" to 18" from either side of the rope's center point, depending on the width of the ladder from beam to beam. Key point: Tie the knot at a distance from the center of the rope that will keep the attachment point angle less than 90° degrees. The bights are placed under the top rung of the ladder from the backside and then looped over the tips. The guy lines are tensioned using a modified Trucker's hitch or a prusik hitch that is backed up with a Figure Eight on a Bight.

## *Anchor Points*

Anchor points for ladder gins should be located at a distance equal to three times the length of the ladder and away from the base of the ladder.

Guy lines are attached to the pump suction ports on each side of the apparatus and adjusted using the modified trucker's hitch or prusik.

A ladder gin is not designed to support a side load. Therefore, both the load and the haul must be kept in line between the ladders beams.



Figure 5:16 Ladder Gin against a Vehicle

## 7. Ladder “A” Frame

Ladder “A” frames are versatile rescue tools. They are easy to set up, easy to operate, and, unlike the ladder gin, can be portable depending on the application. They can be used for high points to access utility vaults, wells, narrow pits, vertical shafts, tanks, and vessels.

- ❑ Rig both ladders at 75° angles.
- ❑ Keep the load between the ladder beams.
- ❑ Raise the load only as high as needed to clear the opening.

### Ladder “A” Frame Components

#### Fire Service Ladders

Two ladders are required. Ladders of equal or unequal length can be used, and extension ladders up to 35' can be used. They need to satisfy NFPA standards for fire service ladders (Standards 1931 and 1932) in annual testing and regular, routine maintenance. Ladders are tightly lashed together at the top using the round lash without the frapping. Once erected, a 20-foot webbing is tied at the base of each ladder to maintain the 75° climbing angle.

#### Guy Lines

The guy lines are rigged from a single life safety rope and used to stabilize the ladders and to prevent side-to-side movement. Guy lines are rigged by tying two Figure Eight on a Bight knots with 12" bights. These knots are tied 12" to 18" from either side of the rope’s center point, depending on the width of the ladder from beam to beam. Key point: Tie the knot at a distance from the center of the rope that will keep the attachment point angle less than 90° degrees. The mechanical advantage pulley system is also attached to the guy line as in the ladder gin. The guy line needs to be long enough to extend out to anchors that are located at a distance equal to three times the height of the ladders on both sides of the “A” frame. These are tensioned using a modified Trucker’s hitch or a prusik hitch that is backed up with a Figure Eight on a Bight.

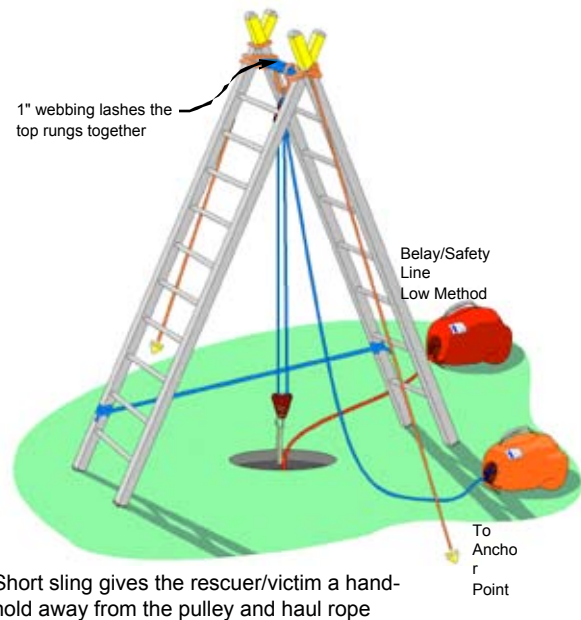


Figure 5:17 Ladder “A” Frame: Ladders of Equal Length

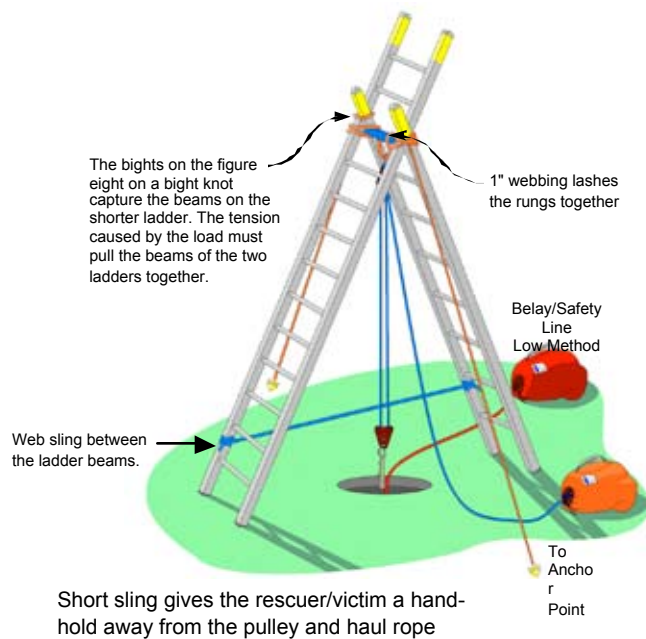


Figure 5:18 Ladder “A” Frame: Ladders of Unequal Length

## Topic 6-1: Introduction to Structure Shoring Systems

**Scope:** This chapter serves as an introduction to Structural Shoring systems.

**Terminal Learning Objective (TLO):** At the end of this chapter, the student will be familiar with the skills and techniques to stabilize compromised light-frame structures and safely operate around them.

**Enabling Learning Objectives (ELO):**

1. Describe the techniques to mitigate structure collapse hazards.
2. Describe the steps involved during shoring size-up.
3. Describe different shoring size-up considerations.
4. Describe the proper placement of shoring components.
5. Describe the positions, roles, and responsibilities of the Shoring Team.
6. Describe the different types of shoring systems.

Because of the dangerous consequences of structure collapse hazards, every effort should be made to mitigate those hazards. The four methods used to mitigate structure collapse hazards are: avoid it, remove it, shore it, and monitor it. Each method requires a different amount of time and materials. Restricting access around a collapse hazard is a priority. Using barrier tape or posting guards will eliminate the potential problem of having to manage additional civilian or rescuer injuries that may occur. Rescuers can also remove hazards to minimize collapse hazards. Chimneys or walls can be pulled down safely to prevent further collapse that may entrap or injure additional victims or rescuers. Constructing shoring systems usually takes the most time and materials. Constant monitoring of the structure and the shoring system should occur throughout the rescue operation to ensure stability and safety.



Figure 6:1 Light-Frame Collapse





Figure 6:2 Fall Hazards

The size and the type of shoring system depend on the weight and condition of the structural element to be supported by the shore. For example, a wood floor would require a different EBS system than would a broken concrete slab. Unseen fractures, forces caused by debris and gravity, and the structural components being subjected to forces they were not designed to support make assessing the collapsed structure very complex. A large safety margin to protect the rescuer should be mandatory for all shoring materials and systems due to the complex dynamics of the collapsed structure.

Rescuers should also consider the amount of materials available, the abilities of the personnel on scene, and the time it takes to construct and place the shores before beginning the shoring operations. Proper shoring operations can take large amounts of materials and considerable time to install. The use of more shores than you may think necessary is more appropriate than using fewer shores to gain time.

## **Shoring Size-Up**

The shoring size-up provides vital information that can increase rescuer and victim safety and rescuer effectiveness during a shoring operation. The size-up identifies structural hazards, damage, and potential victim locations and determines hazard mitigation methods and shoring needs. A thorough size-up will make the rescue operation more efficient. The shoring size-up must be extensive, accurate, and continuous throughout the rescue operation.



Figure 6:3 Light-Frame Collapse

Structure shoring systems or emergency building shores (EBS) are temporary building supports used during search and rescue operations after a collapse. EBS systems are necessary when rescue workers must operate in areas of high secondary collapse potential. Rescue operations within void spaces, next to weakened walls, or under overhanging floor slabs may all require the application of EBS systems.

In order for EBS systems to be effective, the materials used should be strong, lightweight, and adjustable.



Figure 6:4 Collapse on a Victim

## Victim Consideration

In a disaster such as an earthquake, how much time and effort rescuers place on a collapsed structure can depend on the potential number of live victims that can be rescued from the collapse. Information leading to the number of victims and where they may have been located in a structure prior to the collapse can be of key importance in the efficiency of a rescue operation. Reliable information can be gathered from bystanders, site managers, law enforcement personnel, medical personnel, and, most importantly, from victims already recovered from the collapse.

## Six-Sided Approach

To survey a collapse structure, a six-sided approach should be used—the four separate sides, the top, and the bottom of the structure. By walking around the collapse, the four sides are the easiest to assess. However, the sides that are the most critical for the rescuer’s consideration are the top and bottom of the collapse. These two “sides” are also the most difficult to access and evaluate.

The top of the collapse is considered by some rescuers to be the most dangerous “side.” Since gravity is always at work and collapse occurs from above, it is imperative to monitor and survey the overhead area constantly to assess the potential for fall hazards or secondary movement.

The second most important “side” is the bottom of the collapse. Shifting loads and the integrity of the bottom supporting structures or surfaces need to be evaluated. It is important for rescuers to check the condition of floors, building piers, basements, and foundations before installing EBS systems. These areas may have been compromised during the collapse and may require close evaluation before using any shoring operation that applies additional loads to an already compromised condition. Shored loads must be transferred to stable surfaces for the shoring system to adequately perform.



Figure 6:5 Sides of a Collapse



Figure 6:6 Compromised First Story

## Structural Elements

Basic elements of a structure should be evaluated. These elements can be bearing walls, columns, beams, arches, joists, floors, and ceilings.

Bearing walls are one of the most important structural elements, especially in an unframed building. Walls out of plumb or damaged by an event can affect the stability of the rest of the structure. Bearing walls usually support floors and roofs, but in collapse conditions non-load-bearing walls may become load-supporting walls that now have a greater chance of failure and further collapse.

Assessment of all beams, columns, arches, joists, and other structural supporting elements under the main debris pile or victim's location should be the top priorities of the shoring size-up. All severely stressed, broken, missing, bowed, or cracked supporting elements that could affect the rescue operation must be shored up before any personnel are committed to work in the area.

## Age and Condition of a Structure

Like the human body that becomes frail as it gets older, a structure fatigues or weakens with age. Structural elements such as concrete or metal hangers can fatigue, loosen, and crack from repetitive loads. Natural conditions like water damage, dry rot, burrowing animals, and insects such as termites reduce the strength of materials. Some remodel work can also compromise the integrity of structural elements if completed improperly. Because of the potential for the strength of structural elements to be compromised, every element should be evaluated before committing resources in a shoring operation.

## Collapse Warning Signs

Collapse warning indicators are often the best method to evaluate the condition of the structure. If a structure begins to make noises and “talks” to you, it may indicate an overstressed or a failing condition. Creaking, moaning, or groaning sounds may be caused by nails being pulled, concrete cracking or sliding, glass breaking, or steel bending. The production of airborne dust not related to wind or rescue operations may also indicate imminent failure. Rescuers must react to a situation that may require more shoring or immediate evacuation. When this “warning noise” concept is applied to shoring systems, it can serve as an effective method to alert rescuers that a shoring system is being overloaded.



Figure 6:7 Unsupported Bearing Walls



Figure 6:9 Theodolite

Sensitive instruments like surveyor transits and theodolites (Figure 6.9), when properly used by trained individuals, can detect very small movements of structural elements. Structural engineers, construction personnel, and some public works personnel are trained and may have access to these instruments. If none of these high-tech devices are available, low-tech methods like drawing chalk lines over cracks and watching the lines move out of alignment or using an observer to watch for simple movement can assist with the monitoring of potential collapse situations.

## Shoring Placement Considerations

The two main objectives for proper shoring placement are maintaining the integrity of the structural elements and properly transmitting or redirecting the collapse loads to a stable surface or structure capable of handling the additional loads. Shoring systems should not increase the damage to either the object to be shored or to the object the load is being transferred to.

Shoring systems should be applied gently to the structure they are to support. Emergency shores are **not** designed to move structural elements back to their original positions or design. If rescuers attempt this, they can cause additional collapse or damage to the object they are trying to support.



Figure 6:8 Monitoring a Collapse



Figure 6:10 Alignment of Shore



Figure 6:11 Hanging Debris

Collapsed structures can be unstable laterally as well as vertically. Interconnected building parts may depend on each other for support, which may create a difficult shoring situation. A piece of debris that appears to be simply hanging in place may also be providing counterweight or forces that are helping to keep another part of the collapsed structure from moving elsewhere. Careless shoring or removal of the overhead hazard in this situation may cause movement in another part of the collapse. Partial collapses that leave large sections of the building standing (such as freestanding walls, overhanging floors, or large hanging building components) can be very dangerous.

The type of building construction may dictate the extent of shoring needed to support the compromised structure. In rescue operations occurring in wood or lightweight steel-frame structures, shoring should start at least **one (1) floor below** the floor with damage. When dealing with concrete structures, shoring should start at least **three (3) good floors** below the level in which structural damage has occurred.

Placing the shores under primary structural elements such as bearing walls, beams, columns, and arches will more effectively use shoring materials and the existing construction features of the building. An example would be to shore a roof span under a damaged, but intact, beam. Placing a solid supporting shore under a beam will allow the beam to support the attached roof section as it was designed. If the beam connection and roof sections are still connected properly, no other shore may be necessary. If shores were placed to support the same collapsed roof section under the sections and not under the beam, more shores would be needed to effectively shore and stabilize the collapsed roof area.

The area under the main debris pile and directly underneath victims or the rescuers must be inspected and shored before the start of any operation. Shoring systems must also be located so they do not interfere with the removal of the victims and the movement of the rescuers and equipment that need to be taken into the collapse area.

Some shoring operations may require multiple floors to be shored. Under these situations, shores on different floors or levels need to be aligned above and below each other to ensure the effective transfer of the load to the ground. If the shores do not line up, the shore above can overload the support surface it sits on and cause a failure of the shoring system.

Access into the building may require shoring to be started from the point of entry to where the victim is located in the structure. A primary consideration when working in areas with multiple shores is to keep the egress pathways clear for immediate rescuer evacuation, if necessary. When clear pathways are not achievable, reinforced safe zones should be constructed.

## The Shoring Team

To conduct safe and efficient shoring operations, a shoring team is formed with a Shore Assembly Team and a Cutting Team. The Shore Assembly Team performs the actual shoring size-up, takes measurements, and clears the area and constructs the shores. The initial responsibility of the Cutting Team is to establish a work site to manage the tools, equipment, and materials to be used. The work site should be set up in a safe location as close as possible to the collapse area. This will minimize the number of personnel needed to relay the materials to the Shore Assembly Team. The work site should have adequate room for laying out the materials and equipment in an organized fashion. A tarp or salvage cover has proved to work well as a ground cover to protect equipment and to help identify the workstation location. A simple cutting table can be constructed on site to enhance the safety and ease of cutting lumber. Shoring materials and tools should be stockpiled in this area for safe access and efficient use.



Figure 6:12 Pre-Constructed Door



Figure 6:13 Shore Assembly Team

## The Shore Assembly Team

- The **Shoring Officer** is in charge of the assembly operation and may work with a Structures Specialist to determine what shore to use and where to place it.
- The **Safety Officer** is assigned by the Shoring Officer as needed.
- The **Shore Assembly Team** performs the following duties:
  - Performs all measuring, deducts for component pieces, relays information to the Cutting Team
  - Clears debris, builds the shore
  - Moves lumber and equipment as needed
  - Communicates with the Cutting Team

## The Cutting Team

- The **Cutting Officer** is in charge of the Cutting Team. This position can be eliminated in a smaller team configuration.
- The **Cutting Team** performs the following duties:
  - Sets up cutting station and lumber cache
  - Equipment and logistical needs
  - Measures, marks and cuts lumber
  - Moves lumber and equipment to the Shoring Team
  - Communicates with the Shoring Team



Figure 6:14 Cutting Team

Larger and more complex shoring operations may require the Shore Assembly Team and the Cutting Team to be assigned more persons for each position.

## **Shoring Systems**

A shoring system, as it applies to rescue, is the temporary support of only that part of a damaged, collapsed, or partially collapsed structure that is required for conducting search and rescue operations at reduced risk to the rescuer and victim.

## **Double Funnel Principle**

Emergency shoring systems must be designed like a double funnel. The systems are designed to:

- Collect the load with a header beam or wall plate
- Support the load with posts, struts, or rakers
- Distribute the load to the supporting structure below or to the opposite side through a sole plate or wall plate over a wide area

Heavily loaded shoring components such as posts or struts can punch through the structural elements they are supporting if the loads are not adequately distributed.

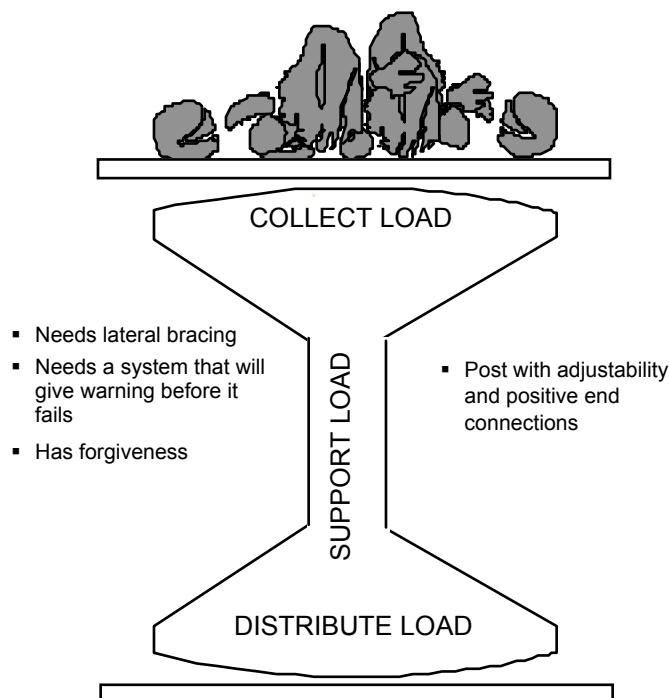


Figure 6:15 Double Funnel





# RESCUE SYSTEMS 1

## Basic Rescue Skills



### Topic 6-1: Introduction to Structure Shoring Systems

## Shoring System Design Principles

All components of the shoring systems must be able to carry the weight of the anticipated load. If one component is weak, the entire shore may fail. These components that collect, support, and distribute the load need to be adjustable so they fit into the uneven surfaces that are produced by the collapse. The shores must also be able to withstand movements in multiple directions caused by the dynamic nature of the collapse situation.

In order for emergency building shores to perform to their best ability, shoring components must be constructed as plumb and level as possible. Damaged and collapsed structures usually have uneven surfaces to shore against. The rescuer must use wedges and backfill material between the compromised structure and the shoring components to keep the shore as plumb and level as possible and maintain full surface contact. Maintaining full surface contact between the shoring components ensures that the load-bearing surfaces are capable of supporting their complete capacity.

## Common Shore Components

Rescuers should be familiar with the terminology used to describe the shore components.

- Backfill material** is any material used to take up space or fill gaps between shoring components and the object being shored.
- Cleats** are small pieces of wood used to secure other parts of a shoring system in place.
- Diagonal braces or “X” and “V” braces** prevent shores from racking (becoming a parallelogram) and buckling (bending and breaking).
- Gusset plates** are square, rectangular or triangular pieces of  $\frac{3}{4}$ " plywood nailed to secure shoring component junctions or connection points together.
- Header** is the uppermost element of the shore. It collects the load and transfers the load onto the post or strut.
- Horizontal strut** is the horizontal load-bearing member placed between two wall plates.
- Raker** is the diagonal strut that supports the load from the wall plate and transfers the load to the sole plate, trough or u-channel.
- Sole plate** distributes the transferred load delivered by the posts or struts on to the supporting surface.
- Vertical post** is the load-bearing member that receives the load from the header and transfers it to the supporting surface.
- Wall plate** is similar to the header beam, but it is applied vertically against wall surfaces.
- Wedges** are used to snug up loads, pressurize shores, fill in voids, or change the angle of a crib bed.



# RESCUE SYSTEMS 1

## Basic Rescue Skills



### Topic 6-1: Introduction to Structure Shoring Systems

#### **Considerations for Shoring System Design**

Prior to the installation of a shoring system, the structure and integrity of primary supporting elements must be evaluated, movement and direction of load forces anticipated, and the weight of the area to be shored estimated. The weight or load of the area to be shored is measured in pounds per cubic foot (PCF) or pounds per square foot (PSF). The weight or load of an area may change with the additional weight of transferred loads caused by shoring systems, the number of rescuers or equipment in use, secondary collapse, and the removal of debris or other building contents.

#### **Weights of Common Building Materials**

- Concrete = 150 PCF
- Masonry = 125 PCF
- Wood = 35 PCF
- Steel = 490 PCF
- Concrete, masonry and rubble = 10 PSF per inch of thickness

#### **Weights of Common Building Construction**

- Concrete floors = 90 to 150 PSF
  - Steel beam with concrete-filled metal deck = 50 to 70 PSF
  - Wood floors = 10 to 25 PSF
  - Wood floors with thin concrete fill = 25+ PSF
- \*Add 10 to 15 PSF for wood or metal stud interior wall per each floor level.  
\*Add 10+ PSF for furniture and contents per each floor level.

#### **Example: Estimated Floor Weight Calculation**

- Size of wood floor
    - 20' by 20' =  $20 \times 20 = 400$  sq. ft.
  - Weight of wood floor
    - 25 PSF =  $400 \times 25 = 10,000$  pounds
  - Weight of contents
    - 10 PSF =  $10 \times 400 = 4,000$  pounds
  - Total floor weight
    - 4,000 pounds + 10,000 pounds = 14,000 pounds
- + Add weight of rescuers (250 pounds each) and equipment to total.



# RESCUE SYSTEMS 1

## Basic Rescue Skills



### Topic 6-1: Introduction to Structure Shoring Systems

## **Shoring System Materials**

### **Lumber**

Emergency shoring systems can be constructed from metal, a combination of metal and wood, or entirely of wooden components. Wood shoring supplies are readily available from lumberyards, home supply stores, or public works departments. Debris lumber can also be acquired from surrounding structures and wood 4x4 signposts, or lumber cut from a nearby fence, deck, or porch may also be available.

Douglas fir and Southern pine are two of the most common lumber types used. Dimensional lumber is most often used in the following sizes: 2x4, 2x6, 4x4. The actual dimension is  $\frac{1}{2}$ " less than the "call out" size:  $4x4 = 3.5x3.5$ .

Lumber has varying strength characteristics depending on its size and how it is used. Lumber placed on end (end-grain) has different load capabilities than the same lumber on its side orientated with the grain (cross-grain). The average end-grain strength of lumber is 1,000 PSI (pounds per square inch). The load capacity of a 4"x4" vertical post with end-grain compression is, however, dependent on its length. Bending and breaking characteristics of upright posts need to be considered. The load capacity of lumber is relative to its length and width ratio. The ratio between the length and width or diameter (L/D) should never exceed a minimum of 50 for normal building construction. The ideal ratio in a rescue operation should be 25 or less. So, the maximum length of a 4x4 (L/D50) is  $50 \times 3.5" = 175"$  or 14.5'. The ideal length of a 4x4 for rescue operations (L/D25) is  $25 \times 3.5" = 88"$  or approximately 8'. The average cross-grain strength is 500 PSI. The load capacity of a 4x4 used as a crib member with cross-grain compression will be able to support approximately 6,000 pounds per contact point ( $3.5" \times 3.5" = 12.25" \times 500 \text{ PSI} = 6,125$  or approximately 6,000 pounds per contact point). Other considerations for lumber strength can include the moisture content, age of the lumber, knots, and the density of growth rings.

When considering compression loads versus tension loads, it is recommended that 4" lumber minimum be used for compression loads and 2" minimum lumber should be used for tension loads.

### **Plywood**

Plywood is typically composed of multiple thin layers of wood glued together so the grain direction of each layer is perpendicular to the adjacent layer. This layering pattern gives plywood its strength and ability to resist splitting like other solid pieces of lumber—thus the reason for plywood being used extensively for shear paneling or decking.

Plywood is usually constructed in 4' x 8' panels or sheets with common thickness from  $\frac{1}{4}$ " to  $\frac{3}{4}$ ". Plywood sheets are produced in a variety of grades for exterior and interior use. A typical  $\frac{3}{4}$ " sheet of plywood is usually made of five layers. Plywood used for shoring material is  $\frac{3}{4}$ " thick to provide adequate strength comparable to the other shoring components.

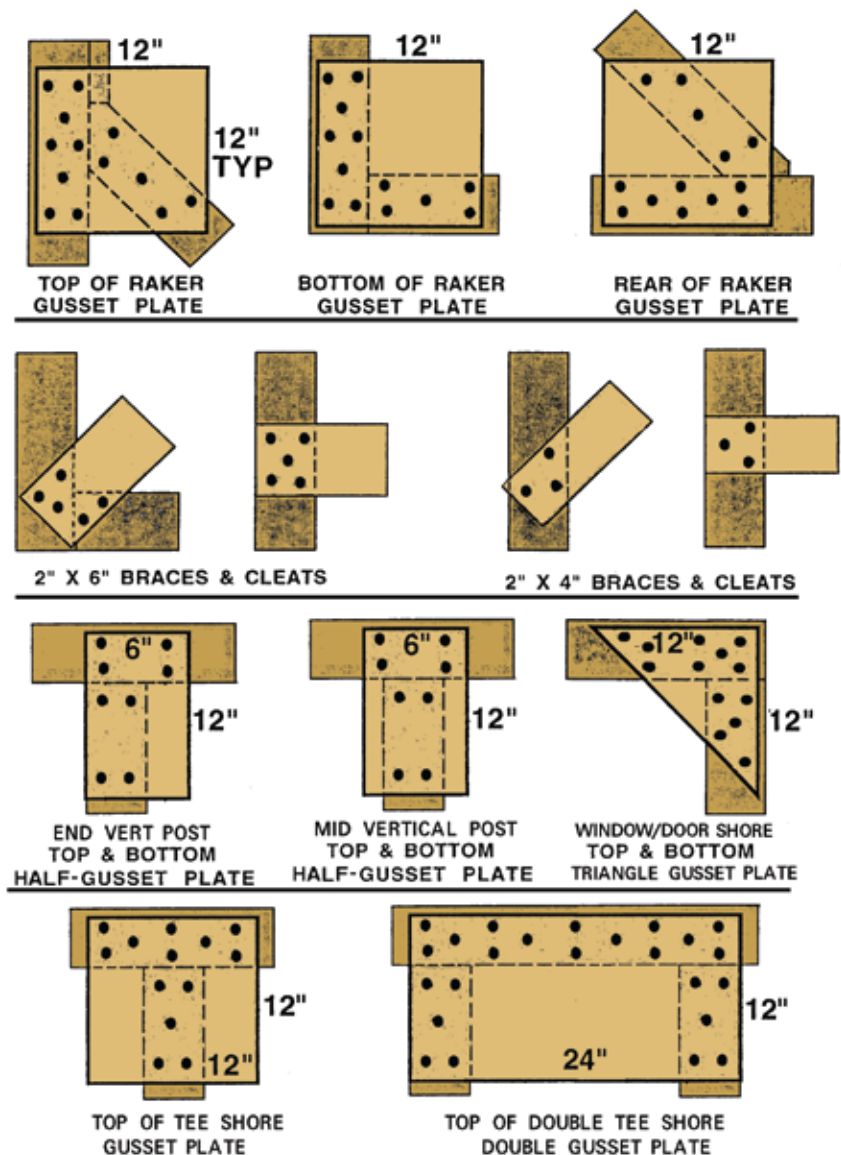
## Nails and Nail Patterns

Nails come in different shapes, sizes, and strengths. The nails used in emergency shoring operations can be either single-head or double-head (duplex) nails. Single-head nails can be used when it is desired to have the top of the nail flush with the surface of the lumber; however, it is very difficult to remove these nails after application, if necessary. Duplex nails have two heads so when the nail is hammered into the lumber, the nail stops at the first head and keeps the top nail head still exposed, making these nails much easier to remove if needed.

Nails come in different lengths and thickness. The most common nails used to construct shoring systems are 8-penny and 16-penny (d) nails. It is estimated that the shear/pulling strength of the 8d nail is 150 pounds and the 16d nail is 225 pounds. Use 8d nails on plywood and 16d nails on 2" lumber. The proper size, amount, and spacing of nails must be properly applied when attaching shoring components to ensure that the collective strength of the nails is adequate for the design of the shore and to prevent the nails from weakening (splitting) the lumber.

A 3-nail or 5-nail pattern system is used in emergency shoring operations. Figure 6:16 illustrates the different variations of the nail pattern when connecting different shoring components. When nailing lumber such as 2x4 or 2x6, the amount of nails used is usually one nail less than the width of the lumber. Example: three (3) nails for a 2x4 or five (5) nails for a 2x6.

Figure 6:16  
Nail Patterns for  
3/4"x12"x12" & 3/4"x6"x12" Plywood  
Gusset Plates and Triangles / Braces and Cleats  
(Use 8d nails on plywood and 16d nails on 2" lumber)



## Shoring Systems

### **Spot Shore – Class I**

The spot shore is used to initially stabilize damaged floors, ceilings, or roofs so more substantial shoring can be installed at less risk to the rescuers and victims. It is constructed from a single vertical post with a header plate and sole plate to collect and redistribute the load.

The spot shore is basically unstable. If the load shifts and leans the post over to one side or the load is not centered directly over the shore, it has a tendency to tip over. The spot shore needs to be backed up with other shoring systems that provide increased lateral stability and load capacity. Even with its inherent instability, the spot shore is widely used by rescuers as one of the first shores installed.



Figure 6:17 Spot Shore (Class I)



Figure 6:18 Two-post Vertical Shore (Class II)

### **Two-Post Vertical Shore – Class II**

The vertical shore is used to stabilize damaged floors, ceilings, or roofs. It can be used to replace missing or unstable load-bearing walls or columns. It is constructed with two posts, a common header plate and sole plate, and midpoint and diagonal braces to resist lateral forces.

### **Horizontal Shore – Class II**

The horizontal shore is used to stabilize damaged walls against an undamaged wall in hallways, in corridors, or between buildings. It is constructed similar to the vertical shore, in the horizontal position.



Figure 6:19 Horizontal Shore

## Window and Door Shore

The window and door shore is used to stabilize windows, doorways, or other access ways. It is usually installed to protect entryways intended for use by rescuers or in openings that have sustained structural damage.

## Sloped Surface with Cribbing



Figure 6:20 .

A sloped surface crib bed can be constructed with cribbing and wedges. It is a quick and effective method of shoring that can be adjusted to various heights and sloped surfaces.

## Raker Shore – Class III

The raker shore is used to support leaning or unstable walls and columns by transferring the lateral forces to the ground. They are always installed in series—connecting at least two rakers together. The two general styles of rakers most often used by rescuers are the solid sole and the split sole raker. Rescue Systems 1 curriculum will teach the split sole raker only.



Figure 6:21 Window and Door Shore

## Shore Evaluation and Safety Checks

An evaluation and safety check must occur to ensure that all the shoring components are tight and secure after installation of each shore or after any significant movement from aftershocks or debris removal. Check for level and out of plumb, and fill all shoring component void spaces to ensure full surface contact. Not only do rescuers have to check the shore just installed, but they should also check the rest of the shores that were placed prior to ensure that each is still pressurized and supporting the needed weight in the collapse.



Figure 6:22 .



---

# RESCUE SYSTEMS 1

## Basic Rescue Skills

---



### Topic 6-1: Introduction to Structure Shoring Systems

---

## Topic 6-2: Introduction to Basic Tools and Equipment for Emergency Shoring Operations

**Scope:** This chapter serves as an introduction to Basic Tools and Equipment for Emergency Shoring Operations.

**Terminal Learning Objective (TLO):** At the end of this chapter, the student will be familiar with basic tools and equipment needed to construct emergency shores.

**Enabling Learning Objectives (ELO):**

1. Describe the tools and equipment for emergency shoring operations, including design, use, limitations, and applications.
2. Describe the safety considerations related to shoring tools and equipment.

The construction of emergency building shores requires proficiency in the use of carpentry hand tools and power saws. These tools are used to measure, cut, and attach the various components of a shoring system together.

### Safety Considerations

Some basic safety guidelines must be followed. Rescue personnel should be in full safety gear when working with tools. Safety glasses and hearing protection are necessary. Gloves should be required when handling lumber, but, when handling tools, it may be better for rescuers to work without gloves. Most personnel can maintain better dexterity and grip on the tools without gloves. Loose clothing can be a hazard and should be secured when using some tools, especially rotary power tools.



Figure 6:23



Figure 6:24

Personnel need to be aware of other workers in the immediate area when cutting with tools, moving lumber, and swinging hammers. Tools can slip out of hands, lumber can splinter, and saw blades can come apart and shatter or throw teeth.

The majority of injuries are a result of taking shortcuts and not enough precautions when using tools. Remember to make sure that all saw blades stop completely before the saw is put down on the ground or pulled away from the lumber. Evaluate the work area for tripping hazards, other workers, or slippery surfaces prior to starting your cutting operation.



Figure 6:25



## Hand Tools



Figure 6:26

Hand tools required to construct shoring systems with wood components include:

**Hammers:** Framing hammers weighing 20 or 22 ounces are preferred because of their superior nail-driving ability and they don't cause fatigue because they are not too heavy.

**Tape Measure:** The most common tool used to determine lumber length is a tape measure with a 1"-wide steel tape for simple-to-read measurements and a power return for easy use. The tape measure can also be used to determine the length of a raker.



Figure 6:27 Tape Measure

During construction of emergency shoring systems, a good practice is to report all measurements in inches. This reduces the chance of misunderstanding a measurement being reported over the radio or in person by someone other than the one doing the measuring. An example of this would be requesting a 4"x4" with a length of 9'6". If the measurement is reported over the radio as "one 4 by 4 by 9 6," the lumber could be cut at 96" or 114". To ensure you get the correct lumber size, report the measurement as "one 4 by 4 by 114."

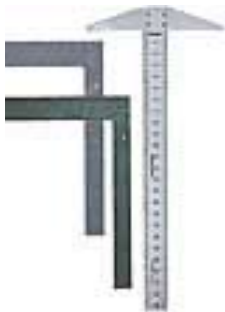


Figure 6:28

**Framing square:** A 90° "L"-shaped measuring device is used to mark square lines.

**Speed square:** This triangular tool allows the user to find various angles.

**Tri-square:** This provides for quick and easy perpendicular lines that allow the cutter to make square cuts.

**Handheld mauls (single jacks):** These mauls weigh 2 to 4 pounds each for installing wedges and demolition work.



Figure 6:29



Figure 6:30

**Nail-pulling bars:** These include wonder bars, crowbars, and small wrecking bars. Bars have better leverage than the framing hammer, which makes them tools of choice to pull nails.

**Handsaws:** Use a standard crosscut single-edge blade with medium teeth.



Figure 6:31



Figure 6:32

## Power Tools

Power saws are used to cut lumber to the dimensions needed during the construction of shoring systems. Personnel operating these saws must be familiar with the manufacturer's operating instructions and safety requirements. A preoperational check of any power saw used should be done per the manufacturer's instructions. Some of the items that need to be evaluated during this check are drive belts or chains, fluid levels, blades, cutting chains, guide bars, and air filters.

Operators of power saws must be familiar with the capabilities of these tools and be able to operate them properly. Care should be taken not to bind blades or chains during cutting operations.

Safety procedures for using power saws should be followed. This includes the use of safety equipment such as eye protection, gloves, helmet, and safety shoes. Fuel should be handled and stored in a safe manner in approved containers to eliminate the possibility of fire. Always work in a ventilated area when using and refueling gasoline-powered tools. Operators must always be aware of their surroundings when using power saws.



Figure 6:33



---

# RESCUE SYSTEMS 1

## Basic Rescue Skills

---



Topic 6-2: Introduction to Basic Tools and Equipment for Emergency Shoring Operations

---

## Topic 6-3: Introduction to the Timber Spot Shore (Class I)

**Scope:** This chapter serves as an introduction to the Timber Spot Shore.

**Terminal Learning Objective (TLO):** At the end of this chapter, the student will be familiar with the skills and techniques required to construct timber spot shores.

**Enabling Learning Objectives (ELO):**

1. Describe the uses for timber spot shores.
2. Describe the components of timber spot shores.
3. Describe the assembly procedures for timber spot shores.
4. Describe the proper placement of shoring components.
5. Describe the evaluation and safety check process for timber spot shores.

The timber spot shore is a temporary shore constructed entirely of wood components that can be installed quickly in unstable areas so the rescuers can take time to build more substantial shoring with reduced risk to the rescuers and victims. The spot shore is classified as a Class I shore because there is no lateral support for the shore.

### Components of the Timber Spot Shore

**Header:** Plate that collects the weight from above and transfers it to the vertical post. The header plate should be level and perpendicular to the post. The minimum lumber size used is 4x4. The header should be **no longer than 3'** due to the instability that occurs with longer material creating a dangerous overhang (cantilever effect) from the vertical post.

**Sole Plate:** Plate that distributes the weight being transferred from the vertical post to a stable surface. The sole plate should maintain the same length and size requirements as the header.

**Vertical Post:** Post that supports and transfers the weight from the header to the sole plate. The vertical post is placed under the header and over the sole plate in line with main structural members in the shored structure.

The post should be perpendicular to and maintain full surface contact with both the header and sole plate. The maximum length of a timber spot shore is 10'. The minimum size of the post, header, and sole plate should be not less than 4x4. When calculating



Figure 6:34 Timber Spot Shore



# RESCUE SYSTEMS 1

## Basic Rescue Skills



### Topic 6-3: Introduction to the Timber Spot Shore (Class I)

the length of the post, deductions for the thickness of the header, sole plate, and wedges need to be factored in.

**Wedges:** Inclined planes that are used to pressurize the shore or fill gaps between the shore and the structure. Wedges are used in pairs with the cut side of each wedge “married” against each other for better holding capability and for a better striking surface for the hammers when pressurizing. Deduct 1½" for 2x4 wedges and 3½" for 4x4 wedges from the length of the post.

**Gusset Plates:** 12"x12"x¾" or 6"x12"x¾" plywood pieces that secure the connections between the different parts of the shore like the header, sole plate, and the vertical post. They are connected with 8d nails to the post, header, and sole plate.

**Cleats:** Short pieces of lumber (2x4) used to support or secure shoring component parts, cut in various lengths and secured with nails. Caution should be taken when nailing cleats due to the susceptibility of the lumber to split during the nailing process.

### **Timber Spot Shore Assembly**

1. Determine where the spot shore should be built in order to reduce risk.
2. Determine the overall height of the shore area and remove the least amount of debris necessary in order to place the shore.
3. Measure and cut the proper length of the header and sole plate.
4. Measure the overall height to be shored.
5. Deduct the thickness for the header, sole plate, and wedges.
6. Measure and cut the vertical post.
7. Nail 12"x12"x¾" gusset plates on both sides of the header and post to secure the two together.
8. Position the shore and sole plate under the load.
9. Ensure the post is plumb.
10. Pressurize the spot shore with wedges.
11. Tap a duplex nail halfway into the sole plate behind each wedge.
12. Nail 6"x12"x¾" gusset plates or cleats on both sides of the sole plate to secure it to the vertical post.
13. Evaluate shore and structure.

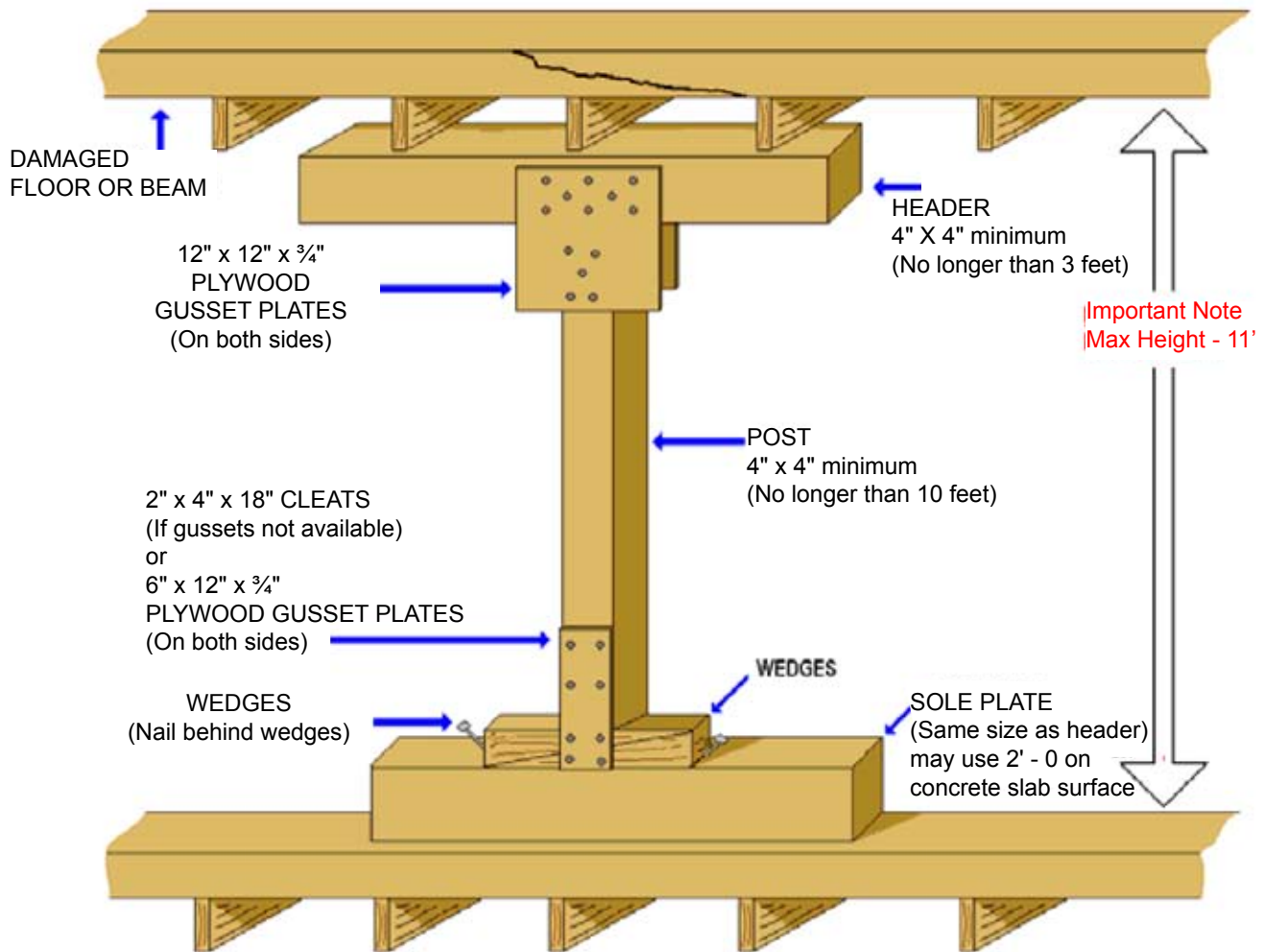
Figure 6:35

## Timber Spot Shore

Position the HEADER and SOLE PLATE across the floor and ceiling joists. Position the POST in line with the joists. Temporary shore until a complete shoring system can be erected or for temporary access to the hazard area.

(Prefabricate post and header, then install on sole.)

Temporary shore only until a complete shoring system can be erected.



Design Load\*  
1,000 to 4,000 pounds based on  
unknown stability.  
\*Load must be centered on the  
post.



To be more effective, header,  
posts, and sole plate must  
be the same width for gusset  
plates and cleats.



---

# RESCUE SYSTEMS 1

## Basic Rescue Skills

---



Topic 6-3: Introduction to the Timber Spot Shore (Class I)

---

## Topic 6-4: Introduction to the Two-Post Vertical Shore (Class II)

**Scope:** This chapter serves as an introduction to the Two-Post Vertical Shore.

**Terminal Learning Objective (TLO):** At the end of this chapter, the student will be familiar with the skills and techniques required to construct a two-post vertical shore.

**Enabling Learning Objectives (ELO):**

1. Describe the uses for a two-post vertical shore.
2. Describe the components of a two-post vertical shore.
3. Describe the assembly procedures for a two-post vertical shore.
4. Describe the proper placement of shoring components.
5. Describe the evaluation and safety check process for a two-post vertical shore.

The vertical shoring system can be used to support floors and/or roof sections that are in danger of failing. This system is often used to more securely protect rescuers operating inside collapse voids.

A vertical shoring system is comprised of multiple vertical posts under a common header and sole plate, not just a single post.

The first two posts are installed at opposite ends, 12" from each end of the header and sole plate. This clearance provides an area for the diagonal braces to attach to and maintain the maximum length requirement so failure due to the cantilever effect is minimized.

### Components of the Two-Post Vertical Shore



Figure 6.36 Two-post Vertical Shore

**Header:** Plate that collects the weight from above and transfers it to the vertical post. The header plate should be level and perpendicular to the ceiling or roof joists. The minimum lumber size used is 4x4.

**Sole Plate:** Plate that distributes the weight being transferred from the vertical posts to a stable surface. The sole plate should maintain the same requirements as the header.

**Vertical Posts:** Posts that support and transfer the weight from the header to the sole plate. The posts should be placed under the header and over the sole plate directly in line with main structural members in the shored structure (floor and ceiling joists). The posts should be separated no greater than 4' on center. They should be perpendicular to and maintain full surface contact with both the header and sole plate. The maximum length for the vertical post should be 8' unless midpoint bracing is used. The dimension and size of posts should be the same as the header and sole plate.





# RESCUE SYSTEMS 1

## Basic Rescue Skills



### Topic 6-4: Introduction to the Two-Post Vertical Shore (Class II)

**Wedges:** Inclined planes used to pressurize the shore or fill gaps between the shore and the structure. Wedges are used in pairs with the cut side of each wedge married against each other for better holding capability and for a better striking surface for the hammers when pressurizing. Deduct 1½" for 2x4 wedges and 3½" for 4x4 wedges from the length of the post.

**Gusset Plates:** 6"x12"x¾" plywood squares that secure the connections between the different parts of the shore such as the header and the vertical post. They are connected with 8d nails using a five-nail pattern. Gussets are used in joint areas that are **not** secured by the diagonal bracing.

**Cleats:** Short pieces of lumber used to support or secure shoring component parts. 2x4 material in various lengths is usually used and secured with nails. Caution should be taken when nailing cleats due to the susceptibility of the lumber to split during the nailing process.

**Diagonal Bracing:** Braces that connect the entire shore together so the posts all work as one unit. The diagonal braces provide lateral stability and prevent the shore from failing like a collapsing parallelogram. Two-post vertical shore diagonal braces span the header and post joint to the midpoint brace in one direction and the midpoint brace to the sole plate and post joint in the opposite direction on the same side of the shore. The diagonal braces would form a "K" configuration. A two-post vertical shore with posts less than or equal to 7'6" long can use a single diagonal brace spanning the entire length of the shore connecting the header and post and sole plate and post joint without a midpoint brace.

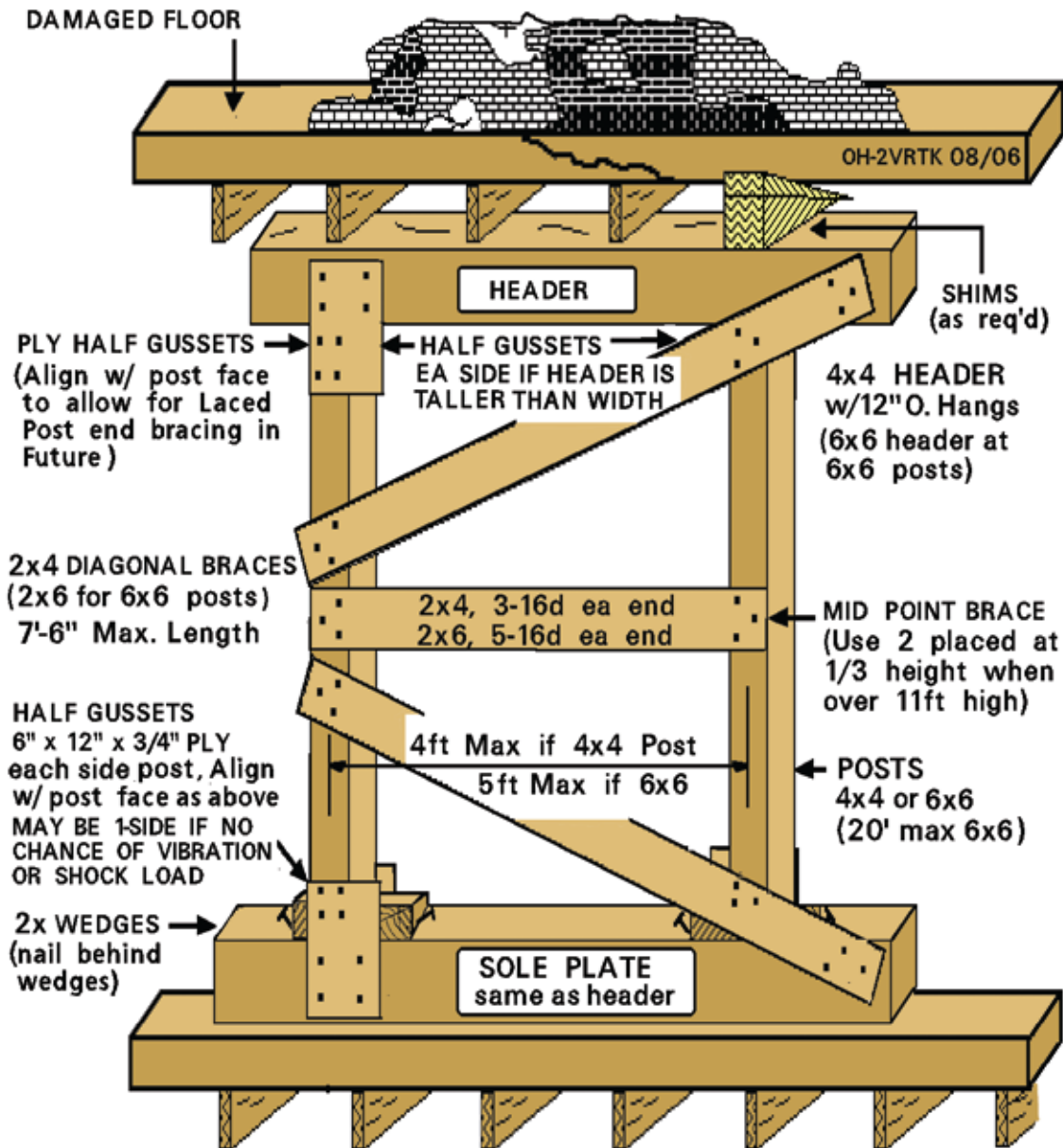
**Midpoint Brace:** Brace that increases the load-bearing capacity of the posts by resisting the buckling effect and the tendency for long posts to bend and break when put under pressure. Two-post vertical shores with 4x4 posts greater than 6' and less than 12' long require a single midpoint brace on one side of the shore. Two-post vertical shores with 12' posts require two midpoint braces and three diagonal braces. The two-post vertical shore midpoint brace should be constructed with 2x4 lumber.

Topic 6-4: Introduction to the Two-Post Vertical Shore (Class II)

Figure 6:37

## Two-Post Vertical Shore

Position the HEADER and SOLE PLATE across the floor and ceiling joists. Position the POSTS in line with the joists, but no greater than 4 feet apart.



DESIGN LOAD (Shore Height)	
4x4 POST	6x6 POST
16,000 lb for 8 ft	40,000 lb for 12 ft
10,000 lb for 10 ft	29,000 lb for 14 ft
7,000 lb for 12 ft	24,000 lb for 16 ft



Header may need to be larger for supporting badly cracked concrete (see Structures Spec)

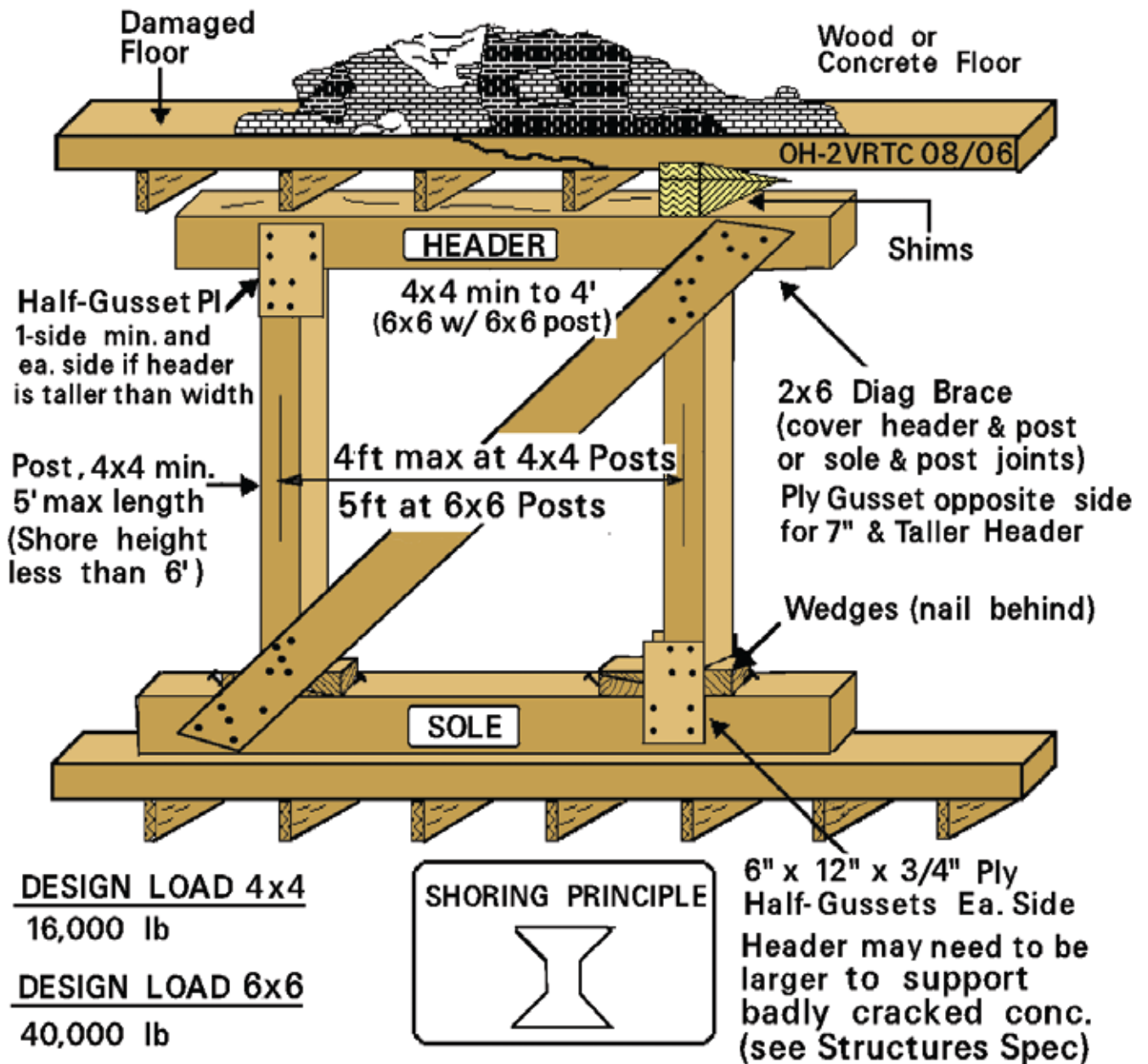
Max 4x4 Shore Height is 12 ft unless built as part of Laced Post

Topic 6-4: Introduction to the Two-Post Vertical Shore (Class II)

Figure 6:38

### Two-Post Vertical Shore for Limited Height Area

Position the HEADER and SOLE PLATE across the floor and ceiling joists. Position the POSTS in line with the joists, but no greater than 5 feet off-center. The header may slope 6" in 110 feet, which equals approximately 3 degrees.



**BUILT THE SAME AS ONE SIDE OF A HALF-HIGH LACED POST**



# RESCUE SYSTEMS 1

## Basic Rescue Skills



### Topic 6-4: Introduction to the Two-Post Vertical Shore (Class II)

#### **Two-Post Vertical Shore Assembly**

1. Measure and cut the proper length of the header and sole plate.
2. Measure the overall height to be shored; use the shortest length measure if area is uneven.
3. Deduct the thickness for the header, sole plate, and wedges.
4. Measure and cut the two vertical posts.
5. Nail gusset plates to one side of the header and posts to secure the two together.
6. Turn the shore over to the other side.
7. Measure, cut, and install the midpoint brace, if needed.
8. Measure, cut, and install the top diagonal brace to secure the header to the vertical posts.
9. Position shore and sole plate under the load; align the ends of the header and sole plate.
10. Ensure the shore is plumb.
11. Pressurize the posts with wedges.
12. Measure, cut, and install the bottom diagonal brace to secure the sole plate to the vertical posts.
13. Nail gusset plates and/or cleats on both sides of post joints not covered by a diagonal brace to secure all joint connections.
14. Evaluate shore and structure.



---

# RESCUE SYSTEMS 1

## Basic Rescue Skills

---



### Topic 6-4: Introduction to the Two-Post Vertical Shore (Class II)

---

## Topic 6-5: Introduction to the Horizontal Shore

**Scope:** This chapter serves as an introduction to the Horizontal Shore.

**Terminal Learning Objective (TLO):** At the end of this chapter, the student will be familiar with the skills and techniques required to construct horizontal shores.

**Enabling Learning Objectives (ELO):**

1. Describe the uses for horizontal shores.
2. Describe the components of horizontal shores.
3. Describe the assembly procedures for horizontal shores.
4. Describe the proper placement of shoring components.
5. Describe the evaluation and safety check process for horizontal shores.

A horizontal shoring system can be applied to weakened walls that are in close proximity to other walls. They may also be constructed between two exterior walls of buildings that are in close proximity to one another. These shores work well to support hallways and corridors.

### Components of the Horizontal Shore

**Wall Plates:** Plates that collect the weight being transferred laterally on one side, spread it to the horizontal struts, and distribute it to the wall plate on the opposite side. The wall plate should be as plumb and flush to the wall surfaces as possible. Backfill material can be used if needed between the wall plates and shored structure. The minimum size lumber that should be used is 4x4 material.

Similar to the vertical shore header, the ends of the wall plates should not extend more than 12" past the top and bottom struts. This clearance provides an area for the diagonal braces to attach to and maintain the maximum length requirement so failure of the strut due to the cantilever effect is minimized. The plates should be positioned directly in line with main structural elements.



Figure 6:39 Horizontal Shore

**Struts:** Components that support the weight being transferred laterally from one wall plate to the other wall plate. They should be perpendicular to and maintain full surface contact with the wall plates.

Usually two struts per shore are used. If the span between the top and bottom strut is greater than 4', a middle strut may be required. However, when more than two struts are used, full access of the opening becomes limited.

The capacity of each strut with 4x4 wall plates on 4-foot centers is approximately 6,000 pounds. This is based on the crushing effect of the wall plate and not due to the bending and breaking of the strut itself. The 4x4 struts used in these systems should not be longer than 8' due to the potential of sudden failure from the strut buckling unless diagonal and midpoint braces are attached.



# RESCUE SYSTEMS 1

## Basic Rescue Skills



### Topic 6-5: Introduction to the Horizontal Shore

**Wedges:** Inclined planes used to pressurize the shore or fill gaps between the shore and the structure. Wedges are used in pairs with the cut side of each wedge married against each other for better holding capability and for a better striking surface for the hammers when pressurizing.

**Gusset Plates:** 6"x12"x $\frac{3}{4}$ " plywood squares that secure the connections between the different parts of the shore such as the header and the horizontal posts. They are connected with 8d nails using a four-nail pattern. Gussets are used in joint areas that are **not** secured by the diagonal bracing.

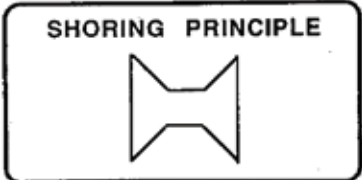
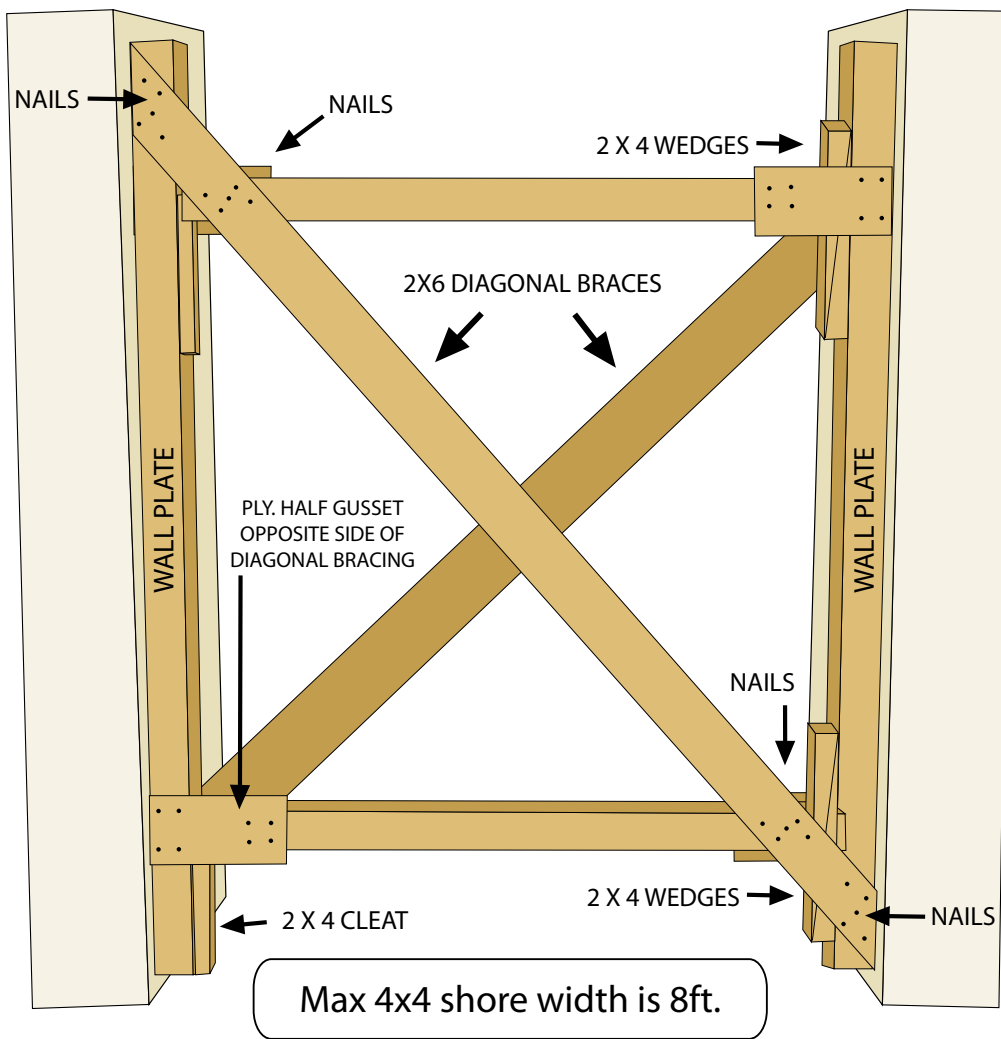
**Cleats:** Short pieces of lumber used to support or secure shoring component parts. 2x4 material in various lengths is usually used and secured with nails. Caution should be taken when nailing cleats due to the susceptibility of the lumber to split during the nailing process.

**Diagonal Bracing:** Braces that lock the entire shore together so the posts all work as one unit. The diagonal braces provide lateral stability and prevent the shore from failing like a collapsing parallelogram. Horizontal shore diagonal braces span the entire length of the shore and connect the top of the wall plate and strut joint on one side to the bottom of the wall plate and post joint on the other side of the shore forming an "X" configuration. The top and bottom of the diagonal braces should cover part of the wall plate and strut connection points or joints.

**Midpoint Brace:** Brace that resists the buckling effect and the tendency for long struts to bend and break when put under pressure. Horizontal shores with 4x4 struts greater than 8' long require midpoint braces on both sides of the shore. Horizontal shore midpoint braces can be constructed with 2x6 or twin 2x4 lumber.

**US&R SHORING OPERATIONS GUIDE  
CONSTRUCTING HORIZONTAL SHORING SYSTEMS**

**TWO POST HORIZONTAL SHORE**



**WALL PLATES & STRUTS SHOULD BE SAME WIDTH FOR DIAGONAL BRACES TO BE MORE EFFECTIVE**

Figure 6:40 Horizontal Shore





# RESCUE SYSTEMS 1

## Basic Rescue Skills

### Topic 6-5: Introduction to the Horizontal Shore



#### **Horizontal Shore Assembly**

1. Measure and cut proper length of wall plates.
2. Measure the overall width to be shored; use the shortest length measure if area is uneven.
3. Deduct the thickness of the wall plates and wedges.
4. Measure and cut the struts.
5. Measure and mark strut location on wall plates.
6. Attach cleats to aid in strut placement, if needed.
7. Position the shore and align the ends of the wall plates.
8. Install and pressurize the top strut.
9. Install and pressurize the bottom strut.
10. Install diagonal braces if posts are 4' or greater unless access or egress is required.
11. Install midpoint braces if posts are 8' or greater.
12. Nail gusset plates and/or cleats on both sides of the post joints not covered by a diagonal brace to
13. secure all joint connections.
14. Evaluate the shore and structure.

## Topic 6-6: Introduction to the Pre-Constructed Window and Door Shore

**Scope:** This chapter serves as an introduction to Window and Door Shores.

**Terminal Learning Objective (TLO):** At the end of this chapter, the student will be familiar with the skills and techniques required to construct window and door shores.

**Enabling Learning Objectives (ELO):**

1. Describe the uses for window and door shores.
2. Describe the components of window and door shores.
3. Describe the assembly procedures for window and door shores.
4. Describe the proper placement of shoring components.
5. Describe the evaluation and safety check process for window and door shores.

Window and door shores are used by rescuers to stabilize damaged windows, doorways, and other access ways within a weakened wall system. Anytime rescuers use an opening as a means of access and egress, they should shore the opening if it has been damaged or weakened from the collapse. Areas of forced entry through walls should also be shored to provide stability to the damaged wall and protection to rescuers who must enter the area.

The shore that is usually installed to protect openings can also be installed to protect the integrity of the wall. If the openings are not protected, the failure of the opening can lead to failure of the wall section.

Window and door shores are multidirectional shores that are pressurized in all directions, unlike most emergency shoring systems that are pressurized only in one direction. If load stresses are obviously exerted from one particular direction, the shore should be built to support the direction of failure. If the collapse is from above, the shore should be built similar to a vertical shore, and if the collapse is from the sides, the shore should be built like a horizontal shore.

Window and door shores can be assembled using one of two methods. The **Construct-in-Place Method** builds the shore by measuring, cutting, and installing individual shoring components one piece at a time in the opening.



Figure 6:41 Window and Door Shore



# RESCUE SYSTEMS 1

## Basic Rescue Skills



### Topic 6-6: Introduction to the Window and Door Shore

The **Preconstruction Method** builds the complete shore  $1\frac{1}{2}$ " less than the size of the opening in each direction. Plywood triangle gussets are nailed at each corner on both sides. After inserting the shore into the opening, wedges pressurize the bottom and one side. Additional wedges are added to the top as needed to increase surface contact. The primary advantages to this assembly method are allowing preconstruction away from the dangerous wall or opening and simplicity to build. Severely racked or otherwise deformed openings may prevent this method from being used.

When these shores are installed, consideration must be given not to compromise the opening for access and egress with shore components, especially if diagonal braces are used to reinforce the shore.

### Components of the Window and Door Shore

**Header:** Plate that collects the weight from above and transfers it to the vertical posts. The header plate should be level and perpendicular to the vertical posts. 4x4 lumber is the usual minimum size used in most rescue operations.

A rule of thumb is used to calculate the maximum span for the 4x4 in an opening. For every 1' of span, 1" of material is needed. So, if a 4x4 is used, a span of approximately 4' can be obtained without additional support. If a longer span is required, rescuers can increase the dimension of the header by adding additional vertical posts. These additional posts will impact the overall size of the opening.

**Sole Plate:** Plate that distributes the weight being transferred from above and spreads it over a wide area. The sole plate should maintain the same requirements as the header.

**Posts:** Posts that support the weight being collected by the header and transfer it to the sole plate. The posts should be perpendicular to and maintain full surface contact with both the header and sole plate.

**Wedges:** Inclined planes used to pressurize the shore or fill gaps between the shore and the structure. Wedges are used in pairs with the cut side of each wedge married against each other for better holding capability and for a better striking surface for the hammers when pressurizing. Deduct  $1\frac{1}{2}$ " for 2x4 wedges.

**Gusset Plates:** 12"x12"x17"x $\frac{3}{4}$ " plywood triangles that secure the connections between the different parts of the shore like the header and the vertical post. They are connected with 8d nails using a five-nail pattern. Gussets are used in joint areas that are **not** secured by the diagonal bracing.

**Cleats:** Short pieces of lumber used to support or secure shoring component parts. 2x4 material in various lengths is usually used and secured with nails. Caution should be taken when nailing cleats due to the susceptibility of the lumber to split during the nailing process.

**Diagonal Bracing:** Braces that lock the entire shore together so the posts work as one unit. The diagonal brace protects the shore from shifting and failing like a collapsing parallelogram and is installed when the opening is **not used** for access. The diagonal braces connect the top of one vertical post or wall plate on one side to the bottom of the vertical post or wall plate on the other side of the shore, forming an "X" configuration.

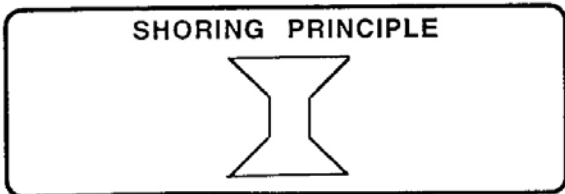
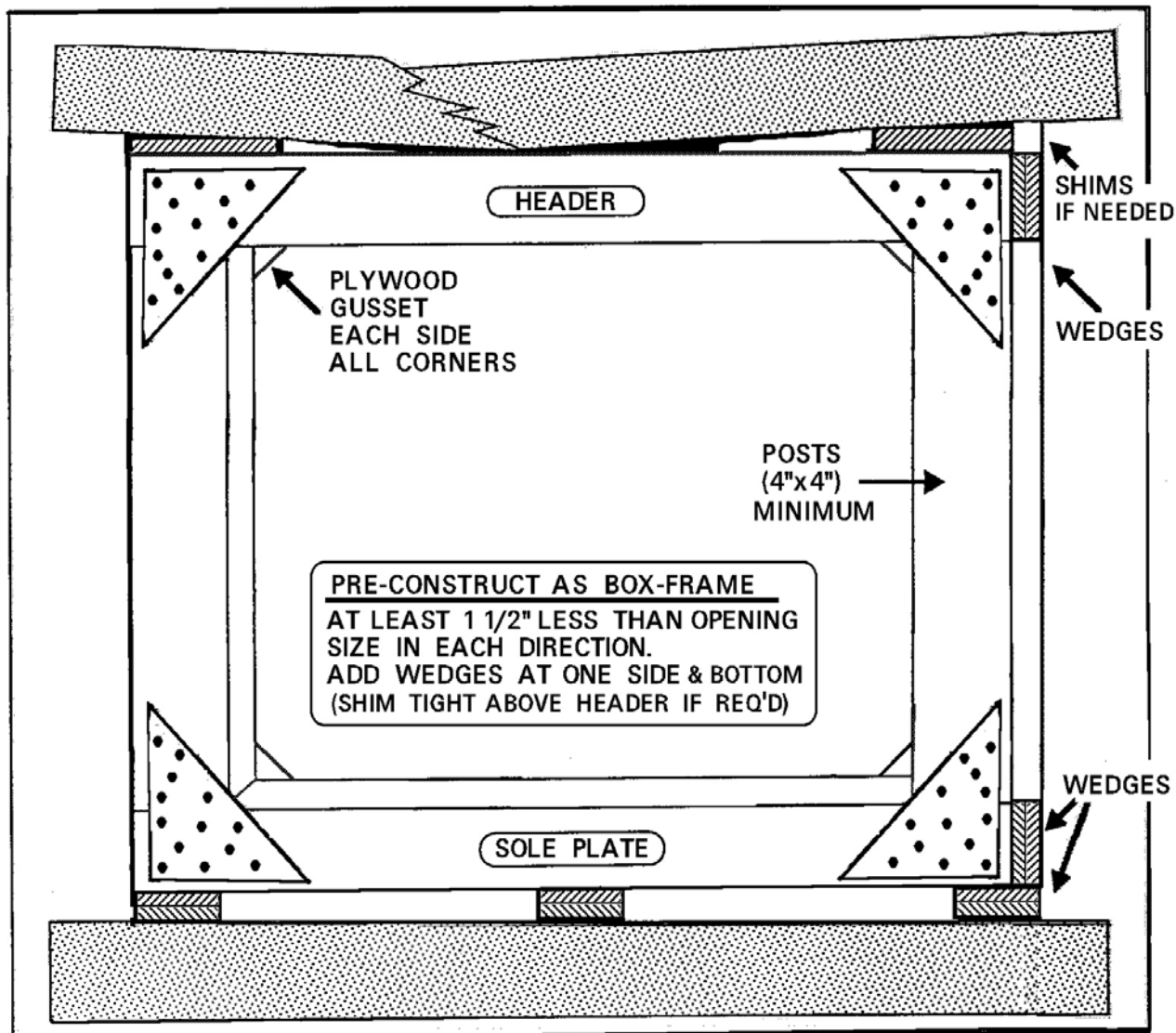
Preconstructed Window and Door Shore

## ALT • WINDOW & DOOR SHORE

O/H-11A  
8/05

PRE-CONSTRUCT, PLACE IN OPENING, AND TIGHTEN WEDGES

THE HEADER REQUIRES 1 in. OF THICKNESS FOR EVERY FOOT OF HORIZONTAL OPENING  
(Example: 3' opening = min. 4" X 4" Header)



HEADER, POSTS & SOLE PLATE MUST BE SAME WIDTH

Figure 6:42

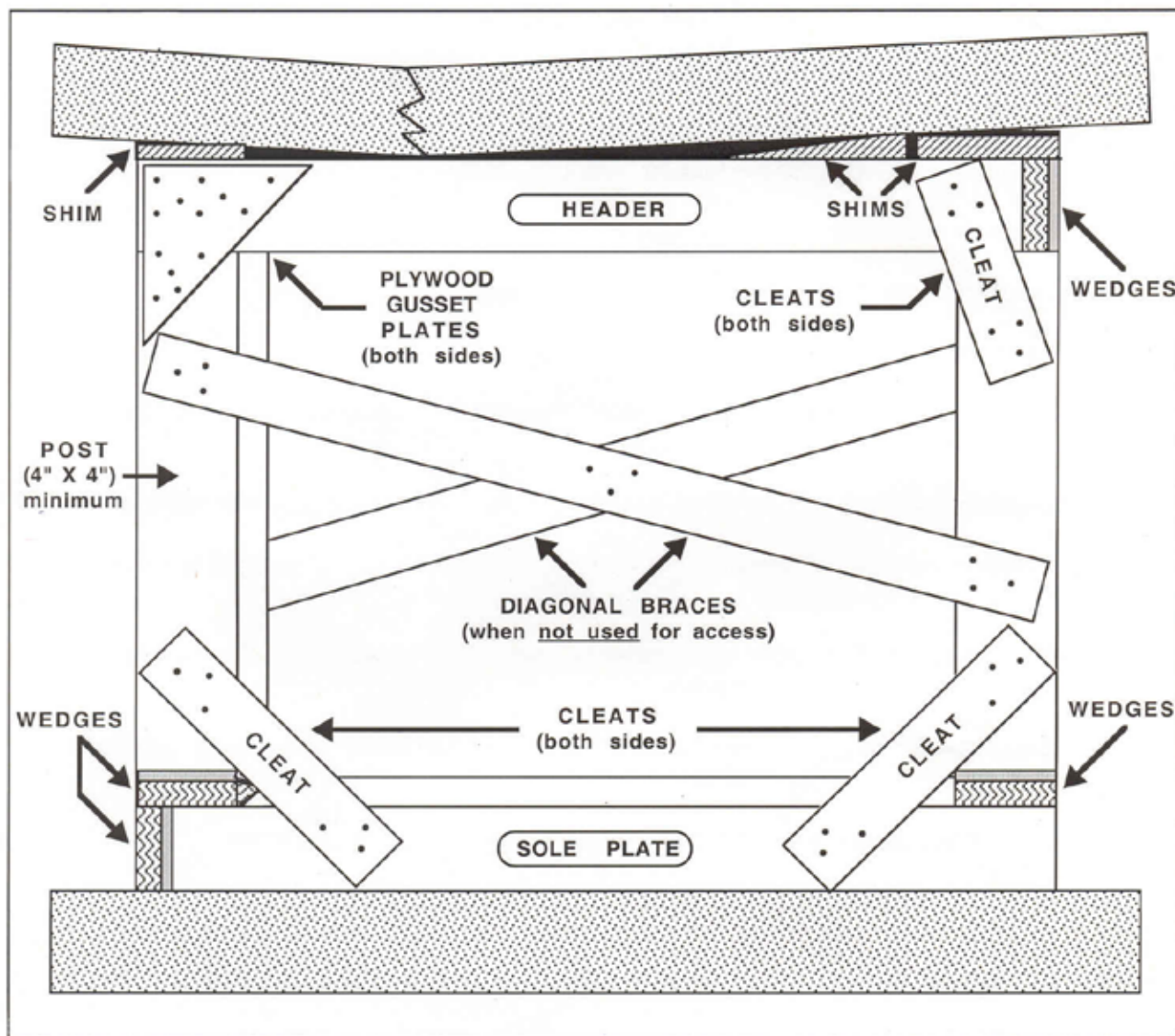
## Preconstructed Method

1. Measure the proper length of the header and sole plate using the shortest length measured if the opening is uneven.
2. Deduct 1½" from the length of the header and sole plate.
3. Cut the header and sole plate to desired length.
4. Measure the overall height to be shored using the shortest length measured if the opening is uneven.
5. Deduct the depth for the header and sole plate.
6. Deduct 1½" from the height to allow for pressurization with wedges.
7. Cut the vertical posts to desired length.
8. Lay out the cut components of the shore on the ground.
9. Place vertical posts between the header and sole plate.
10. Secure the top and bottom of the vertical posts to the header and sole plate using triangular gusset plates.
11. Turn the shore over to the other side.
12. Secure the top and bottom of the vertical posts to the header and sole plate using triangular gusset plates.
13. Install the shore into the window opening.
14. Pressurize the shore with 1½" wedges under the sole plate using two sets of wedges.
15. Pressurize the shore with 1½" wedges to the side of one vertical post using three sets of wedges.
16. Install diagonal braces if the opening is not used for access or egress.
17. Evaluate the shore and structure.

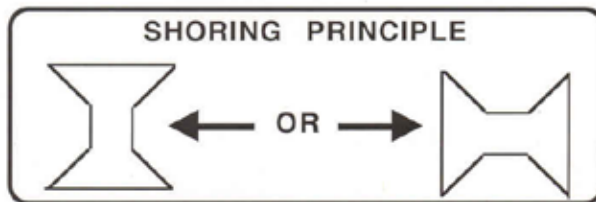


Figure 6:43

## Construct in Place Window and Door Shore



**CONSTRUCT  
IN-PLACE  
METHOD**



HEADER, POSTS &  
SOLE PLATE SHOULD  
BE SAME WIDTH FOR  
DIAGONAL BRACES TO  
BE MORE EFFECTIVE

Figure 6:44

## Window and Door Shore Assembly

### **Construct-in-Place Method**

1. Measure and cut the proper length of the header and sole plate, deducting 1½" for the wedges.
2. Measure the overall height to be shored using the shortest length measure if opening is uneven.
3. Deduct the thickness of the header, sole plate, and 1½" for the wedges.
4. Measure and cut the vertical posts.
5. Install the sole plate and pressurize the 2x4 wedges.
6. Install the header and pressurize the 1½" wedges. Install header and sole plate wedges in opposite corners.
7. Install one post under the header wedges to prevent movement and pressurize with 2x4 wedges.
8. Install the other post at the other end of the header and pressurize the wedges.
9. Attach triangular gusset plates to both sides of the corners without wedges to secure the post and header.
10. Attach cleats to both sides of the other corners to box in the wedges and secure the post, sole plate, and header joint.
11. Install wedges between the header and the opening, as needed, to increase surface contact.
12. Install diagonal braces from post to post if the opening is not used for access or egress.
13. Evaluate the shore and structure.



Figure 6:45



# RESCUE SYSTEMS 1

## Basic Rescue Skills



### Topic 6-6: Introduction to the Window and Door Shore

**When the load is from above, construct similar to a vertical shore.**  
**When the load is from the side, construct similar to a horizontal shore.**





---

# RESCUE SYSTEMS 1

## Basic Rescue Skills

---



### Topic 6-6: Introduction to the Window and Door Shore

---

## Topic 6-7: Introduction to the Sloped Surface Shore with Cribbing

**Scope:** This chapter serves as an introduction to the Sloped Surface Shore with Cribbing.

**Terminal Learning Objective (TLO):** At the end of this chapter, the student will be familiar with the skills and techniques for using cribbing in combination with a shoring system.

**Enabling Learning Objectives (ELO):**

1. Describe the need for shoring a sloped surface with cribbing.
2. Describe the components of a sloped surface shore with cribbing.
3. Describe the assembly procedures for cribbing a sloped surface.
4. Describe the evaluation and safety check process.

The use of cribbing as shoring is very advantageous and one of the most effective and simplest stabilization methods. It can be easily adjusted to proper height and applied to sloped surfaces. Cribbing can be diagonally braced to increase lateral support and it can be used to brace crossbeams that support a large area of a structure. Crib shoring is relatively wide and stable. It effectively transfers the collected loads over multiple shoring elements that are working together to hold the load.



Figure 6:46 Sloped Floor Shoring

The crib shoring system uses basic lumber materials that can be pre-cut and ready for immediate use, even in small confined areas. The process of making measurements, cutting, and nailing to install the shore can be eliminated, unlike the process of installing other shoring systems.

When loaded vertically, an advantage of crib shoring systems is that when they start to fail, they fail from crushing. This failure will be slow and noisy, which acts as a warning system for rescuers that the shoring system is overloaded. Although there are advantages to using cribbing, there are some disadvantages that rescuers need to consider. Cribbing uses a large amount of material and requires a fairly level base to build on.

Cribbing shores can be built in a box using two members per layer or in a cross-tie configuration using three members per layer for increased capacity and stability. The capacity of a two-member box crib using 4x4 lumber is 24,000 pounds and that of a three-member cross-tie crib using 4x4 lumber is 54,000 pounds.

## Topic 6-7: Introduction to the Sloped Surface Shore with Cribbing

To maximize crushing failure of cribbing, the tails of each layer should extend approximately its dimension past the layer of the cribbing below. When the crib bed is loaded to capacity, it will crush, creating saddles similar to Lincoln Logs, preventing pieces from squirting out. This method works only if the load remains relatively square to the ground. If the object is not square to the ground, the cribbing tails or ends will be loaded and cause a cantilever effect. The crib bed can become unstable and reduce its load-carrying capability.

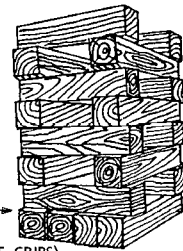
When cribbing to sloped surfaces, place the ends of the cribbing closest to the sloped load flush with the layer below to increase crib bed stability and reduce the cantilever effect.

When using cribbing shoring systems, lateral stability of the crib bed must be considered. Lateral stability will be dependent on the width-to-height ratio of the crib bed.

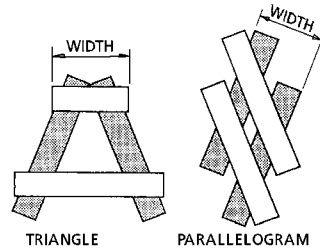
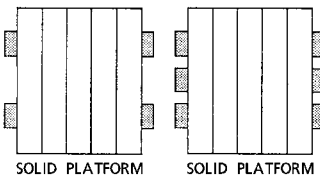
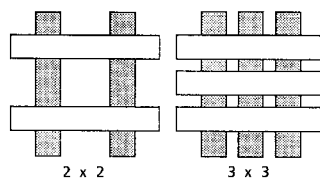
A rule of thumb is that you can build a crib bed three times as high as the width of the crib contact points. Example: If the width of the crib contact points is 3', then the crib bed can be built 9' high and still maintain stability **if built on level surfaces**. This width to height ratio is only a guideline for the maximum height of the crib bed. A reduced height must be considered if the load proves to be unstable.

When shoring **sloped surfaces** with cribbing, the maximum allowable height is 1½ times the crib contact points. The maximum angle at which cribbing can be used for sloped surfaces is 15° or 30 percent (3' elevation within a 10' distance). The potential for large slabs to slip off the crib bed increases when steeper surfaces are shored. A sloped crib has the potential to slip or fail laterally.

**CAPACITY BASED ON CROSSGRAIN BEARING**  
 (VARIES FROM 200 PSI TO 1000 PSI DEPENDING ON WOOD SPECIES  
 500 PSI IS USED HERE - EXAMPLE 500 x 3.5 x 3.5 x 4 = 24,000)  
**FOR 2 MEMBER x 2 MEMBER LAYOUT**  
 4 x 4 CRIB CAPACITY = 24,000 LBS (12 TONS)  
 6 x 6 CRIB CAPACITY = 60,000 LBS (30 TONS)  
**FOR 3 MEMBER x 3 MEMBER CRIB, CAPACITY IS 9/4 AS MUCH**  
 500 x 3.5" x 3.5" x 9 = 55,000, 500 x 5.5" x 5.5" x 9 = 136,000



- BOTTOM LAYER SHOULD BE SOLID TO SPREAD THE LOAD ESPECIALLY ON SOIL OR ASPHALT PAVING
- LIMIT HEIGHT TO 3 TIMES WIDTH (SHORTEST WIDTH FOR NON-SQUARE CRIBS)
- OVERLAP CORNERS BY 4 INCHES TO ASSURE SLOW CRUSH TYPE FAILURE



BOTH ARE NOT VERY STABLE, KEEP HEIGHT TO WIDTH WITHIN 1 TO 1

### SHOR-4r 9/98

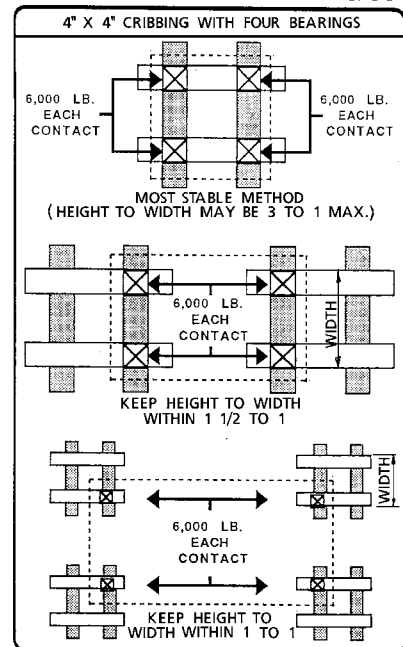


Figure 6:47 Window and Door Shore

## **Components of the Sloped Surface Crib Bed**

**Cribbing:** Lumber size and minimum length:

- 2x4x18"
- 2x4x2'
- 4x4x18"
- 4x4x2'
- 6x6x2'

Many departments use 18"-long cribbing. This size is convenient for storage and allows more pieces per 8' lumber stock. Shoring operations on sloped surfaces are limited and less stable due to a shorter overall shoring height that can be reached. A maximum of 8' between cribbing systems under a sloped surface is allowed under most conditions. If the sloped surface is severely damaged or is heavily weighted, the maximum space allowed between crib beds should be reduced to 4' or less.

**Wedges:** Usual size:

- 2x4x12"
- 4x4x18"

Wedges are used primarily as single pieces to fill void spaces and to change the angle of cribbing surface contact. The crib bed is built flat and level, with the angle change occurring at the top of the bed next to the sloped surface.

**Header:** Used to collect the weight from the structural element shored and to spread it throughout multiple crib beds in the shoring system. The minimum lumber size is a 4x4.



Figure 6:48

**No body parts** are placed under unsupported loads during the assembly of the sloped surface crib bed. **Remember**—to lift an inch, crib an inch.

Prior to assembly or installation, rescuers must consider the access and egress pathways. A crib bed can take up significant access space that may get in the way of rescue operations and personnel movement. Well-placed shores will ensure maximum level of safety and access possible in the collapsed structure.

When placing cribs or wedges, no more than two parallel layers of the same material should be stacked on top of each other. Stacking more than two parallel layers in the same direction greatly reduces the stability of the shore.

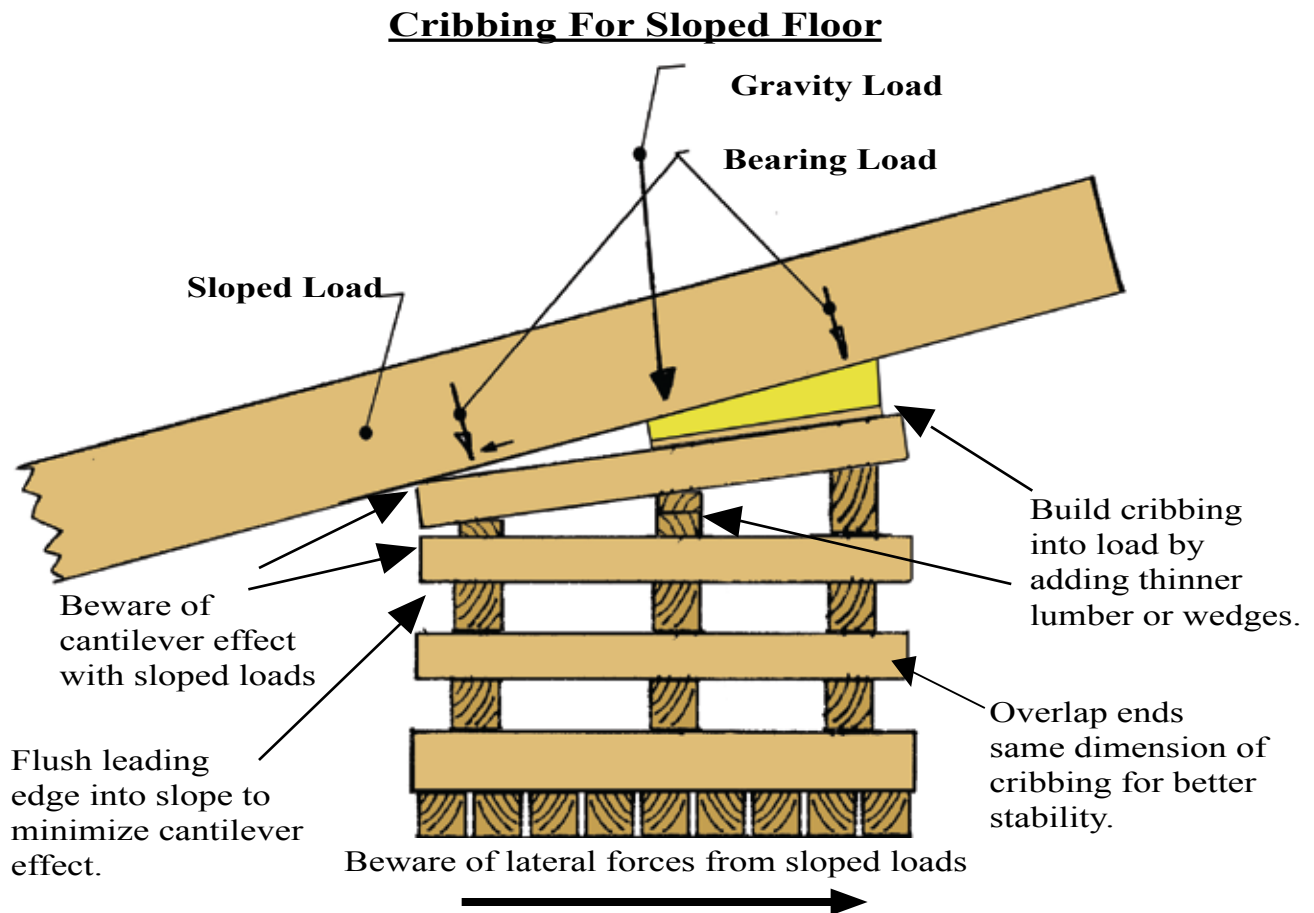


Figure 6:49 Sloped Surface Shore with Cribbing



# RESCUE SYSTEMS 1

## Basic Rescue Skills



### Topic 6-7: Introduction to the Sloped Surface Shore with Cribbing

#### **Sloped Surface Crib Bed**

1. Place first layer of cribs.
  - Place ends of crib perpendicular to the object.
  - On soft surfaces, use a solid layer of cribbing parallel to the object.
  - Lay cribs level to the ground.
2. Place second layer of cribs.
  - Lay it perpendicular to the first layer.
  - Maintain a 3½" overlap from ends of the first layer.
  - When cribbing to sloped surfaces, place the ends of the cribbing closest to the load in line with the layer below. This increases crib bed stability and reduces the cantilever effect.
  - Use another crib to push the crib members into position under the unsupported sloped surface.
3. Place additional layers. Continue alternating the direction on each layer until the crib bed components are in near contact with the object to be shored.
4. Change the angle.
  - Use the last two crib layers to change the angle of the shore to make contact with the shored surface.
  - Thinner cribbing material or wedges can be used under the sloped surface area to change the angle of the crib bed.
5. Fill void spaces.
  - Fill all void spaces to ensure full surface contact.
  - Gently tap the wedges to snug up the shore.
6. Evaluate the shore and structure.



---

# RESCUE SYSTEMS 1

## Basic Rescue Skills

---



Topic 6-7: Introduction to the Sloped Surface Shore with Cribbing

---

## Topic 6-8: Introduction to the Split Sole Raker Shore System

**Scope:** This chapter serves as an introduction to the Raker Shore.

**Terminal Learning Objective (TLO):** At the end of this chapter, the student will be able to Construct a split shore

**Enabling Learning Objectives (ELO):**

1. Describe the uses for the split sole raker shore.
2. Describe the components of a raker shore system.
3. Describe the assembly procedure for a raker shore system.
4. Describe the proper placement of shoring components.
5. Describe the evaluation and safety check process for a raker shore system.

Raker shores are used to support leaning or unstable walls and columns. The two types of raker shores built are the solid sole raker shore and the split sole raker shore. The Rescue Systems 1 course will focus on the split sole raker. These 4x4 raker shores are impractical to use on high walls (above two stories) due to the tremendous weights involved and length of available lumber. In the case of high, unstable walls, it is best to avoid the area. Unstable sections may be carefully removed, have engineered shores installed, or have commercial shore systems installed.



Figure 6:50

The raker shore pushing against the wall exerts a vertical force that at times tends

to make the shore assembly creep up the wall. The horizontal force being applied by the wall in an outward direction is resisted by the shore being secured by anchors at the base of the shore.

The split sole raker shore can be constructed at 45° to 60° angles. They are always installed in a series of at least two rakers with a maximum separation of 8' and are braced together for additional stability.

Placement of the raker tip is to be within 2' above or below floor or roof level on the outside of the compromised wall. This placement is commonly referred to as the **Insertion Point**.

- Rakers are used when shoring over debris on even or uneven ground.
- They can be used in urban environments where concrete or asphalt commonly covers the ground.
- Stability is increased when rakers are attached to wall or column.



- ❑ The maximum load rating is 2,500 pounds per raker.

## Components of the Split Sole Raker Shore

**Wall Plate:** Plate that collects the weight being transferred horizontally and spreads it throughout the shoring system. The minimum lumber size that should be used is a 4x4. The length is measured from the insertion point to ground level, plus the length of the top cleat. Backing can be made of 2" lumber or ¾" plywood to widen surface contact, if needed. If being constructed over debris, the wall plate will need to be shortened to the depth of the debris pile.

**Top Cleat:** A short piece of 2x4 lumber that is nailed to the top of the wall plate to keep the raker from riding up the wall plate. The tip of the raker will be in full contact with the bottom of the top cleat when erected. A 2-foot cleat with fourteen 16d nails is used for 45° rakers and a 2½-foot cleat with twenty 16d nails is used for 60° rakers.

**Trough Base:** Base that is used on a split raker shore, the Trough Base distributes the weight being transferred laterally and distributes it to the ground. These are mostly used in urban environments where concrete and asphalt commonly cover the ground. The Trough Base is pressurized by wedges contacting a solid object or minimum 4" x 4" deadman secured with steel pickets to prevent the shore from sliding backwards. Use two 1" pickets in concrete or asphalt, and four pickets in soil.

**U-Channel Sole Plate:** Plate that is used on a split sole raker shore built on soft ground. The U-channel sole plate captures the weight being transferred laterally and distributes it to the ground. These are mostly used in suburban and rural environments where open ground is available.

**Raker:** The main member of the shore. It supports the weight being collected by the wall plate and transfers it to the trough or U-channel. The minimum lumber size that should be used is a 4x4. The width of the raker should be the same as the wall plate and short sole plate for a more secure attachment of gusset plates, cleats, or braces.

- ❑ On a split sole raker, the length is measured from the insertion point on the wall plate to the contact point on the short sole plate or the contact point on the U-channel.
- ❑ The length of the raker is best determined by using the factor method.
- ❑ If using a U-channel for distribution, add 12" to the length of the raker.



Figure 6:51

**Wedges:** Inclined planes that are used to pressurize the shore or fill gaps between the shore and the structure. Wedges are used in pairs with the cut side of each wedge married against each other for better holding capability and for a better striking surface for the hammers when pressurizing.

**Gusset Plates:** 12"x12"x $\frac{3}{4}$ " plywood squares or triangles that secure the connections between the different parts of the shore such as the wall plate and raker. They are connected with nails using a five-nail pattern. Gusset plates should be kept at least a  $\frac{1}{4}$ " away from the outside edge of the framing members in order to prevent pressurizing them. On the raker shore, they should be placed on both sides of the joints.

**Bottom Braces:** Braces that connect the wall plate to the raker. One end of the bottom brace is nailed to the bottom of the wall plate. The other end is nailed as close to the bottom end of the raker as possible. The minimum size lumber to be used is one 2x6 or two 2x4s on both sides of the raker.

**Midpoint Braces:** Braces that are used to resist the "buckling" effect. These are required when the 4x4 raker is greater than 11' in length or the 6x6 raker is greater than 16' in length. They are attached to both sides near the midpoint of the raker and connected to the wall plate just above the bottom braces. The minimum size lumber to be used is one 2x6 or two 2x4s.

**Horizontal Braces:** Braces that connect the raker shores together near the top and bottom of the raker to provide additional stability. Horizontal braces are also placed at the middle of the raker if midpoint braces are used. The minimum size lumber to be used is one 2x6 or two 2x4s.

**"X" and "V" Braces:** Braces that provide additional stability and resist lateral deflection of the shores. They are used at the end of each raker shore system and no farther than 40' apart. They are attached between the top and bottom of two raker shores when using an "X." If a midpoint brace is used, an "X" will be placed above and below the midpoint brace. The minimum size lumber to be used is one 2x6 or two 2x4s.

## CLEATS, CUTS & ANCHORS

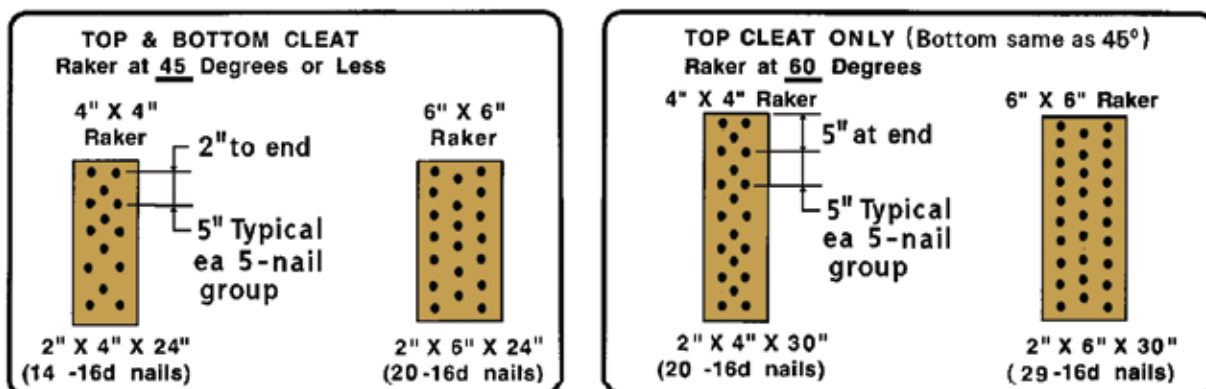


Figure 6:52

**Ledger Board:** A piece of 2x4 lumber that is nailed to the wall above the wall plate. The ledger board prevents the raker shore from riding up the wall. The minimum size lumber to be used is one 2x6 or two 2x4s, 36" in length. Option: A 36"-wide piece of plywood can be nailed to the backside of the wall plate and nailed to the wall studs.

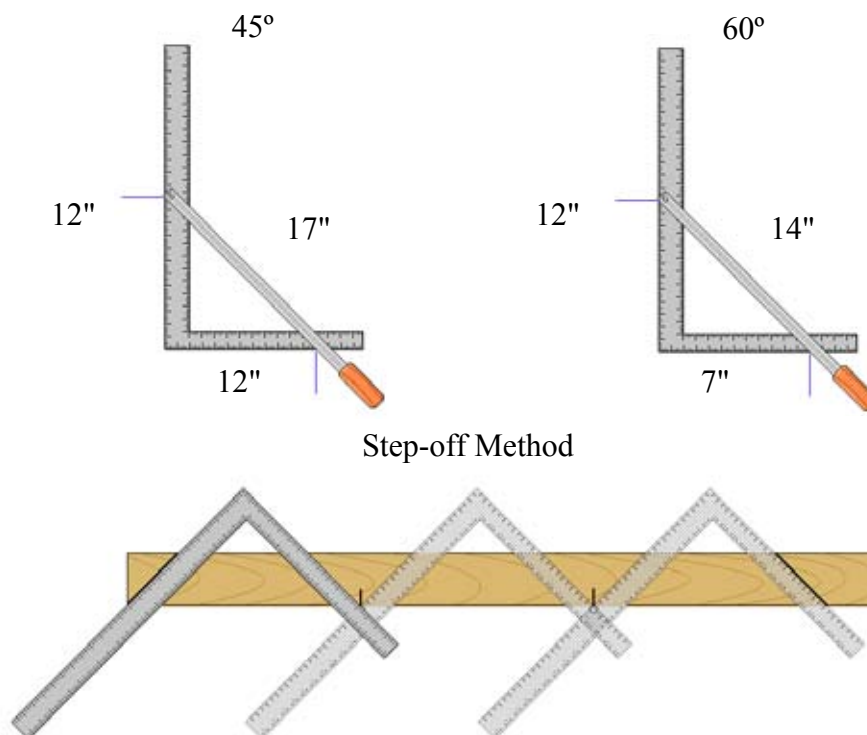
**Anchors for Raker Systems:** Must be deadman with pickets, and an optional ledger board nailed to studs above the wall plate, or plywood that is nailed to the back of the wall plate, then nailed into the wall studs.

## Measuring Tools to Determine Raker Length and Angle

**Tape Measure:** The most common tool used to determine lumber length is a tape measure with a 1"-wide steel tape with power return for ease of use and simple-to-read measurements. During construction of emergency shoring systems, a good practice is to measure and report all measurements in inches. This will reduce the chance of not understanding a measurement being reported via radio or in person by someone other than the person doing the measuring. An example of this would be requesting a 4x4 with a length of 9'6". If the measurement is reported over the radio as "one 4 by 4 by 9 6" the lumber could be cut at 96" or 114" (9'6"), which is the actual size being requested. It is easier to understand 114" than 9'6". The tape measure can also be used to determine the length of a raker.

**Framing Square:** A steel framing square can also be used to determine the length and angle of a raker. The Factor Method and the Step-off Method are just two ways in which to determine the proper length and angle of a raker. It is also useful in determining other angles and ensuring shoring components are square 90° angles.

Figure 6:53  
Factor Method



**Speed Square:** The speed square resembles a triangle and can be made of metal or plastic. It is used to ensure that shoring components are square at 90° angles. It is also useful to determine the angle of a raker.

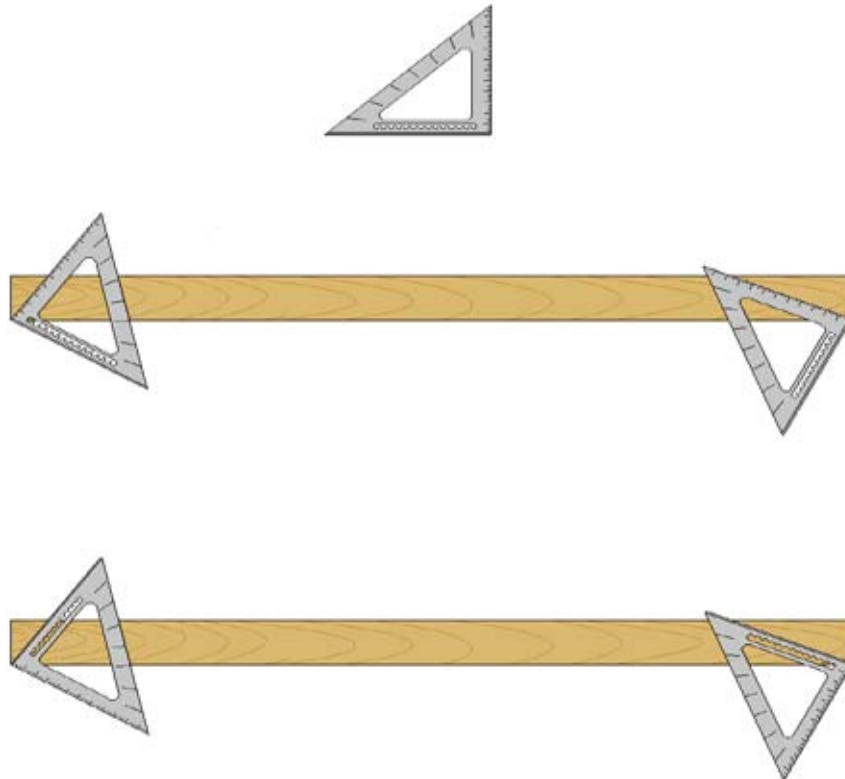


Figure 6:54

## How to Determine Length of Raker and Wall Plate

Length of Raker: Insertion Point in feet, times the factor, equals length of raker in inches.

Factors: 45° Raker = 17

60° Raker = 14

Length of Wall Plate: Insertion Point in feet, plus the cleat length, equals length of wall plate.

Factors: 45° Raker = 24" cleat

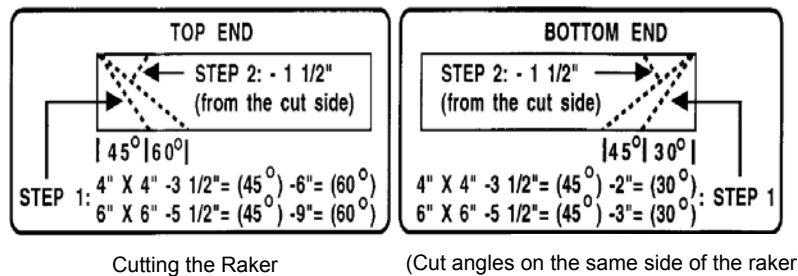
60° Raker = 30" cleat

## 45° and 60° Raker Angles

The raker is the most important component of the raker shore. It supports the weight being collected by the wall plate and transfers it to the trough base or U-channel base.

Figure 6:55

### HOW TO CUT THE TOP & BOTTOM ENDS OF THE RAKER



## Cutting a 45° Raker (Tape Measure Method)

1. Place a 4x4 into the 3 1/2" space of the cutting table and slide to edge of table.
2. Place a mark 3 1/2" back from the end of the lumber.
3. Draw a diagonal line from the end of the 4"x4" upper corner to the 3.5" mark on the outside edge of the lumber.
4. Cut this 45° line with a saw.
5. Place tape measure on raker tip with hook flush against the cut.
6. Move tape measure until 1 1/2" is on outside edge of lumber 90° to cut (backcut line).
7. Draw a line along the tape measure edge.
8. Cut this line.
9. Determine length of the raker by multiplying a factor of 17 times the height in feet to the insertion point. Example: 10-foot insertion point times 17 equals a 170" raker.
10. Using tape measure, hook tape on raker tip and measure length of raker desired.
11. Repeat points 2 to 8 for the other end of the raker.

NOTE: Add 12" to the length of the raker if a U-channel is used for the sole plate. Keep the bottom end of the raker at 90°.

NOTE: Always cut top and bottom angles on the same side of the lumber.

## Cutting a 60° Raker (Tape Measure Method)

1. Place a 4x4 into the 3 1/2" space on the cutting table and slide to edge of table.
2. Place a mark 6" back from the end of the lumber.
3. Draw a diagonal line from the end of the 4x4 upper corner to the 6" mark on the outside edge of the lumber.
4. Cut the 60° line with a saw.
5. Place the tape measure on the raker tip with the hook flush against the cut.
6. Move the tape measure until 1 1/2" is on the outside edge of the lumber 90° to cut.



# RESCUE SYSTEMS 1

## Basic Rescue Skills



### Topic 6-8: Introduction to the Split Sole Raker Shore System

7. Draw a line along the tape measure's edge.
8. Cut this line.
9. To determine the length of the raker, multiply factor of 14 times the height in feet to insertion point. Example: 10' insertion point x 14 = 140" raker.
10. Using a tape measure, hook the tape on the raker tip and measure the length of desired raker and mark.
11. Place a mark 2" back from this end of the marker.
12. Draw a diagonal line from the end of the 4x4 upper corner to the 2" mark on the outside edge of the lumber.
13. Cut this 30° line with a saw.
14. Place the tape measure on the raker tip with the hook flush against the cut.
15. Move the tape measure until 1½" is on the outside edge of the lumber 90° to cut.
16. Draw a line along the tape measure's edge.
17. Cut this line.

NOTE: Always cut top and bottom angles on the same side of the raker.

### **Cutting a 60° Raker (Speed Square Method)**

1. Place a 4x4 into the 3½" space on the cutting table and slide to top edge.
2. Place a speed square on the 4x4 with the guide edge against the lumber.
3. Slide the speed square to the end of the lumber.
4. To determine the 60° angle, place the pivot point in a fixed position at the end of the lumber and rotate the speed square away from the lumber until the 60° mark aligns with outside edge of the lumber.
5. Draw the angle on the ruler side of the speed square.
6. Cut this line.
7. Place the guide edge of the speed square on the 60° angle just cut.
8. Slide the speed square on the angle just cut until 1½" is measured on the ruler side, across the angle of the lumber (backcut line).
9. Draw a line on the ruler side of the speed square.
10. Cut this line.
11. Determine the length of the raker multiplying a factor of 14 times the height in feet to the insertion point.
12. Using a tape measure, hook the tape on the raker tip and measure the length of the desired raker.
13. Cut to measured length.
14. Place the speed square on the raker with the guide edge against the lumber.
15. Slide the speed square to the other end of the lumber.
16. To determine the 30° angle, place the pivot point in a fixed position at the end of the lumber and rotate the speed square away from the lumber until the 30° mark aligns with outside edge of the lumber.



# RESCUE SYSTEMS 1

## Basic Rescue Skills



### Topic 6-8: Introduction to the Split Sole Raker Shore System

17. Draw the angle on the ruler side of the speed square.
18. Cut this line.
19. Place the guide edge of the speed square on the 30° angle just cut.
20. Slide the speed square on the angle just cut until 1½" is measured on the ruler side, across the angle of the lumber (backcut line).
21. Draw a line on the ruler side of the speed square.
22. Cut this line.

NOTE: If a U-channel is to be used at the bottom end of the raker, keep the bottom end of the raker at a 90° angle. Add 12" to the length of the raker.

NOTE: Always cut top and bottom angles on the same side of the raker.

### **Cutting a 45° Raker (Speed Square Method)**

1. Place a 4" x 4" into the 3 1/2" space and slide to top edge.
2. Place a speed square on the 4" x 4" with the guide edge against the lumber.
3. Slide the speed square to the end of the lumber.
4. For a 45° angle, slide the fixed 45° angle of the speed square to the end of the lumber.
5. Draw a line along this angle of the speed square.
6. Slide the speed square on the angle, just cut until 1 1/2" is measured on the ruler side, across the angle of the lumber (backcut line).
7. Draw a line on the ruler side of the speed square.
8. Cut this line.
9. Determine the length of the raker by multiplying a factor of 17 times the height in feet to the insertion point.
10. Using a tape measure, hook the tape on the end of the raker tip and measure the length of the desired raker.
11. Cut to measured length.
12. Place the speed square on the raker with the guide edge against the lumber.
13. Repeat points 3 - 6 for the other end of the raker

NOTE: Always cut top and bottom angles on the same side of the raker.

### **Split Sole Raker Shore Assembly (U-Channel Method)**

1. Measure the height from the ground to the desired insertion point (in feet).
2. The wall plate length is determined by the insertion point (in feet) plus cleat length.
3. Cut the wall plate at the desired length. If the split sole raker is being constructed over debris, the wall plate will need to be shortened the height of the debris pile.
4. Construct U-channel gusset plates by nailing 12"x12" gusset plates to each side of an 18" 4x4.
5. Gather and lay out the components to preassemble the raker shore.
6. Nail the components together.
7. Attach the cleat to the top of the wall plate.



# RESCUE SYSTEMS 1

## Basic Rescue Skills



### Topic 6-8: Introduction to the Split Sole Raker Shore System

8. Align the raker to the wall plate.
9. Attach a gusset plate to the raker and wall plate connection on one side.
10. Measure the bottom brace length from the bottom of the wall plate to 12" past the raker.
11. Cut to the desired length.
12. Nail one end of the bottom brace a minimum of 12" up from the bottom of the wall plate.
13. Nail the other end as close to the bottom of the end of the raker as possible, with a single nail.
14. Place the raker shore against the wall.
15. Pull the nail from the bottom brace/raker connection point.
16. Adjust the raker and wall plate to the wall.
17. Dig a hole in the ground at the proper angle where the raker makes contact with the ground.
18. Place the U-channel at the bottom end of the raker, keeping the U-channel square to the raker.
19. Backfill the hole with soil or wedges if necessary.
20. Place 4x4 wedges between the end of the raker and the U-channel.
21. Attach a ledger board to the wall at the top of the wall plate.
22. Pressurize the raker with the wedges between the bottom end of the raker and the U-channel.
23. Renail the bottom brace to the raker.
24. Attach the second gusset plate to the top of the raker.
25. Complete all nailing patterns.
26. Measure and attach midpoint braces if needed.
27. Measure and attach horizontal braces.
28. Measure and attach "X" or "V" braces.
29. Attach the wall plates to the walls, if possible.
30. Evaluate the shoring system.

### **Split Sole Raker Shore Assembly (Trough Base Method)**

1. Measure the height from the ground to the desired insertion point (in feet).
2. The raker length (in inches) is determined by the insertion point (in feet) multiplied by the factor.
3. The wall plate length is determined by the insertion point (in feet) plus the top cleat length.
4. Cut the wall plate at the desired length. If the split sole raker is being constructed over debris, the wall plate will need to be shortened the height of the debris pile.
5. Measure and cut the Trough Base components.
6. Nail the components together.
7. Gather and lay out to pre-assemble raker shore.
8. Attach the cleat to the top of wall plate.
9. Align the raker to the all plate.
10. Attach a gusset plate to the raker and wall plate connection on one side.





# RESCUE SYSTEMS 1

## Basic Rescue Skills



### Topic 6-8: Introduction to the Split Sole Raker Shore System

11. Measure the bottom brace length from the bottom of the wall plate to 12" past the raker.
12. Cut to the desired length.
13. Nail one end of the bottom brace a minimum of 12" from the bottom of the wall plate.
14. Nail the other end as close to the bottom of the end of the raker as possible, with a single nail.
15. Place the raker shore against the wall with the bottom end of the raker on the Trough Base.
16. Pull the nail from bottom brace/raker connection point.
17. Adjust the raker and wall plate to the wall.
18. Anchor the Trough Base.
19. Attach a ledger board to the wall at the top of the wall plate. This may be done after the raker is assembled and anchored.
20. Pressurize the raker with wedges between the Trough Base and a picketed deadman or curb.
21. Renail the bottom brace to the raker.
22. Attach the second bottom brace to the raker.
23. Complete all nailing patterns.
24. Measure and attach midpoint braces if needed.
25. Measure and attach horizontal braces.
26. Measure and attach "X" or "V" braces.
27. Attach second gusset plate to top of raker.
28. Evaluate the shoring system.

## Topic 6-9: Introduction to the Cutting Station

**Scope:** This chapter serves as an introduction to the Cutting Station.

**Terminal Learning Objective (TLO):** At the end of this chapter, the student will be able to construct and safely operate a cutting station.

**Enabling Learning Objectives (ELO):**

1. Describe the uses for the cutting station.
2. Describe the design and components of the cutting station.
3. Describe the different applications for the cutting station.

### Cutting Station Setup

The cutting station is central to shoring operations and is constructed with available materials to provide a template or jig for the preparation of shoring materials. It should be located in a secure, safe area, close to the shoring objective and near materials supply.

The cutting station's advantages are that it uses fewer personnel to achieve goals and speeds ability to produce shoring components.

### Improvised Cutting Table

An improvised cutting table is assembled with cribbing or available building materials that are stacked so cuts can be made off the ground.

The cribbing should be secured with toenails and guides can be mounted to the top piece of cribbing to hold the lumber being cut.

### Components of the Cutting Table

**Top:** Provides a flat surface and support for marking, calculations, and cutting materials. Minimum size of the top should be 4'x4'x $\frac{3}{4}$ " plywood.

**Guides:** Provide template and jig for lumber to be cut in varying lengths and dimensions. They are premarked with measurements to reduce the time used to measure and mark shoring materials. Minimum lumber size is 2x4 spaced 1 $\frac{1}{2}$ ", 3 $\frac{1}{2}$ ", and 5 $\frac{1}{2}$ " apart. Be sure to allow an extra  $\frac{1}{4}$ " for irregular or wet lumber.

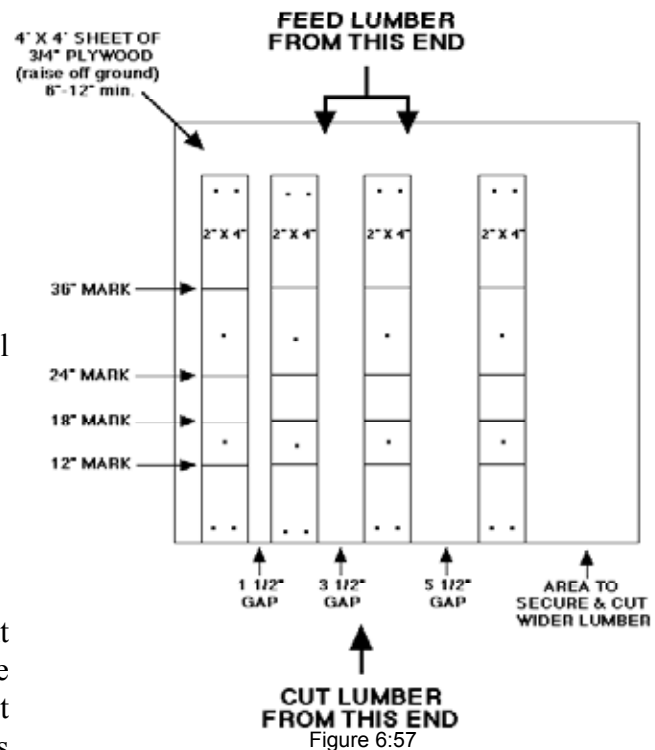
**Cribbing:** Provides support for the top and maintains required 6" minimum height. Cribbing is attached perpendicular to the guides under the plywood top. Legs may be added to bring the cutting table to a comfortable height.



Figure 6:56 Cutting Table

## Cutting Station Assembly

1. Measure and cut top to proper size.
2. Measure and cut guides to proper length.
3. Gather the correct amount of cribbing and materials.
4. Lay out cribbing on a flat surface within a 4'x4' area.
5. Place top on cribbing and nail into place. Add legs if desired.
6. Place guides on top at proper spacing and nail through guides and plywood into cribbing base with 16d nails.
7. Mark guides at 12", 18", 24", and every foot thereafter.



## Cleats, Wedges, and Gusset Plates

Cleats provide support or secure shoring component connections. Wedges provide the essential surface contact and the ability to adjust our shores. Gusset plates provide strong connections at component joints and shoring system stability.

### Cutting a Cleat

1. Place 2x4 into 3 1/2" slot and slide to end of table.
2. Mark length desired using the premarking on the runners.
3. Cut to length with handsaw or chainsaw.

### Cutting a Set of Wedges

1. Place 2x4 into 1 1/2" slot and slide to the end of the table.
2. Mark 12" length using the premarking on the runners.
3. Mark a diagonal line with a straight edge from one side of 12" line to the opposite side at the end of the 2x4.
4. Align the saw bar with the diagonal line pointing toward the cutting table and cut lumber.
5. Cut remaining half off at the 12" line.
6. Repeat process for 4x4 using 3 1/2" slot and 18" length.

### Cutting a Gusset Plate

1. Place a full 4'x8'x3/4" sheet of plywood on cutting station table.
2. Mark into 6"x12" and 12"x12" squares using a chalk line or straight edge and measuring tape.



# RESCUE SYSTEMS 1

## Basic Rescue Skills



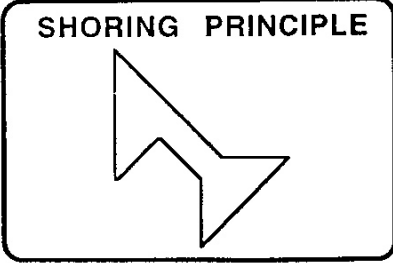
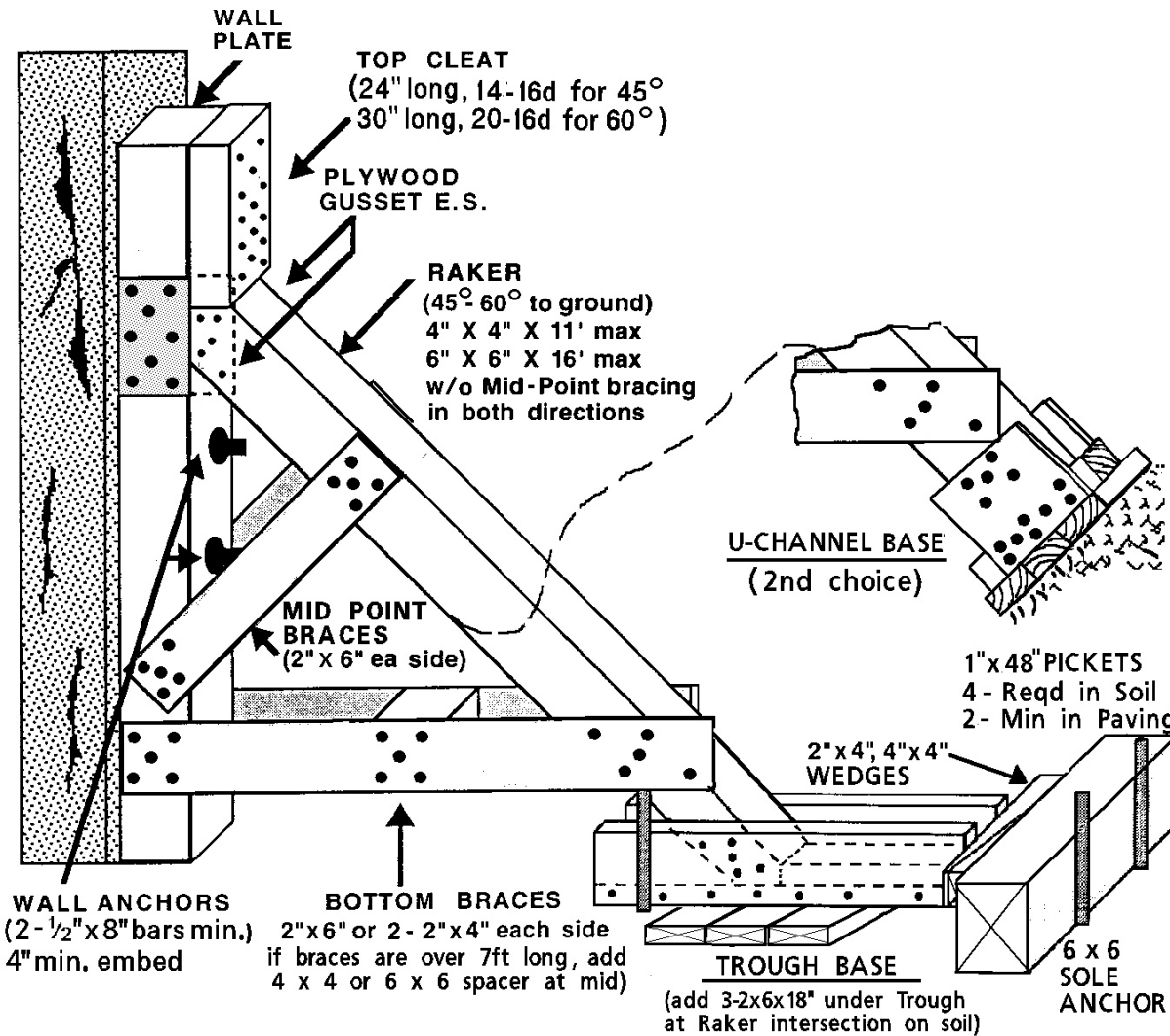
### Topic 6-9: Introduction to the Cutting Station

3. Cut with chainsaw along 8' length lines from end to end.
4. Stack 12"x8' lengths of plywood on top of each other with all edges aligned and marked piece on top.
5. Cut on 6" or 12" lines provided.
6. For a triangle gusset, mark a single 12"x12"x $\frac{3}{4}$ " gusset plate diagonally from corner to corner with a straight edge or chalk line.
7. Cut on diagonal line with chainsaw, creating two 12"x12"x17" gusset plates.

## RAKER SHORE

O/H-14-08  
11/08

### SPLIT SOLE METHOD



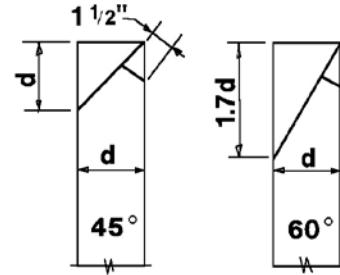
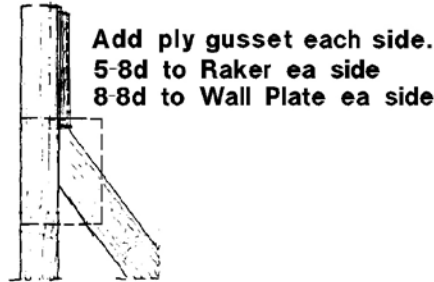
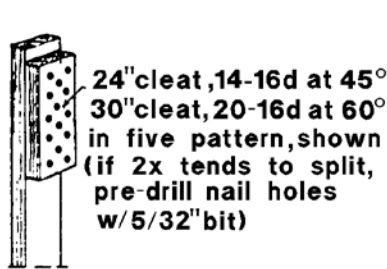
WALL PLATE & RAKER SHOULD BE SAME WIDTH FOR BRACES TO BE MORE EFFECTIVE

**NOTE:**  
U-CHANNEL REQUIRES DIGGING NEAR THE WALL, WHICH MAY BE DANGEROUS SEE FOLLOWING PAGES FOR DETAILS OF BASES

Figure 6:58

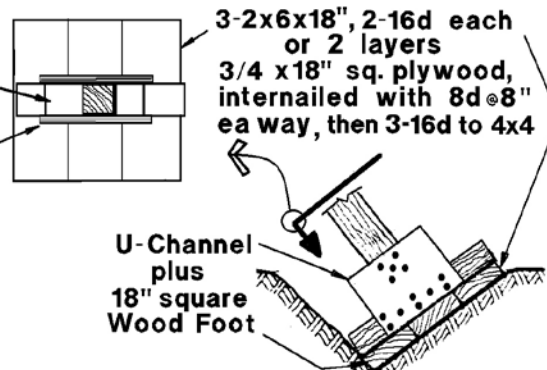
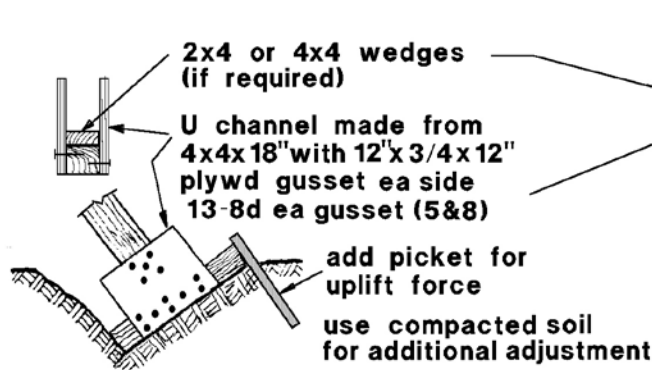
## RAKER SHORE CONNECTIONS

SHOR - 15 8 06/08



### NAILED TOP

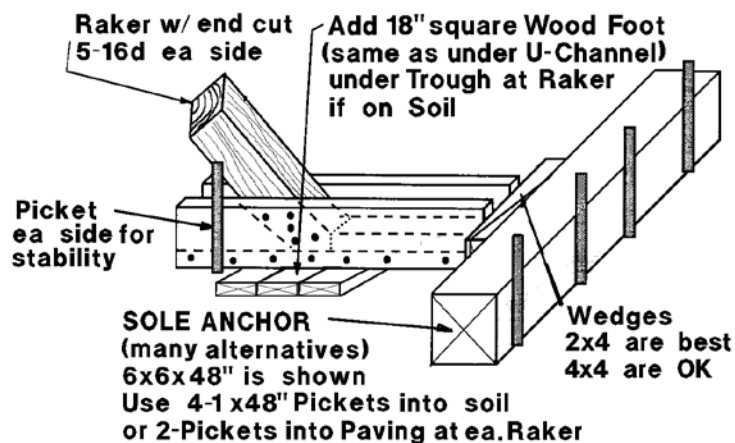
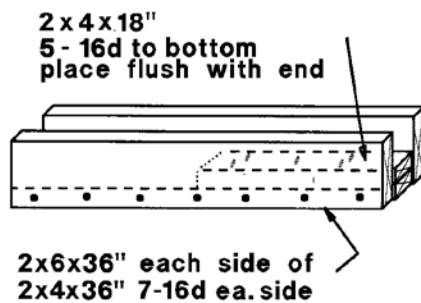
### RAKER END CUT



### AT FLYING RAKER

### DETAILS at U-CHANNEL BASE

### AT SPLIT SOLE RAKER



### TROUGH DETAIL

### DETAILS at TROUGH BASE

Preferred Base at Split Sole & Flying Rakers. No need for digging

### FABRICATION AND ERECTION

- ALL RAKERS SHOULD BE FABRICATED IN AN AREA AWAY FROM A DAMAGED MASONRY WALL, SINCE AFTERSHOCK COULD CAUSE COLLAPSE
- AFTER FABRICATION, THE RAKERS NEED TO BE CARRIED OR WALKED TO THE WALL, AND ADJUSTED FOR TIGHT FIT.

Figure 6:59

## Appendix A: Glossary



---

# RESCUE SYSTEMS 1

Basic Rescue Skills

---

## Appendix A. Glossary

---







# RESCUE SYSTEMS 1

## Basic Rescue Skills



### Appendix A. Glossary

ALS	Advanced life support
ANSI	American National Standards Institute
BLS	Basic life support
CAL FIRE	California Department of Forestry and Fire Protection
CBRNE	Chemical, biological, radiological, nuclear, explosive
CCP	Casualty collection point
CCR	California Code of Regulations
CERT	Community Emergency Response Team
CIP	Cast-in-place concrete
CMU	Concrete masonry unit
CP	Command Post (also known as ICP)
DART	Disaster Assistance Response Team
DOC	Department Operating Center
EICC	Emergency Information and Coordination Center (Washington D.C.)
EM	Electromagnetic
ESF	Emergency support functions
Extensive/grid search	Secondary search
FEMA	Federal Emergency Management Agency
FIRESCOPE	Firefighting Resources Organized for Potential Emergencies
FOG	Fire Service Field Operations Guide
FRA	Hazardous Materials First Responder Awareness Level
FRO	Hazardous Materials First Responder Operational Level
Glulam	Glued-laminated wood beams
Hasty search	Primary search
HSPD	Homeland Security Presidential Directive
IAP	Incident action plan
IC	Incident Commander
ICP	Incident Command Post (also known as CP)
ICS	Incident command system
LCES	Lookouts, Communications, Escape Routes, and Safe Zones
NRP	National Response Plan
NFA	National Fire Academy
NFPA	National Fire Protection Association
OES	California Governor's Office of Emergency Services
OSD	Operational System Description
OSFM	California Office of State Fire Marshal
OSHA	Occupational Safety and Health Administration
PAR	Personal Accountability Report
PPE	Personal protective equipment
Rebar	Steel reinforcing bars
Recon	Reconnaissance
RM	Reinforced masonry



# RESCUE SYSTEMS 1

## Basic Rescue Skills

### Appendix A. Glossary



ROC	Regional Operations Center
TU	Tilt-up concrete
URM	Unreinforced masonry
US&R	Urban Search and Rescue
US&R Company	Personnel with vehicle(s) and equipment trained and equipped to conduct search and rescue operations at incidents where technical expertise and equipment are required
US&R Crews	Personnel without vehicle(s) or equipment trained to conduct search and rescue operations at incidents where technical expertise is required.
WMD	Weapons of mass destruction



---

# RESCUE SYSTEMS 1

## Basic Rescue Skills

---

### Appendix B: Rope Rescue Scene Management

---



## APPENDIX B: ROPE RESCUE SCENE MANAGEMENT



---

---

# RESCUE SYSTEMS 1

## Basic Rescue Skills

---

---

### Appendix B: Rope Rescue Scene Management

---

---



**TERMINAL OBJECTIVE:**

The student will understand and be able to operate within the Incident Command System (ICS).

**ENABLING OBJECTIVES:**

1. Describe rescue scene organization and management.
2. Describe command and control in rope rescue operations.
3. Describe rope rescue position descriptions.
4. Describe ICS and rope rescue operations.

The Incident Commander sets the tone for the successful management of the incident by implementing a command structure, giving clear objectives and assignments, and coordinating the activities of the various responders.

**Command and Control in Vertical Rope Rescue Operations**

- The Incident Command System (ICS) is the framework for managing any incident.
- Prior training in ICS is important so everyone knows where they fit into the system.
- Small incidents can be managed by one person wearing all the hats.
- The ICS expands as the incident grows to maintain an efficient span of control.
- Incidents that involve more than one jurisdiction may be managed by Unified Command.
- Positions that may need to be filled on an "typical" vertical rope rescue incident include:
  - Incident Commander (IC)
  - Safety Officer (this role may be retained by the IC)
  - Rescue Group Supervisor
  - Assistant Safety Officer—Rope Rescue
  - Rigging Team
  - Haul Team
  - Edge Person
  - Main Line Tender
  - Belay/Safety Line Tender
  - Rescuer(s)

**ICS and Rope Rescue Operations**

First arriving responder assumes IC, performs size-up, and ensures adequate resources are requested; may initiate lowering operation or rappel operation to put a rescuer into contact with victims.

- Command may be transferred to more qualified personnel as they arrive.
- Incoming resources are assigned as needed by the IC or may be staged pending assignment or release.



# RESCUE SYSTEMS 1

## Basic Rescue Skills



### Appendix B: Rope Rescue Scene Management

#### ***Position Descriptions***

##### ***Incident Commander (IC)***

- Is responsible for the overall management of the incident
- Assesses the situation and/or obtains a briefing from the previous Incident Commander
- Determines and communicates incident objectives and strategy
- Establishes the immediate priorities
- Ensures personnel safety and personnel incident accountability
- Communicates as needed with dispatch or emergency command center

##### ***Safety Officer***

- Identifies hazardous situations associated with the incident
- Develops and recommends measures for assuring personnel safety
- Stops or prevents any unsafe act
- Assigns Assistant Safety Officer(s) as needed; competent rope rescuer to safety-check and oversee rope rescue operation

##### ***Operations Section Chief***

- If used, is responsible for the management of all operations directly applicable to the actual rescue
  - Briefs, assigns, and supervises personnel assigned to the operations section including Rescue Group Supervisor, Medical Groups Supervisor, etc.
  - Determines need and requests additional resources
- Depending on available staffing for the incident, the IC sometimes retains this function and does not assign a separate Operations Chief.

##### ***Group Supervisors***

- May include Rescue Group Supervisor, Extrication Group Supervisor, Medical Group Supervisor, etc., depending on the size and complexity of the incident
- Report to the Operations Chief (if one is assigned) or IC

##### ***Rescue Group Supervisor***

- Assigns personnel to positions as needed
- Supervises activities related to the actual rescue operation
- Supervises Rigging and Haul Team Leaders and Rescuer
- Ensures safety checks are performed as needed

#### Assistant Safety Officer – Rope Rescue (ASO)

- Reports to the Incident Safety Officer
- Coordinates with Rescue Group Supervisor
- Must be competent in vertical rope rescue operations
- Is responsible for the technical accuracy and safety of the rope rescue operations
- Oversees safety of actual vertical rescue operations
- Safety checks all components of lowering/raising system
  - The person who safety checks the system components shall not be the person who rigged them.
  - When staffing is limited, personnel can safety-check each other's work.
  - Perform continuous safety checks.
  - Safety-check AFTER the rescuer is attached to main and safety-check BEFORE lines are loaded.

#### *Rigging Team Leader*

- Oversees rigging and operation of rope systems and ensures safety checks are completed
- May move to another position after rigging is complete

#### *Rigger*

- Assembles rope rescue systems in place
- Moves into other positions after rigging is complete

#### *Edge Person*

- Watches over edge for safety and coordination issues
- Serves as communication link between rescuers and Rescue Group Supervisor

#### *Mainline Tender (lowering)*

- Operates rope and friction device to lower rescuer

#### *Belay/Safety Line Tender*

- Operates belay/safety line to ensure safety of personnel being lowered or raised by rope system

#### *Haul Team Leader*

- Oversees operation of mechanical advantage haul system

#### *Hauler*

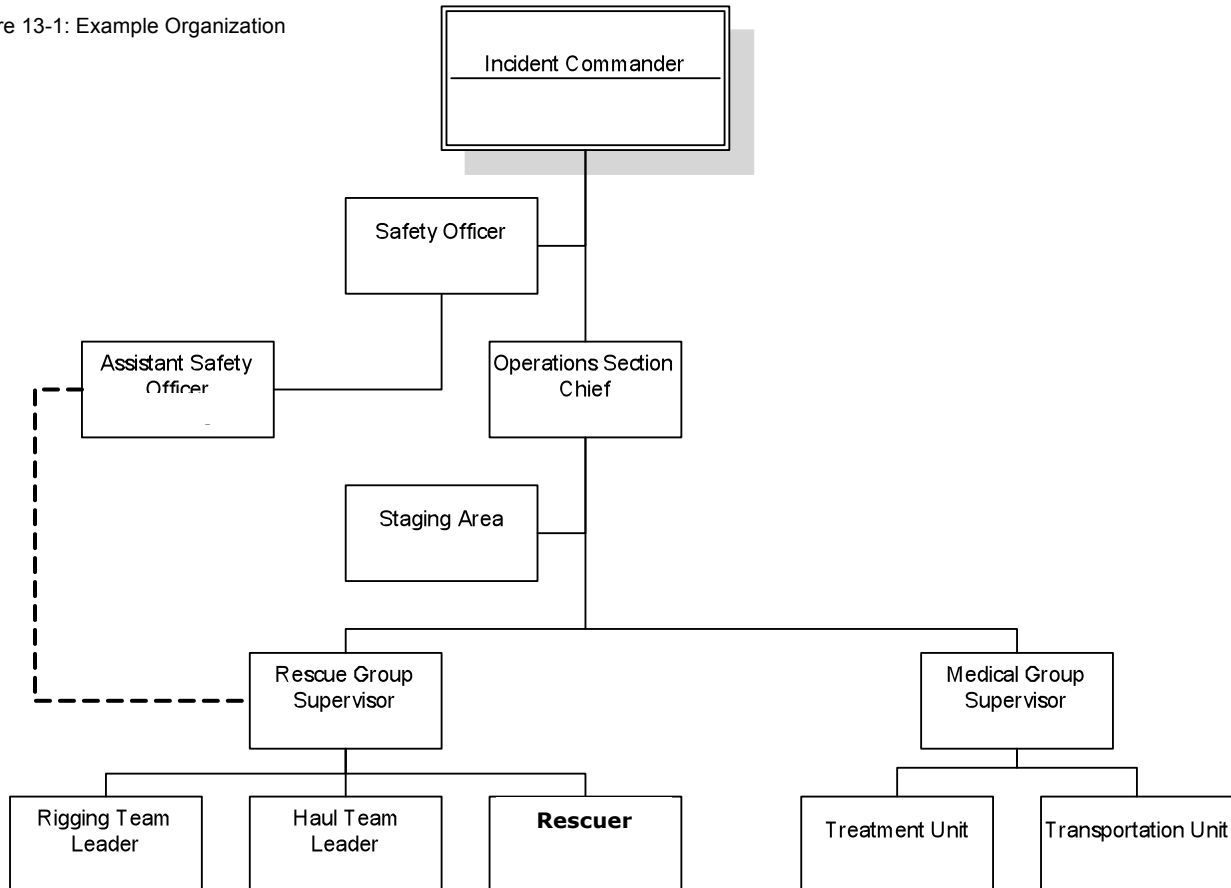
- Controls main line during raising operations

#### *Rescuer*

- Accesses and stabilizes victim
- Assesses victim's condition and advises Rescue Group Supervisor of best rescue operation
- Secures victim in litter or harness
- May tend ground litter tender lines
- May be raised or lowered with victim as attendant

The following is an example of an organization chart. Each agency may use its own organization chart and fill positions as it sees fit.

Figure 13-1: Example Organization





#### ☐ Size-up

- Will ropes be used?
- Is rope system is to be used
  - In-line?
  - Directional change?
  - Piggyback?
- Are sufficient personnel responding? (Includes filling necessary ICS functions and staffing haul and litter teams.)
- Consider staging resources until needed.
- Establish objectives (DLAST).
  - Detect the victims using skid marks, eyewitness accounts, collapse patterns, etc., to indicate their rough location.
  - Locate the victims.
    - ◆ Confirm the actual location of the victims.
    - ◆ Determine alternative routes of access to victims.
  - Access the victims. Rescuer may rappel to or be lowered to victims' location.
  - Stabilize the victims and package in harness or litter.
  - Transport the victims, either tended or untended.
- Use standardized field commands for the local areas. It is very beneficial to have cooperating agencies use the same standardized field commands.
- Debriefing and documentation examples of information to gather and document may include the following timelines:
  - Rescue Operation: At scene, rescuer deployed, victim topside, rescuer topside, clear
  - Patient Care: First care, EMS hand-off, ALS care initiated, time and method of transport
  - Technical Operations: Lowering system distance, anchor(s) used, equipment and safety issues, training needs
  - Scene Management: ICS used, SOP (or G) used, overall evaluation
  - Interagency Effectiveness: communication, staging, interface

## **Introduction to Rope Rescue Lowering and Raising Systems**

### **Lowering System Operation**

#### ***Crew Assignments***

- Edge Person
  - Coordinates the operation
  - Gives orders to
    - Main Line Tender
    - Belay/Safety Line Tender
    - Rescuer
- Main Line Tender—manages the main line to lower the rescuer/victim
- Belay/Safety Line Tender—manages the belay system

#### ***Safety Checks***

- Are performed prior to operation of the system
  - All anchor components
  - All belay systems components
  - All main line components
  - Rescuer/victim packaging
- Ensure that all parts of the system are properly assembled, tied, and secured
- Are performed by a member of the crew who has not constructed that component or Assistant Safety Officer—Vertical Rope Rescue

#### ***Commands***

- Designed to
  - Coordinate the operation
  - Ensure consistent communications
  - Ensure instant response in the event of an emergency
- Readiness check commands
  - Edge Person to Belay/Safety Line Tender: ON BELAY?
  - When ready, Belay/Safety Line Tender to Edge Person: BELAY ON.
  - Edge Person to Main Line Tender: READY ON MAIN LINE?
  - When ready, Main Line Tender to Edge Person: MAIN LINE READY.
  - Edge Person to Rescuer: RESCUER READY?
  - When ready, Rescuer to Edge Person: READY.



# RESCUE SYSTEMS 1

## Basic Rescue Skills



### Appendix B: Rope Rescue Scene Management

- Operation commands
  - Edge Person to Main Line Tender
    - DOWN.
    - To increase the lowering speed, calls out DOWN, DOWN.
    - To stop the operation, calls out STOP.
  - Any member of the crew who needs to stop the operation may call out STOP.

### **Raising System - Changeover from Lowering to Raising System**

#### ***Crew Assignments***

- Edge Person
  - Coordinates the operation
  - Gives orders to
    - Haul Team Leader
    - Belay/Safety Line Tender
- Haul Team Leader—manages the changeover from a lowering system to a raising system
- Belay/Safety Line Tender—converts lowering belay to raising belay

### **Operation of Raising System**

#### ***Crew Assignments***

- Edge Person
  - Coordinates the operation
  - Gives orders to
    - Haul Team Leader
    - Belay/Safety Line Tender
    - Rescuer
- Haul Team Leader—directs the Haul Team on the main line to raise the Rescuer/victim
- Belay/Safety Line Tender—manages the belay system

#### ***Safety Checks***

- Are performed prior to operation of the system
  - All anchor components
  - All belay systems components
  - All main line components
  - Rescuer/victim packaging
- Ensure that all parts of the system are properly assembled, tied, and secured
- Are performed by a member of the crew who has not constructed that component

## ***Commands***

- Designed to
  - Coordinate the operation
  - Ensure consistent communications
  - Ensure instant response in the event of an emergency
- Readiness check commands
  - Edge Person to Belay/Safety Line Tender: ON BELAY?
  - When ready, Belay/Safety Line Tender to Edge Person: BELAY ON.
  - Edge Person to Haul Team Leader: READY ON MAIN LINE?
  - When ready, Haul Team Leader to Edge Person: MAIN LINE READY.
  - Edge Person to Rescuer: RESCUER AND VICTIM READY?
  - When ready, Rescuer to Edge Person: READY.
- Operation commands
  - Edge Person to Haul Team Leader
    - UP.
    - To increase the raising speed, calls out UP, UP.
    - To stop the operation, calls out STOP.
  - When the Haul Team has raised the system to the point where the mechanical advantage pulley (moving pulley) on the main line is close to the RPM, Haul Team Leader calls out SET.
  - After the Haul Team has set the ratchet prusik, Haul Team Leader calls out RESET.
    - A Haul Team member resets the mechanical advantage pulley.
    - Process is repeated as necessary.
  - Any member of the crew who needs to stop the operation may call out STOP.
  - To disconnect rescuer/victim: provide slack in main line (release ratchet prusik) and belay/safety line.

Example of Organization of a Vertical Rope Rescue Using 3-Person Engines

## First Arrival Considerations

- Size-up
  - Location of victim
  - Resource needs
  - Staffing
- Anchor system
  - Natural
    - Adequate
    - System compatible for directional or in-line operations
  - Vehicle
    - Wheels
    - Hooks
      - ◆ Provision of adequate workspace
      - ◆ MA direction/layout
      - ◆ Placement
  - Structure
    - Structural members or components
    - Machinery
    - Furniture or tools in doors and windows



# RESCUE SYSTEMS 1

## Basic Rescue Skills



### Appendix B: Rope Rescue Scene Management

#### **Step #1: Scene Assessment and Rigging**

##### ***First Engine***

- E1 Company Officer: Incident Commander/Safety Officer/Rigging Team Leader
- E1 Fire Fighter 1: Rigger
- E1 Fire Fighter 2: Rigger/Rescuer
- Attach RPM and provide edge protection.
- Package and attach rescuer (E1 Fire Fighter 2) and perform mandatory safety check.

#### **Step #2: Initial Victim Contact**

##### ***First Engine***

- E1 Company Officer: Incident Commander/Safety Officer/Rope Group Supervisor/Edge Person/Main Line Tender
- E1 Fire Fighter 1: Belay/Safety Line Tender
- E1 Fire Fighter 2: Rescuer
- Lower rescuer.
- Assess victim.

#### **Step #3: Victim Retrieval**

##### ***Second Engine***

- E2 Company Officer: Haul Team Leader
- E2 Fire Fighter 1: Haul Team
- E2 Fire Fighter 2: Haul Team

##### ***Third Engine***

- E3 Company Officer: Assistant Safety Officer or Hauler
- E3 Fire Fighter 1: Main Line Tender or assign as needed; relieves E1 Company Officer as Main Line Tender if needed
- E3 Fire Fighter 2: Haul Team
- E3 Fire Fighter 2: Haul Team

## Sample Organization Chart

May be revised as needed depending on the incident.

### Step 1: Scene Assessment and Rigging

Positions shown in parenthesis are filled or retained by a person filling multiple positions.

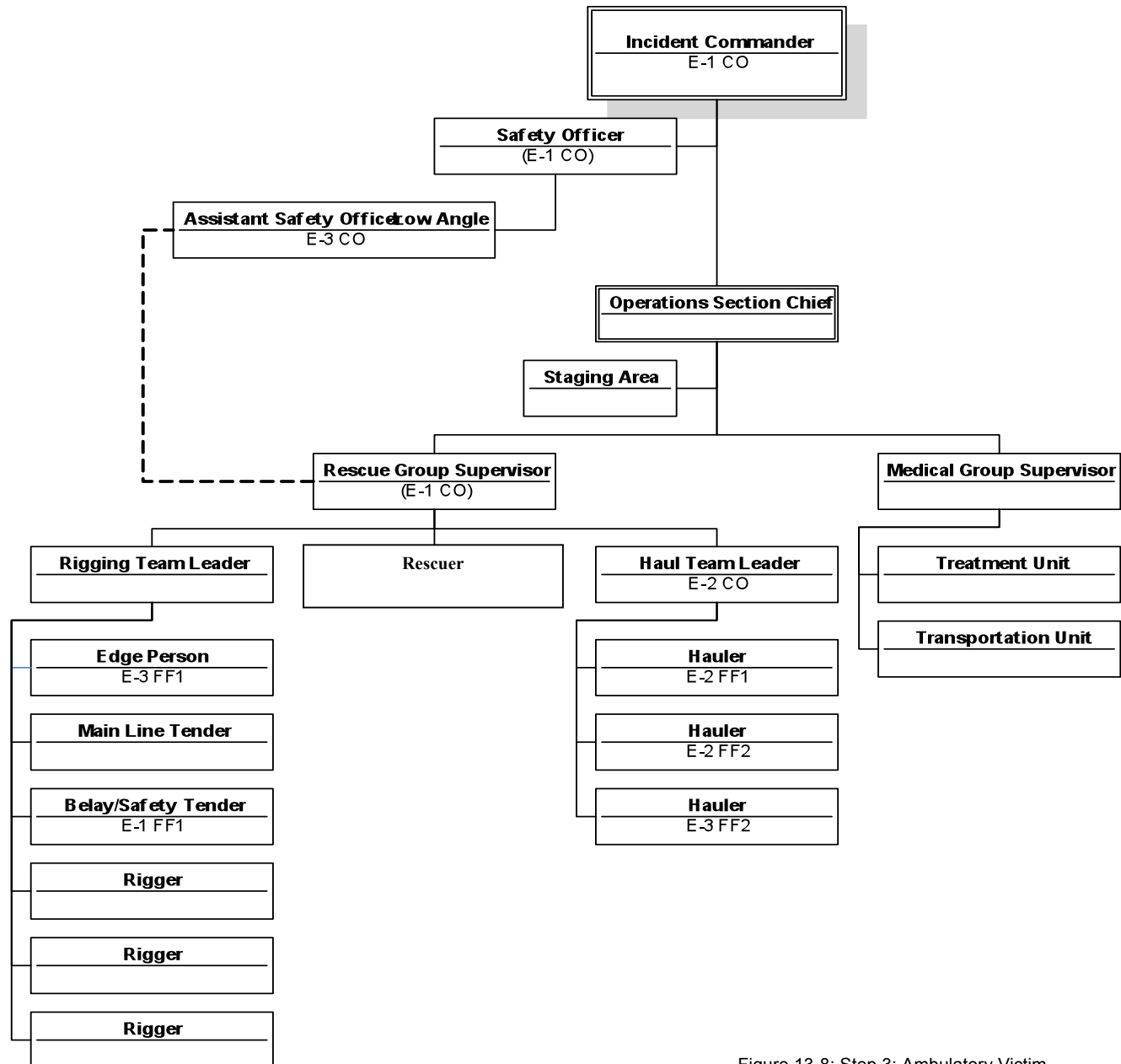


Figure 13-8: Step 3: Ambulatory Victim Walkout



---

# RESCUE SYSTEMS 1

## Basic Rescue Skills

---

### Appendix B: Rope Rescue Scene Management

---







---

# RESCUE SYSTEMS 1

Basic Rescue Skills

---



Appendix C: Sample Class III Harness Information Card

---

## **APPENDIX C: SAMPLE CLASS III HARNESS INFORMATION CARD**



---

---

# RESCUE SYSTEMS 1

## Basic Rescue Skills

---

---

### Appendix C: Sample Class III Harness Information Card



### Limited Warranty

Yates Gear Inc. warrants for one year from the purchase date and only to the original retail buyer that our products are free from defects in material and workmanship. If the buyer discovers a warranty related defect, the buyer should return the product to Yates Gear Inc. Yates Gear Inc. reserves the option to repair or replace any product returned under warranty. That is the extent of our liability under this warranty and, upon the expiration of the applicable warranty period, all such liability shall terminate.

### Warranty Exclusions

Yates Gear Inc. does not warrant products against normal wear and tear, unauthorized modification or alteration, improper use, improper maintenance, accident, misuse, negligence, damage, or if the product is used for a purpose for which it was not designed. This warranty gives you specific legal rights, and you may also have other rights which vary from state to state. Except as expressly stated in this warranty, Yates Gear Inc. shall not be liable for direct, indirect, incidental, or other types of damages arising out of, or resulting from the use of the product.

### Warning

Products manufactured by Yates Gear Inc. are intended for use by professionals trained and experienced in the use, inspection, and maintenance of these products. Many products which Yates manufactures are used in high angle environments which pose a very substantial risk of serious injury or death. You must read and understand all of the manufacturer's instructions before use. Any person purchasing this equipment assumes the responsibility for seeking proper training in its use. Purchaser also assumes all risk for any injury or damage sustained while using any of this equipment. Failure to follow these warnings increases the risk of injury and death.

**Keep this user instructions/information sheet as a permanent record after it is separated from the harness/belt, and make a copy to be kept with the harness/belt.**

It is suggested that the user refer to this user information sheet before and after each use of the harness/belt.

Do not alter or intentionally misuse this harness in any way. Any alterations or repairs to this harness should be conducted by the manufacturer only.

Use caution when using this equipment around moving machinery, electrical hazards, sharp edges, chemical hazards and high heat environment or flame. Carry the harness/belt where it will be protected as the harness/belt could melt or burn and fail if exposed to flame or high temperature.

This sheet has been prepared in accordance with the requirements of NFPA 1983 (2006 edition).

If you have any questions concerning the condition of your harness/belt, or have any doubt about putting it into service contact manufacturer.

380	Voyager
Harness	



### Yates Gear Inc.

2608 Hartnell Ave. Suite 6, Redding, CA. 96002

Phone/Fax 800-Yates-16 (800-928-3716)

Phone 530-222-4606 Fax 530-222-4640

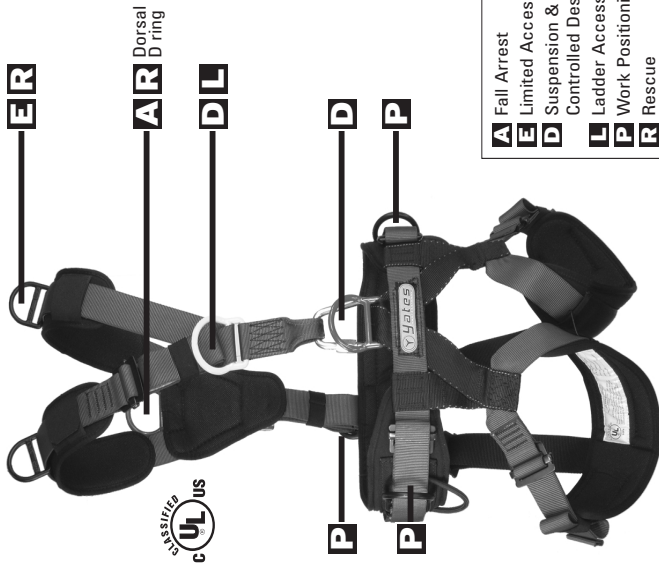
[www.yatesgear.com](http://www.yatesgear.com)



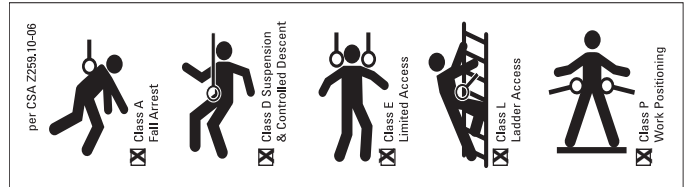
### 380 Voyager Harness

The Voyager has become the standard of the rescue professional who needs a versatile harness with multiple attachment points. 5 inch waist provides extreme comfort. Quickly and easily donned and adjusted by use of camlock buckles. Wider leg pads for more comfort. Attachment points at waist, hips (positioning), chest (sternum), back (lumbar), back (dorsal) and shoulders. Weight 6 lbs.

- Sizes S, M, L, XL
- Large D rings for multiple connections
- Certified to NFPA 1983/2006 ed. standards
- Meets ANSI/OSHA and CAN/CSA Class III harness standards



- A** Fall Arrest
- E** Limited Access
- D** Suspension & Controlled Descent
- L** Ladder Access
- P** Work Positioning
- R** Rescue



**Yates** PROFESSIONAL EQUIPMENT

SIZE/GRAUNDEUR:  S  M  L  XL

GROUP:  A  D  E  L  P

CLASS III FULL BODY HARNESS

CAPACITY 330 LBS., NYLON WEB

MADE IN U.S.A.

INSPECTION LOG	2005	2006	2007	2008	2009	2010

USER IDENTIFICATION MARK WITH PERMANENT MARKER

DO NOT REMOVE THIS LABEL REC 12006

**WARNING! DO NOT REMOVE THIS LABEL**

- You could be killed or seriously injured if you do not read and understand this label before using harness.
- Special training and knowledge are required to use this harness.
- The user is responsible for understanding the intended use of this harness.
- You must thoroughly read and understand all manufacturer's instructions before use.
- Use and inspect harness only in accordance with the manufacturer's instructions.
- Refer to additional manufacturer's instructions furnished with this harness before use.

You can contact the manufacturer at: Yates Gear Inc, 2608 Hartnell Avenue #6, Redding CA 96002. Phone: 1-800-928-3716 for important safety information. Do not remove this label!

Double-back webbing through buckle as shown leaving a minimum of 3 inches of tail.

**CLASSIFIED**  
**UL**  
**93F4**

EMERGENCY SERVICES LIFE SAFETY FULL BODY HARNESS IN ACCORDANCE WITH NFPA 1983-2006 ED. AND CAN/CSA-Z259.10-M90

MANUFACTURED BY YATES GEAR, INC. MADE IN USA. MATERIAL: NYLON

THIS LIFE SAFETY HARNESS MEETS THE HARNESS REQUIREMENTS OF NFPA 1983, STANDARD ON LIFE SAFETY ROPE AND EQUIPMENT FOR EMERGENCY SERVICES 2006 EDITION; CLASS III

TYPE OF HARNESS \_\_\_\_\_

LOT & DATE OF MFG. \_\_\_\_\_

CLASS III ONE PIECE HARNESS:

FITS WAIST SIZE \_\_\_\_\_

FITS HEIGHT \_\_\_\_\_

**CLASS III FULL BODY HARNESS**  
CAPACITY 330 LBS. (140 KG)  
MATERIAL: NYLON  
ANSI Z359.1-1982 / ANSI Z359.2-2000  
OSHA 1910.146, NFPA 1983-2001 ED,  
ASTM F887-96, CSA-Z259.10-M90

ALWAYS USE SELF-LOCKING SNAP LINKS

ALL OTHER D-RINGS ON HARNESS SYSTEMS SHOULD ONLY BE ATTACHED TO D-RING LOCATED ON BACK OF HARNESS BETWEEN SHOULDERS

IF FALL ARREST IS REQUIRED ALL OTHER D-RINGS ON HARNESS ARE FOR APPLICABLE CONNECTIONS: L=LADDER CLIMBING (IF PRESENT) D=DESCENT CONTROL (IF PRESENT) P=WORK POSITIONING (IF PRESENT)

SEE INSTRUCTIONS FOR MORE DETAILS

DO NOT REMOVE THIS LABEL REC 11006

Labels Located Inside Vinyl Wrap Located on Dorsal D Ring Adjustment Strap

### 380 Voyager Harness

Designed for use as a Type I full body harness per the requirements set forth in ANSI Z359.1-1992. Certified by Underwriters Laboratories Inc. to meet the harness requirements of NFPA 1983 Standard on Fire Service Life Safety Rope and Equipment for Emergency Services 2006 edition; Class III full body harness, CAN/CSA-Z259.10-M90, ANSI Z359.1-1992 (rev. 1999).

### Usage and Applications

Large forged D ring located in the rear between the shoulders should be used for all Class III full body applications for general fall arrest protection. Attach only ANSI/OSHA approved lanyards to rear D ring. Maximum free fall distance allowed is 6 feet. Attachment of ANSI/OSHA approved shock absorbing/decelerating device is required at this attachment point for all fall arrest protection applications.

Two D rings located on top of the shoulders should be used for lowering situations such as in confined space rescue when a long hang time is anticipated. The use of a Y lifting bridle is recommended for use with upper shoulder D ring attachments for lowering in confined space applications.

**Maximum capacity of harness is 310 lbs. per ANSI Z359.1-1992 (rev. 1999)**

### Before Use

The techniques employed in the proper and safe use of this equipment may only be learned through *personal* instruction received from an instructor who is well-qualified in all phases of vertical rope work. Such instruction will include an evaluation of your comprehension of, and ability to perform, the tasks required to safely and efficiently use this equipment. Never attempt its use until you have received such instruction and are believed competent by your instructor.

### Donning and Fitting the Harness

First inspect entire harness: see section Maintenance, Service, Storage  
Step 1: Locate red rear fall arrest D ring located on rear of harness. Hold harness up by this D ring and ensure that the straps are not twisted.

Step 2: Loosen all adjuster buckles by lifting up on side tabs located on front of buckle. Adjuster buckles are located on front of harness at waist, on leg of harness and on right shoulder. Loosen shoulder completely.

Step 3: Step into seat portion of harness allowing chest portion of harness to hang on your left side. Tighten waist portion of harness to be snug.

Step 4: Pull right shoulder strap over head and tighten. It is not necessary to disconnect front chest screw link for donning. **Ensure chest screw link is securely tightened before use.** Large D ring should be located on your back between shoulder blades.

Step 5: Make certain straps are not tangled and hang freely. Silver chest D ring will be positioned in front. Adjust all buckles to be snug starting with leg straps, then waist, shoulders and chest. Always adjust harness from the legs working up the harness. It is not necessary to tie off any adjuster buckles on this harness. Secure webbing ends in elastic keepers.

### Sharp Edges

Avoid working where the harness will be in contact with, or abrade against, unprotected or sharp edges. If working with this equipment near sharp edges is unavoidable, protection against cutting should be provided by using a heavy pad or other means over the exposed edge.

### Roll Out

When using a hook to connect to an anchor or when coupling components of a system together, be certain accidental disengagement (roll out) cannot occur. Roll out occurs when a hook is snapped into an undersized ring or non-compatible shaped connector (D ring) causing the hook's gate or keeper to accidentally open and release. Self-locking snap hooks or self-locking and self-closing gate carabiners should be used to reduce the possibility of roll out. Do not attach two snap hooks onto one D ring.

### After a Fall

Harnesses which have been subject to the forces involved in arresting a fall must be removed from service and destroyed.

### Maintenance, Service, Storage

Before and after each use, inspect this harness to ensure that it is in a serviceable condition. Check for worn or damaged parts. Ensure all hardware (D rings, buckles, etc.) are present. Inspect to ensure that all buckles work properly and that they do not have any sharp edges, burrs, cracks or corrosion. Inspect webbing for wear, cuts, burns, frayed edges or other damage. Inspect all stitching for abrasion, discoloration and wear to ensure integrity. Thoroughly inspect harness after any period of extended storage. Store harness in a cool, dry, clean environment out of direct sunlight. Do not expose harness to flame or high temperature environments. Avoid contact with any corrosive or caustic chemical agents such as acids, bases, or petroleum products. Discontinue use of product if it has come in contact with any of the above listed or any suspect chemical agents. Avoid storage and use of harness in areas where chemical vapors may exist. Discontinue use of harness and remove from service if inspection reveals an unsafe condition.

### Cleaning

Clean harness with warm water in a mild detergent solution. Wipe off hardware with clean, dry, cloth and hang to air dry. Do not force dry with heat.

### Additional Information

Additional information regarding this type of equipment can be found in the following publications:

NFPA 1500, Standard on Fire Department Occupational Safety and Health Program

NFPA 1983, Standard on Life Safety Rope and Equipment for Emergency Services

ANSI Z359.1 Safety Requirements for Personal Fall Arrest Systems, Subsystems and Components

### Records

It is suggested that the user of this harness keep a permanent record listing the date and results of each usage inspection. Such record should show, as a minimum, inspection criteria as written in section Maintenance, Service, Storage.

### Use of this User Information Sheet

It is suggested that this user information sheet be retained in a permanent record after it is separated from the harness/belt, and that a copy of it be kept with the harness/belt.

It is suggested that the user refer to this user information sheet before and after each use of the harness/belt.

### WARNING!

- ***This product is part of a personal protective, rescue or work support system.***
- ***You must read and follow the manufacturer's instructions for this product and each component of the complete system.***
- ***You are responsible for understanding the intended use on this harness, and the intended application and use of each of the multiple attachment points located on this harness.***
- ***You could be killed or seriously injured if you do not read and understand the user information before using this piece of equipment.***
- ***The user of this equipment should formulate a rescue plan and the means at hand to implement it when using this equipment.***
- ***Special training and knowledge are required to use this equipment.***
- ***Use and inspect this equipment only in accordance with these instructions.***

### Camlock Buckle System (if applicable)

Thread camlock buckle by inserting the free end of the webbing from under the buckle over the top of the center bar slide portion of buckle assembly. Ensure that the adjuster bar is located on the top of the buckle assembly. Tighten the buckle by pulling on the free end of the webbing. Secure the free end of the webbing with the elastic keeper.

The buckle will adjust easier when tightening if the buckle is opened slightly by lifting on the tabs located on the side of the buckle while securing. To loosen the buckle, lift on the tabs located on the side of the buckle until the buckle is past vertical.

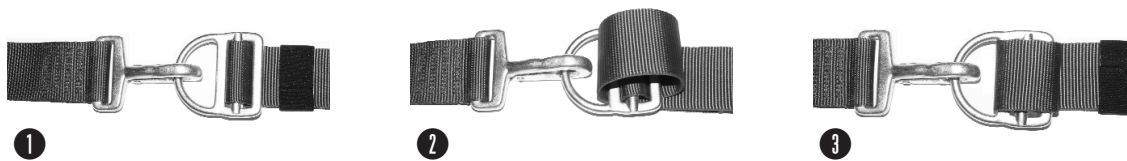


### Quick Connect Snap Hook and D Ring Adjuster Assembly (if applicable)

Step 1: Pull on tail end of webbing to tighten assembly

Step 2: Insert tail end of webbing through D portion of adjuster

Step 3: Tighten tail of webbing under the assembly and secure the tail in elastic keepers



### Double Buckle Assembly Safety Lock (if applicable)

Safety lock all pass through double buckles by inserting the free end of the webbing back over the top of three bar slide portion of the buckle assembly. Secure the free end of the webbing with the elastic keeper.



### Important Note: Instructions Regarding Anchorage Requirements for Personal Fall Arrest Systems (PFAS)

The anchorage selected for a personal fall arrest system (PFAS) shall have a strength capable of sustaining static loads applied in direction permitted by the PFAS of at least:

- (a) 3600 lbs. (16kN) when certification exists, or
- (b) 5000 lbs. (22.2kN) in absence of certification

When more than one PFAS is attached to a single anchorage, the anchorage strength set forth in (a) and (b) above shall be multiplied by the number of PFAS's attached to the anchorage.



---

# RESCUE SYSTEMS 1

## Basic Rescue Skills

---



### Appendix D: Victim Chest Harness Information Card

---

## APPENDIX D: VICTIM CHEST HARNESS INFORMATION CARD



# RESCUE SYSTEMS 1

## Basic Rescue Skills



### Appendix D: Victim Chest Harness Information Card



## Appendix D: Victim Chest Harness Information Card

### CARRYING, MAINTENANCE & STORAGE

During use, carrying, and storage keep the harness away from acids, alkalis, exhaust emissions, rust and strong chemicals. Do not expose the harness to flame or high temperatures. Carry the harness where it will be protected as the harness could melt or burn and fail if exposed to flame or high temperatures.

This harness is comprised of nylon webbing and thread. If the harness becomes soiled, it can be washed in cold water with a mild detergent. CMC Rescue recommends the use of LifeLine Cleaner. For decontamination, the strap may be cleaned per your department's protocols on bio-hazards. Dry out of direct sunlight. Do not dry in an automatic dryer. Store in a cool, dry location.

### REPAIR

CMC Rescue recommends that all repair work be done by the manufacturer. All other repair work or modification of the harness performed elsewhere may void the warranty, and releases CMC Rescue from all liability and responsibility as the manufacturer.

### SAMPLE INSPECTION AND MAINTENANCE LOG

The sample log suggests records that should be maintained by the purchaser or user of rescue equipment.

Equipment Inspection and Maintenance Log			
Item _____ # _____	Date in Service _____		
Brand/Model _____	Strength _____		
Date	How Used or Maintained	Comments	Name

The CMC ProSeries Lifesaver Victim Chest Harness is designed to work with the ProSeries Lifesaver Victim Harness to provide upper body support to the victim. It is especially useful in confined space situations where it keeps the victim in an upright position.

### THE USER INSTRUCTIONS

NFPA Standard 1983 recommends separating the user instructions from the harness and retaining them in permanent record. The standard also recommends making a copy of the instructions to keep with the harness and that the instructions should be referred to before and after each use.

### INSPECTING YOUR HARNESS

Inspect the harness according to your department's policy for inspecting life safety equipment. The harness should be inspected after each use and at least once a year by an inspector that meets your department's training standard for inspection of life safety equipment. Record the date of the inspection and the results in the equipment log or on a tag that attaches to the harness. Each user should be trained in equipment inspection and should do a cursory inspection, and check component compatibility before each use.

When inspecting the harness, check the webbing for cuts, worn or frayed areas, broken fibers, soft or hard spots, discoloration, or melted fibers. Check the stitching for pulled threads, abrasion, or breaks. Check the hardware for damage, sharp edges, and improper operation. If any of the above are noted, or if the harness has been subjected to shock loads, fall loads, or abuse other than normal use, remove the harness from service and destroy it. If there is any doubt about the serviceability of the harness, remove the harness from service and destroy it.

### IMPORTANT INSTRUCTIONS - PLEASE READ AND SAVE



## CMC ProSeries® Lifesaver Victim Chest Harness

Made in USA



### CMC Rescue, Inc.

P. O. Box 6870, Santa Barbara, CA 93160 USA  
805-562-9120  
www.cmcrescue.com

### ISO 9001: 2000 Certified

© 1998, CMC Rescue, Inc., Control No. 202404.02.021706

### DONNING THE HARNESS

After the Lifesaver Victim Harness has been placed on the subject:

- 1.) Clip the bottom D-Ring of the Lifesaver Victim Chest Harness into the orange loop of the Lifesaver Victim Harness using a locking carabiner.
  - 2.) Wrap the padded strap around the victim's upper chest and connect the adjuster buckle into the V-Ring. Adjust the strap so that it is snug but not constricting.
  - 3.) Slide the padding on either side of the victim's back for maximum comfort.
- As with all rescue equipment, adequate training and regular practice with the equipment is necessary for efficient and safe use.



### TYING IN

The Main Line should be attached to the upper D-Ring of the Lifesaver Victim Chest Harness using a second locking carabiner. Anchorage points should always be situated above the user.

**To prevent roll out when using carabiners , use only locking models and verify that they are locked before use. Follow your industry's protocol for selecting compatible connectors and system components.**



# RESCUE SYSTEMS 1

## Basic Rescue Skills



### Appendix D: Victim Chest Harness Information Card



---

# RESCUE SYSTEMS 1

Basic Rescue Skills

---



Appendix D: Victim Chest Harness Information Card

---

## APPENDIX E: VICTIM PELVIS HARNESS INFORMATION CARD



---

---

# RESCUE SYSTEMS 1

## Basic Rescue Skills

---

---

### Appendix E: Victim Pelvic Harness Information Card

---

---



### Appendix E: Victim Pelvic Harness Information Card

**To prevent roll out when using carabiners to attach to an attachment point, use only locking models. If using manual locking carabiners, verify that they are locked before use. Follow your industry's protocol for selecting compatible connectors and system components.**

#### CARRYING, MAINTENANCE & STORAGE

During use, carrying, and storage keep the harness away from acids, alkalis, exhaust emissions, rust and strong chemicals. Do not expose the harness to flame or high temperatures. Carry the harness where it will be protected as the harness could melt or burn and fail if exposed to flame or high temperatures.

This harness is comprised of nylon webbing and thread. If the harness becomes soiled, it can be washed in cold water with a mild detergent. CMC Rescue recommends the use of LifeLine Cleaner. For decontamination, the strap may be cleaned per your department's protocols on bio-hazards. Dry before stowing. Dry out of direct sunlight. Do not dry in an automatic dryer. Store in a cool, dry location.

#### REPAIR

CMC Rescue recommends that all repair work be done by the manufacturer. All other repair work or modification of the harness performed elsewhere may void the warranty, and releases CMC Rescue from all liability and responsibility as the manufacturer.

#### SAMPLE INSPECTION AND MAINTENANCE LOG

The sample log suggests records that should be maintained by the purchaser or user of rescue equipment.

Equipment Inspection and Maintenance Log			
Item _____ # _____	Date in Service _____		
Brand/Model _____	Strength _____		
Date	How Used or Maintained	Comments	Name

The **ProSeries Lifesaver™ Victim Harness** is intended for use on a victim and not as a harness for the rescuer. With proper training and adequate practice, a rescuer should be able to quickly secure a subject with the waist strap then add the leg loops for safer support. The straps are color coded to simplify connecting the correct buckle and V-Ring in order to prevent uncomfortable twists in the harness.

Before using the Lifesaver™ Harness in a high angle rescue, or training, practice putting the harness on while on the ground. As in any rescue situation, proper safety precautions and appropriate belays should be used for rescuer and subject.

#### THE USER INSTRUCTIONS

NFPA Standard 1983 recommends separating the user instructions from the harness and retaining the instructions in a permanent record. The standard also recommends making a copy of the instructions to keep with the harness and that the instructions should be referred to before and after each use.

Additional information regarding life safety harnesses can be found at least in the NFPA 1500, Standard on Fire Department Occupational Safety and Health Program and NFPA 1983, Standard on Life Safety Rope and Equipment for Emergency Services.

#### INSPECTING YOUR HARNESS

Inspect the harness according to your department's policy for inspecting life safety equipment. The harness should be inspected after each use and at least once a year by an inspector that meets your department's training standard for inspection of life safety equipment. Record the date of the inspection and the results in the equipment log or on a tag that attaches to the harness. Each user should be trained in equipment inspection and should do a cursory inspection, and check component compatibility before each use.

When inspecting the harness, check the webbing for cuts, worn or frayed areas, broken fibers, soft or hard spots, discoloration, or melted fibers. Check the stitching for pulled threads, abrasion, or breaks. Check the hardware for damage, sharp edges, and improper operation. If any of the above are noted, or if the harness has been subjected to shock loads, fall loads, or abuse other than normal use, remove the harness from service and destroy it. If there is any doubt about the serviceability of the harness, remove the harness from service and destroy it.

#### IMPORTANT INSTRUCTIONS - PLEASE READ AND SAVE



**CMC ProSeries®  
Lifesaver Victim  
Harness**

Made in USA

Part Number: 202405

Inspected by: \_\_\_\_\_ Lot#: \_\_\_\_\_ Date: \_\_\_\_\_



EMERGENCY SERVICES LIFE SAFETY HARNESS IN ACCORDANCE WITH NFPA 1983- 2006.

THIS HARNESS MEETS THE LIFE SAFETY HARNESS REQUIREMENTS OF NFPA 1983, STANDARD ON LIFE SAFETY ROPE AND EQUIPMENT FOR EMERGENCY SERVICES 2006 EDITION; CLASS II

#### CMC Rescue, Inc.

P. O. Box 6870, Santa Barbara, CA 93160 USA  
805-562-9120  
www.cmcrescue.com

**ISO 9001: 2000 Certified**

© 2002, CMC Rescue, Inc., Control No. 202405.02.092606

#### PREPARATION

After inspection, the Lifesaver™ Harness should be packed in its storage bag so that it is ready for deployment. Pull the leg V-Rings all the way to the end of the straps. Then fold and secure them with the hook and loop assembly. The V-Rings should be positioned so they can be pulled down and towards the center. Pull the waist strap V-Ring all the way to the end. Do not connect the waist buckles. Store the harness into the bag so that the waist loop (orange) is at the top.

#### PUTTING ON THE HARNESS

We recommend the following method for putting on the harness for the most common situations.

1. Pull the waist loop (orange) out of the bag. Attach a carabiner to it and clip it onto the subject's anchorage point. This could be:
  - To your descender with a Pick Off or Multi-Loop Strap.
  - To a separate rope intended for the subject.
  - To your rope with a Prusik hitch or ascender.

**In any situation, the anchorage point should be above the subject.** Tighten the drawstring so the harness does not inadvertently fall out of the bag.
2. Position yourself to a position adjacent to the subject.
3. Pull the drawstring to open the bag and remove the harness completely out of the bag. Hold the waist buckle in your left hand. The waist loop (orange) should be next to your wrist. The "CMC" label should be towards the subject.
4. Reach around and clip the waist V-Ring into its buckle. Center the waist loop (orange) to the subject's front and tighten the waist belt snugly. Take up any slack in the subject's belay.
5. Pull the leg loops down, between the legs, and to the outside of the subject's body.
6. Clip the V-Rings into the buckles of the matching color. Pull the ends to tighten so the leg loops fit snugly. If you are concerned about the buckles slipping, tie an overhand knot in the end of all the straps.
7. Check the following:
  - The V-Rings are securely clipped into each buckle.
  - The harness is snug but not pinching or binding.
  - The buckles are not causing the subject any discomfort.
  - All carabiners are locked.
  - The slack is out of the system.



# RESCUE SYSTEMS 1

## Basic Rescue Skills

### Appendix E: Victim Pelvic Harness Information Card





---

# RESCUE SYSTEMS 1

## Basic Rescue Skills

---

### Topic 6-9: Introduction to the Cutting Station

---

